

TCR22-x Series

RoHS

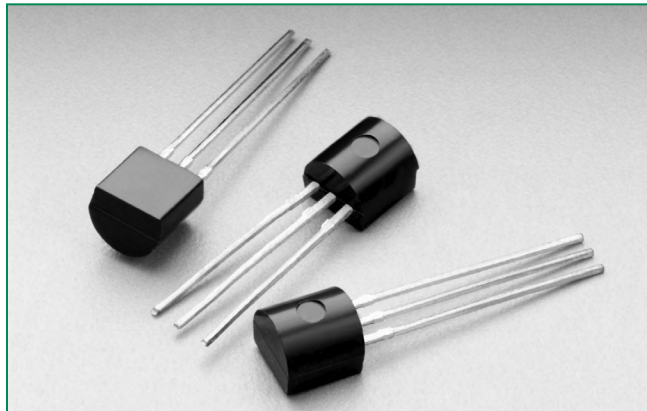

Description

Excellent unidirectional switches for phase control applications such as heating and motor speed controls. Sensitive gate SCRs are easily triggered with microAmps of current as furnished by sense coils, proximity switches, and microprocessors.

Features & Benefits

- RoHS compliant
- Glass – passivated junctions
- Voltage capability up to 600 V
- Surge capability up to 20 A

Applications

Typical applications are capacitive discharge systems for strobe lights and gas engine ignition. Also controls for power tools, home/brown goods and white goods appliances.

Main Features

Symbol	Value	Unit
$I_{T(RMS)}$	1.5	A
V_{DRM}/V_{RRM}	400 to 600	V
I_{GT}	200	μA

Additional Information



Datasheet



Resources



Samples

Schematic Symbol

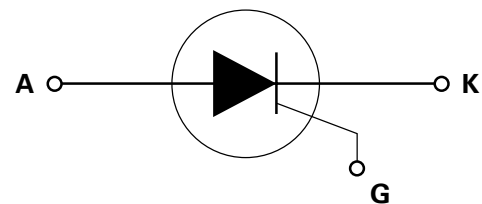

Absolute Maximum Ratings – Sensitive SCRs

Symbol	Parameter	Test Conditions	Value	Unit
$I_{T(RMS)}$	RMS on-state current	$T_C = 40^\circ C$	1.5	A
$I_{T(AV)}$	Average on-state current	$T_C = 40^\circ C$	0.95	A
I_{TSM}	Peak non-repetitive surge current	single half cycle; $f = 50\text{Hz}$; $T_J(\text{initial}) = 25^\circ C$	16	A
		single half cycle; $f = 60\text{Hz}$; $T_J(\text{initial}) = 25^\circ C$	20	
I^2t	I^2t Value for fusing	$t_p = 8.3 \text{ ms}$	1.6	A^2s
di/dt	Critical rate of rise of on-state current	$f = 60 \text{ Hz}; T_J = 110^\circ C$	50	$A/\mu s$
I_{GM}	Peak gate current	$T_J = 110^\circ C$	1	A
$P_{G(AV)}$	Average gate power dissipation	$T_J = 110^\circ C$	0.1	W
T_{stg}	Storage temperature range		-40 to 150	$^\circ C$
T_J	Operating junction temperature range		-40 to 110	$^\circ C$

Electrical Characteristics (T_J = 25°C, unless otherwise specified)

Symbol	Test Conditions			Value	Unit	
I _{GT}	V _D = 6V; R _L = 100 Ω			MAX.	200	μA
V _{GT}	V _D = 6V; R _L = 100 Ω			MAX.	0.8	V
dv/dt	V _D = V _{DRM} ; R _{GK} = 1kΩ	400V	MIN.		40	V/μs
		600V			30	
V _{GD}	V _D = V _{DRM} ; R _L = 3.3 kΩ; T _J = 110°C			MIN.	0.25	V
V _{GRM}	I _{GR} = 10μA			MIN.	6	V
I _H	I _T = 200mA (initial)			MAX.	5	mA
t _q	(1)			MAX.	50	μs
t _{gt}	I _G = 2 × I _{GT} ; PW = 15μs; I _T = 3A			TYP.	20	μs

(1) I_T=1A; t_p=50μs; dv/dt=5V/μs; di/dt=-10A/μs

Static Characteristics

Symbol	Test Conditions			Value	Unit	
V _{TM}	I _T = 3A; t _p = 380 μs			MAX.	1.5	V
I _{DRM} / I _{RRM}	V _{DRM} = V _{RRM}	T _J = 25°C	400V	MAX.	1	μA
			600V		2	
		T _J = 110°C			100	

Thermal Resistances

Symbol	Parameter	Value	Unit
R _{θ(J-C)}	Junction to case (AC)	50	°C/W
R _{θ(J-A)}	Junction to ambient	160	°C/W

Figure 1: Normalized DC Gate Trigger Current vs. Junction Temperature

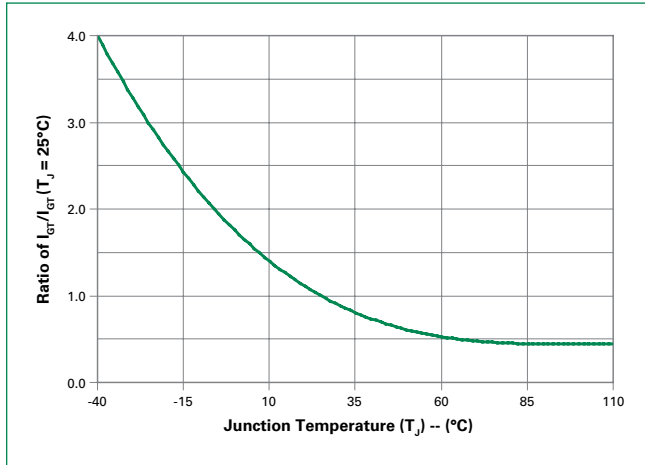

Figure 2: Normalized DC Gate Trigger Voltage vs. Junction Temperature

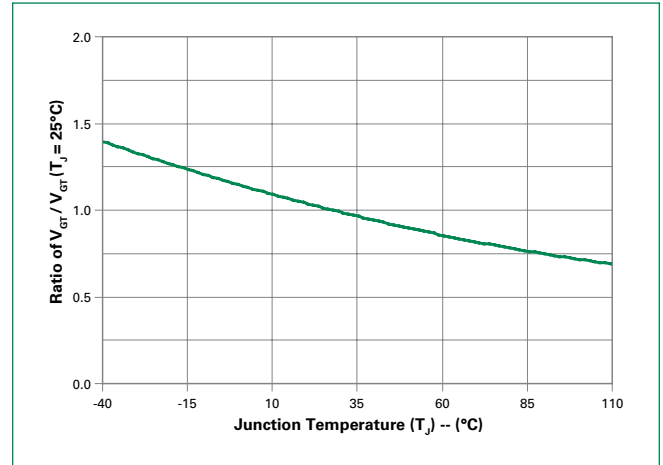

Figure 3: Normalized DC Holding Current vs. Junction Temperature

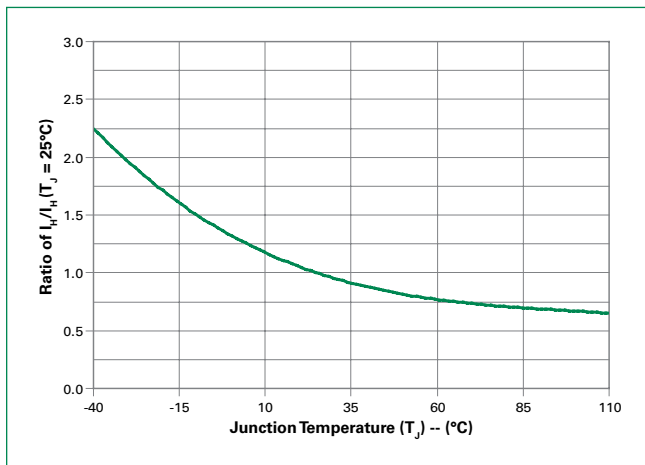

Figure 4: Normalized DC Latching Current vs. Junction Temperature

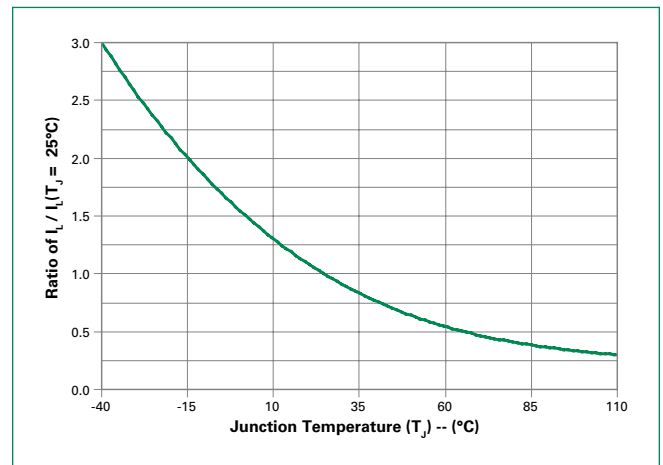

Figure 5: On-State Current vs. On-State Voltage (Typical)

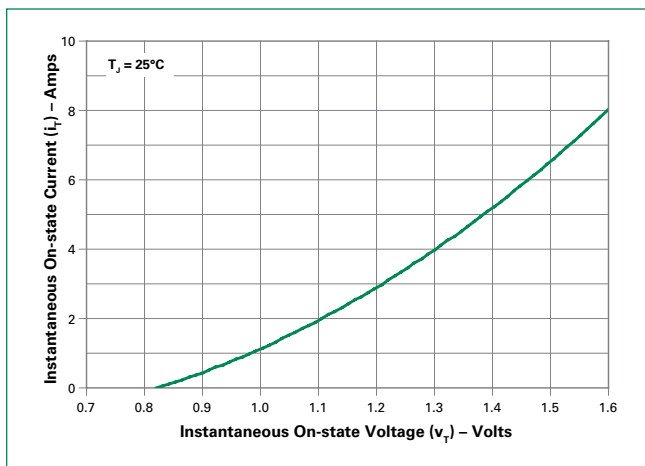

Figure 6: Power Dissipation (Typical) vs. RMS On-State Current

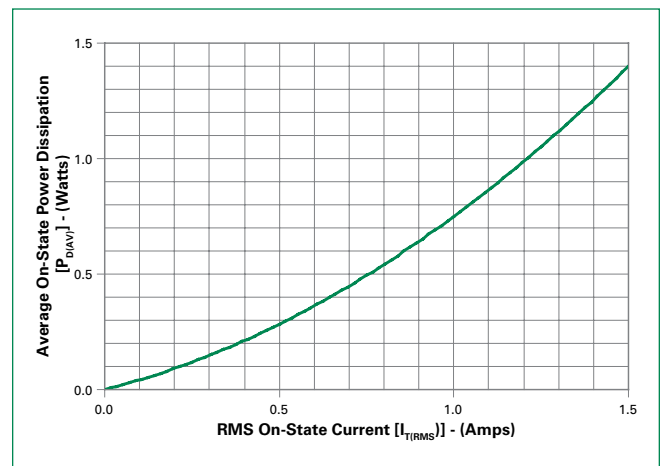

Figure 7: Maximum Allowable Case Temperature vs. RMS On-State Current

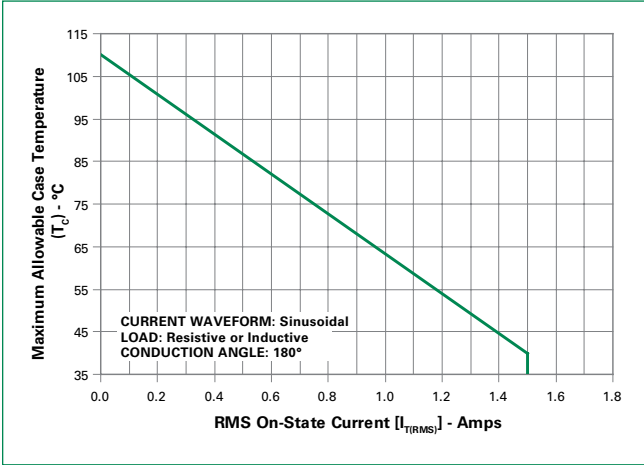

Figure 8: Maximum Allowable Case Temperature vs. Average On-State Current

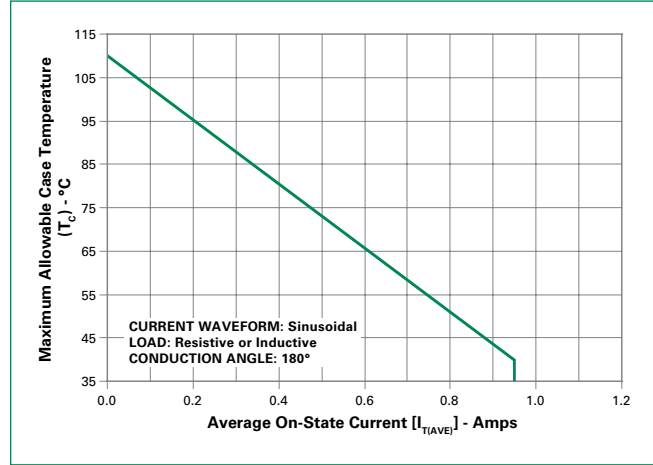

Figure 9: Maximum Allowable Ambient Temperature vs. RMS On-State Current

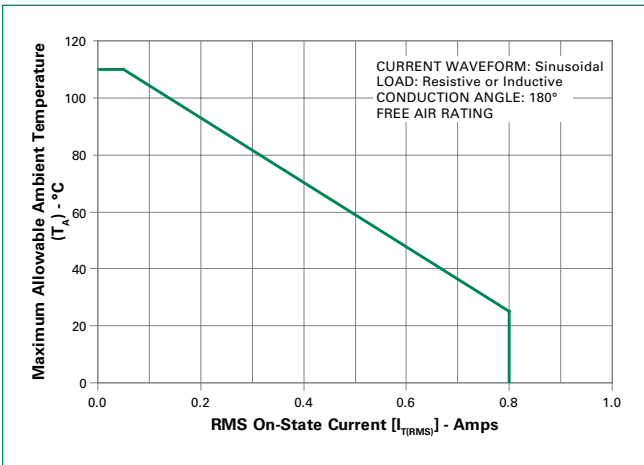

Figure 10: Maximum Allowable Ambient Temperature vs. Average On-State Current

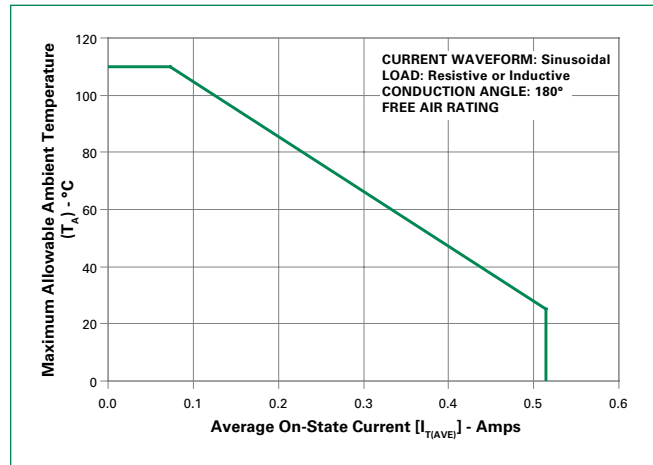

Figure 11: Peak Repetitive Capacitor Discharge Current

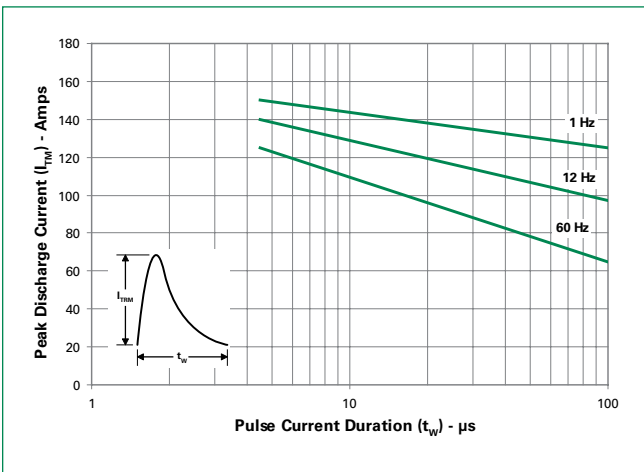

Figure 12: Peak Repetitive Sinusoidal Pulse Current

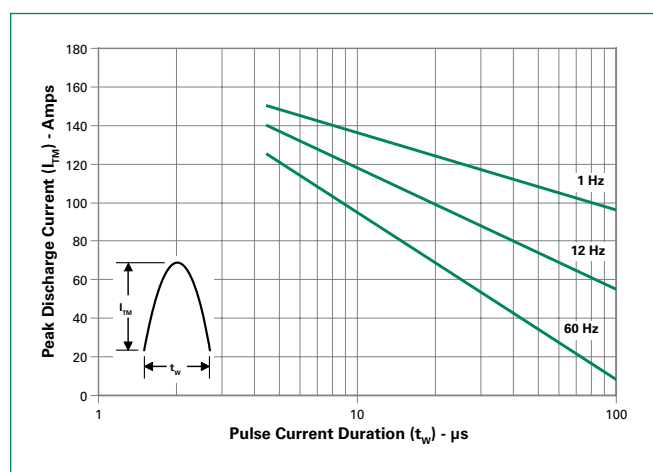

Figure 13: Surge Peak On-State Current vs. Number of Cycles

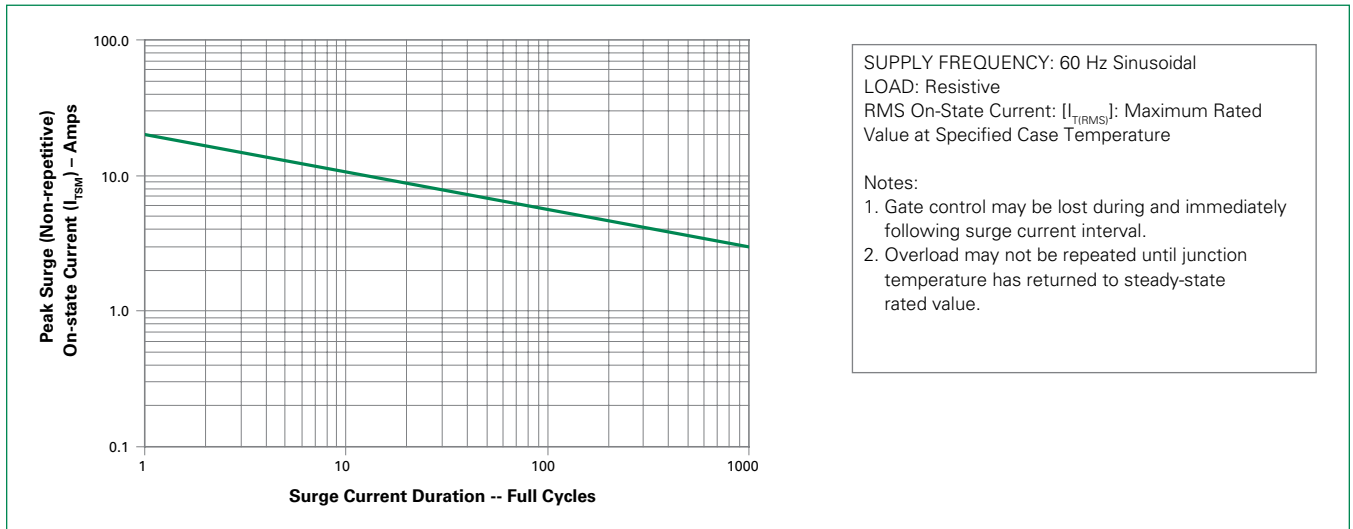
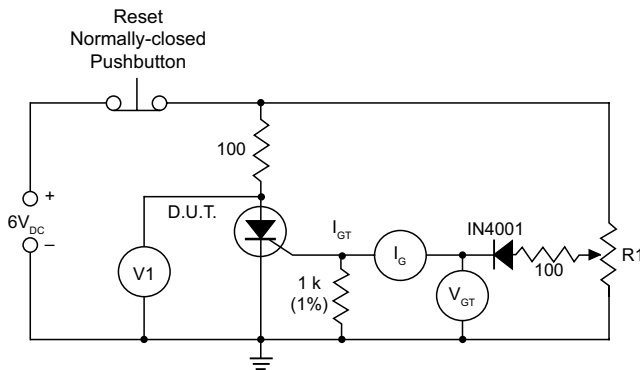

Figure 14: Simple Test Circuit for Gate Trigger Voltage and Current



Note: V1 — 0 V to 10 V dc meter
V_{GT} — 0 V to 1 V dc meter
I_G — 0 mA to 1 mA dc milliammeter
R1 — 1 k potentiometer

To measure gate trigger voltage and current, raise gate voltage (V_{GT}) until meter reading V1 drops from 6 V to 1 V. Gate trigger voltage is the reading on V_{GT} just prior to V1 dropping. Gate trigger current I_{GT} can be computed from the relationship

$$I_{GT} = I_G - \frac{V_{GT}}{1000} \text{ Amps}$$

where I_G is reading (in amperes) on meter just prior to V1 dropping

Note: I_{GT} may turn out to be a negative quantity (trigger current flows out from gate lead). If negative current occurs, I_{GT} value is not a valid reading. Remove 1 k resistor and use I_G as the more correct I_{GT} value. This will occur on 12 μA gate products.

Soldering Parameters

Reflow Condition		Pb – Free assembly
Pre Heat	- Temperature Min ($T_{s(min)}$)	150°C
	- Temperature Max ($T_{s(max)}$)	200°C
	- Time (min to max) (t_s)	60 – 180 secs
Average ramp up rate (Liquidus Temp) (T_L) to peak		5°C/second max
$T_{s(max)}$ to T_L - Ramp-up Rate		5°C/second max
Reflow	- Temperature (T_L) (Liquidus)	217°C
	- Temperature (t_l)	60 – 150 seconds
Peak Temperature (T_p)		260 ^{+0/-5} °C
Time within 5°C of actual peak Temperature (t_p)		20 – 40 seconds
Ramp-down Rate		5°C/second max
Time 25°C to peak Temperature (T_p)		8 minutes Max.
Do not exceed		280°C

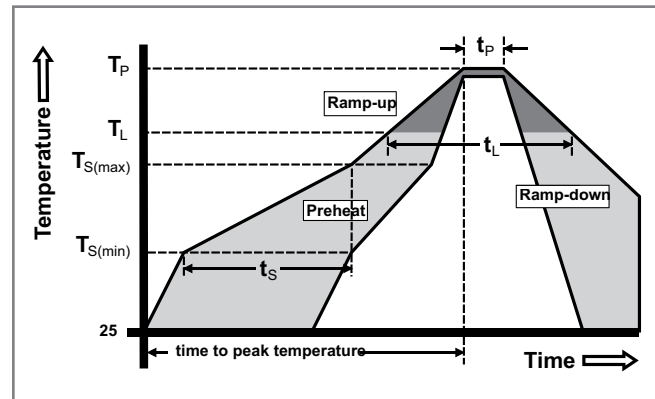

Physical Specifications

Terminal Finish	100% Matt Tin-plated/Pb-free Solder Dipped
Body Material	UL recognized epoxy meeting flammability classification 94V-0
Lead Material	Copper Alloy

Design Considerations

Careful selection of the correct device for the application's operating parameters and environment will go a long way toward extending the operating life of the Thyristor. Good design practice should limit the maximum continuous current through the main terminals to 75% of the device rating. Other ways to ensure long life for a power discrete semiconductor are proper heat sinking and selection of voltage ratings for worst case conditions. Overheating, overvoltage (including dv/dt), and surge currents are the main killers of semiconductors. Correct mounting, soldering, and forming of the leads also help protect against component damage.

Environmental Specifications

Test	Specifications and Conditions
AC Blocking	MIL-STD-750, M-1040, Cond A Applied Peak AC voltage @ 110°C for 1008 hours
Temperature Cycling	MIL-STD-750, M-1051, 100 cycles; -40°C to +150°C; 15-min dwell-time
Temperature/Humidity	EIA / JEDEC, JESD22-A101 1008 hours; 320V - DC: 85°C; 85% rel humidity
High Temp Storage	MIL-STD-750, M-1031, 1008 hours; 150°C
Low-Temp Storage	1008 hours; -40°C
Resistance to Solder Heat	MIL-STD-750 Method 2031
Solderability	ANSI/J-STD-002, category 3, Test A
Lead Bend	MIL-STD-750, M-2036 Cond E

Dimensions – TO-92 (E Package)

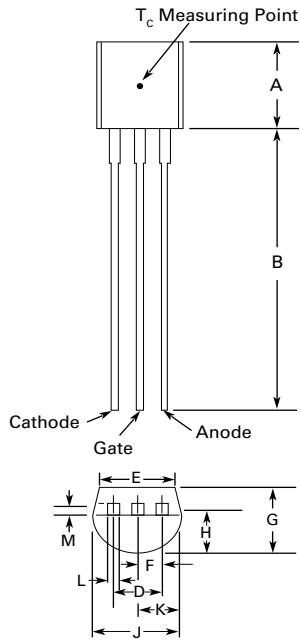

Dimension	Inches		Millimeters	
	Min	Max	Min	Max
A	0.176	0.196	4.47	4.98
B	0.500		12.70	
D	0.095	0.105	2.41	2.67
E	0.150		3.81	
F	0.046	0.054	1.16	1.37
G	0.135	0.145	3.43	3.68
H	0.088	0.096	2.23	2.44
J	0.176	0.186	4.47	4.73
K	0.088	0.096	2.23	2.44
L	0.013	0.019	0.33	0.48
M	0.013	0.017	0.33	0.43

All leads insulated from case. Case is electrically nonconductive.

Product Selector

Part Number	Voltage				Gate Sensitivity	Type	Package
	400V	600V	800V	1000V			
TCR22-6	X				200µA	Sensitive SCR	TO-92
TCR22-8		X			200µA	Sensitive SCR	TO-92

Note: x = Voltage

Packing Options

Part Number	Marking	Weight	Packing Mode	Base Quantity
TCR22-x	TCR22-x	0.19 g	Bulk	2000
TCR22-xRP	TCR22-x	0.19 g	Reel Pack	2000
TCR22-xAP	TCR22-x	0.19 g	Ammo Pack	2000

Note: x = Voltage

Part Numbering System

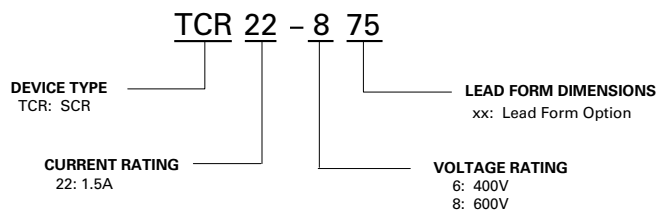

Part Marking System

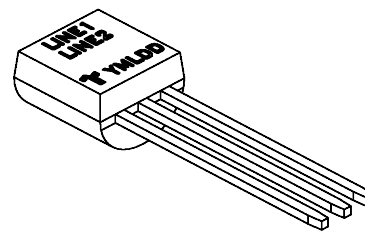

Line1 = Littelfuse Part Number
Line2 = continuation...Littelfuse Part Number
Y = Last Digit of Calendar Year
M = Letter Month Code (A-L for Jan-Dec)
L = Location Code
DD = Calendar Date

TO-92 (3-lead) Reel Pack (RP) Radial Leaded Specifications

Meets all EIA-468-C Standards

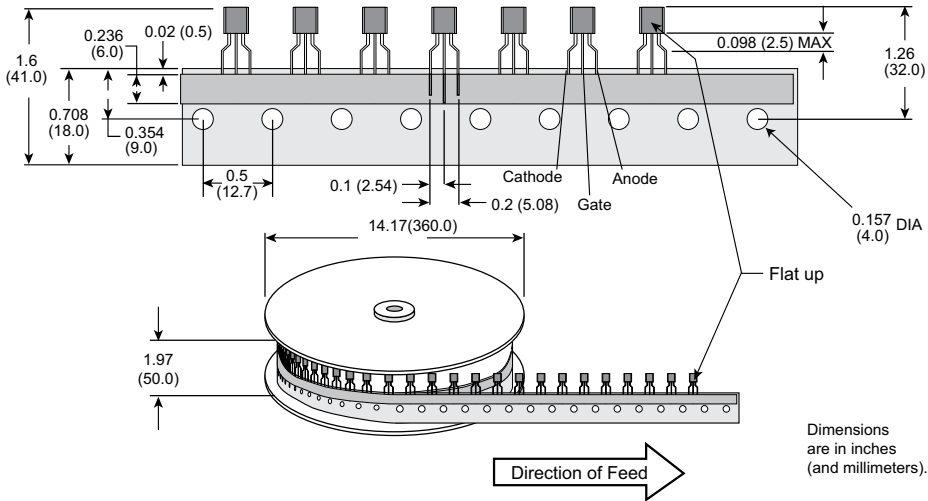

TO-92 (3-lead) Ammo Pack (AP) Radial Leaded Specifications

Meets all EIA-468-C Standards

