

1 Form A Solid-State Relay

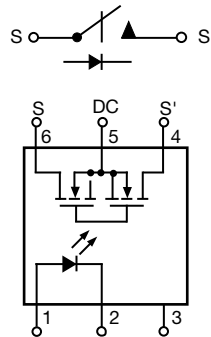

FEATURES

- Extremely low operating current
- High speed operation
- Isolation test voltage 5300 V_{RMS}
- Current limit protection
- High surge capability
- DC only option
- Clean bounce free switching
- Low power consumption
- Surface mountable
- Material categorization: For definitions of compliance please see www.vishay.com/doc?99912

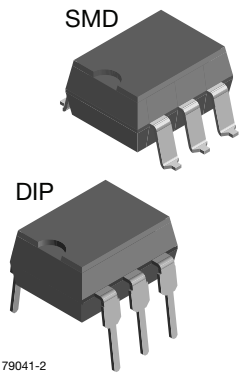

RoHS
COMPLIANT

DESCRIPTION

The LH1525 relay are SPST normally open switches (1 form A) that can replace electromechanical relays in many applications. The relay requires a minimal amount of LED drive current to operate, making it ideal for battery powered and power consumption sensitive applications. The relay is constructed using a GaAlAs LED for actuation control and an integrated monolithic die for the switch output. The die, fabricated in a high-voltage dielectrically isolated technology, comprised of a photodiode array, switch-control circuitry, and MOSFET switches. In addition, the relay employs current-limiting circuitry, enabling it to pass lightning surge testing as per ANSI/TIA-968-B and other regulatory surge requirements when overvoltage protection is provided. The relay can be configured for AC/DC or DC-only operation.

APPLICATIONS

- General telecom switching
- Battery powered switch applications
- Industrial controls
- Programmable controllers
- Instrumentation

Note

- See "solid-state relays" (application note 56)

AGENCY APPROVALS

- UL1577 file no. E52744 system code H, double protection
- CSE certification 093751
- BSI no. 7979, BSI no. 7980
- FIMKO 25149

ORDERING INFORMATION

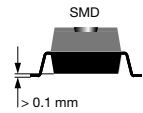
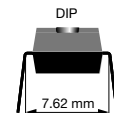
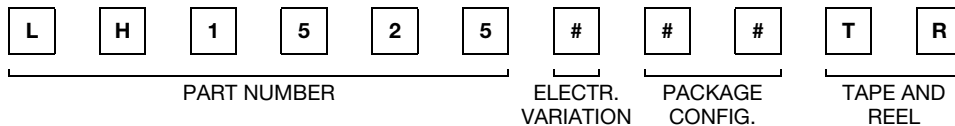

PACKAGE	
SMD-6, tubes	LH1525AAB
SMD-6, tape and reel	LH1525AABTR
DIP-6, tubes	LH1525AT



ABSOLUTE MAXIMUM RATINGS ($T_{amb} = 25\text{ }^{\circ}\text{C}$, unless otherwise specified)				
PARAMETER	TEST CONDITION	SYMBOL	VALUE	UNIT
INPUT				
LED input ratings: continuous forward current		I_F	50	mA
LED input ratings: reverse voltage		V_R	8	V
OUTPUT				
Output operation (each channel): DC or peak AC load voltage	$I_L \leq 50\text{ }\mu\text{A}$	V_L	400	V
Continuous DC load current, bidirectional operation pin 4 to 6		I_L	125	mA
Continuous DC load current, unidirectional operation pins 4, 6 (+) to pin 5 (-)		I_L	250	mA
SSR				
Ambient operating temperature range		T_{amb}	- 40 to + 85	$^{\circ}\text{C}$
Storage temperature range		T_{stg}	- 40 to + 150	$^{\circ}\text{C}$
Pin soldering temperature ⁽¹⁾	$t = 10\text{ s max.}$	T_{sld}	260	$^{\circ}\text{C}$
Input to output isolation test voltage	$t = 1\text{ s}$	V_{ISO}	5300	V_{RMS}
Power dissipation		P_{diss}	550	mW

Notes

- Stresses in excess of the absolute maximum ratings can cause permanent damage to the device. Functional operation of the device is not implied at these or any other conditions in excess of those given in the operational sections of this document. Exposure to absolute maximum ratings for extended periods of the time can adversely affect reliability.

⁽¹⁾ Refer to reflow profile for soldering conditions for surface mounted devices (SMD). Refer to wave profile for soldering conditions for through hole devices (DIP).

ELECTRICAL CHARACTERISTICS ($T_{amb} = 25\text{ }^{\circ}\text{C}$, unless otherwise specified)						
PARAMETER	TEST CONDITION	SYMBOL	MIN.	TYP.	MAX.	UNIT
INPUT						
LED forward current, switch turn-on	$I_L = 100\text{ mA}$, $t = 10\text{ ms}$	I_{Fon}		0.33	0.5	mA
LED forward current, switch turn-off	$V_L = \pm 350\text{ V}$, $t = 100\text{ ms}$	I_{Foff}	0.001	0.23		mA
LED forward voltage	$I_F = 1.5\text{ mA}$	V_F	0.8	1.16	1.40	V
OUTPUT						
On-resistance, AC/DC, each pole	$I_F = 1.5\text{ mA}$, $I_L = \pm 50\text{ mA}$	R_{ON}	17	26	36	Ω
On-resistance, DC: pin 4, 6 (+) to 5 (-)	$I_F = 1.5\text{ mA}$, $I_L = 100\text{ mA}$	R_{ON}	4.25	7	8.25	Ω
Off-resistance	$I_F = 0\text{ mA}$, $V_L = \pm 100\text{ V}$	R_{OFF}		2000		G Ω
Current limit AC ⁽¹⁾ : pin 4 (\pm) to 6 (\pm)	$I_F = 1.5\text{ mA}$, $t = 5\text{ ms}$, $V_L = 7\text{ V}$	I_{LMT}	170	185	270	mA
Off-state leakage current	$I_F = 0\text{ mA}$, $V_L = \pm 100\text{ V}$	I_O		0.67	200	nA
	$I_F = 0\text{ mA}$, $V_L = \pm 400\text{ V}$	I_O		0.096	1	μA
Output capacitance	$I_F = 0\text{ mA}$, $V_L = 1\text{ V}$	C_O		22		pF
	$I_F = 0\text{ mA}$, $V_L = 50\text{ V}$	C_O		6.42		pF
Switch offset	$I_F = 5\text{ mA}$	V_{OS}		0.2		μV
TRANSFER						
Capacitance (input to output)	$V_{ISO} = 1\text{ V}$	C_{IO}		0.75		pF

Notes

- Minimum and maximum values are testing requirements. Typical values are characteristics of the device and are the result of engineering evaluations. Typical values are for information only and are not part of the testing requirements.

⁽¹⁾ No DC mode current limit available.

SWITCHING CHARACTERISTICS ($T_{amb} = 25\text{ }^{\circ}\text{C}$, unless otherwise specified)						
PARAMETER	TEST CONDITION	SYMBOL	MIN.	TYP.	MAX.	UNIT
Turn-on time	$I_F = 1.5\text{ mA}$, $I_L = 50\text{ mA}$	t_{on}		1.25		ms
	$I_F = 5\text{ mA}$, $I_L = 50\text{ mA}$	t_{on}		0.22	1	ms
Turn-off time	$I_F = 1.5\text{ mA}$, $I_L = 50\text{ mA}$	t_{off}		0.6		ms
	$I_F = 5\text{ mA}$, $I_L = 50\text{ mA}$	t_{off}		1.1	1.5	ms



SAFETY AND INSULATION RATINGS				
PARAMETER	TEST CONDITION	SYMBOL	VALUE	UNIT
Climatic classification	IEC 68 part 1		40/85/21	
Pollution degree	DIN VDE 0109		2	
Tracking resistance (comparative tracking index)	Insulation group IIIa	CTI	175	
Highest allowable overvoltage	Transient overvoltage	V_{IOTM}	8000	V_{peak}
Max. working insulation voltage	Recurring peak voltage	V_{IORM}	890	V_{peak}
Insulation resistance at 25 °C	$V_{IO} = 500 V$	R_{IS}	$\geq 10^{12}$	W
Insulation resistance at T_S		R_{IS}	$\geq 10^9$	W
Insulation resistance at 100 °C		R_{IS}	$\geq 10^{11}$	W
Partial discharge test voltage	Method e, $V_{pd} = V_{IORM} \times 1.875$	V_{pd}	1669	V_{peak}
Safety limiting values - maximum values allowed in the event of a failure	Case temperature	T_{SI}	175	°C
	Input current	I_{SI}	300	mA
	Output power	P_{SO}	700	mW
Minimum external air gap (clearance)	Measured from input terminals to output terminals, shortest distance through air		≥ 7	mm
Minimum external tracking (creepage)	Measured from input terminals to output terminals, shortest distance path along body		≥ 7	mm
Insulation thickness			≥ 0.4	mm

TYPICAL CHARACTERISTICS ($T_{amb} = 25\text{ °C}$, unless otherwise specified)

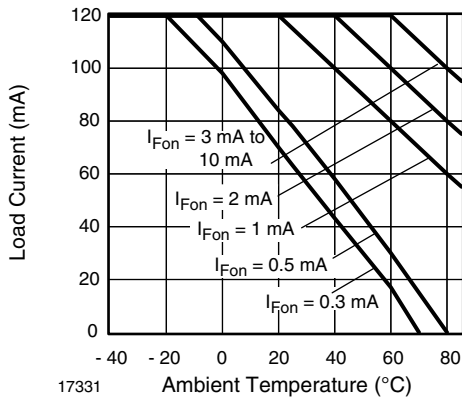

Fig. 1 - Recommended Operating Conditions

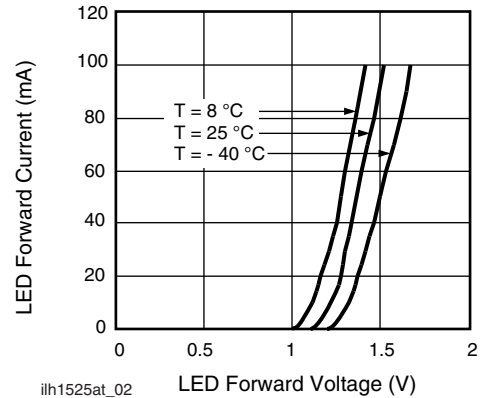

Fig. 3 - LED Forward Current vs. Forward Voltage

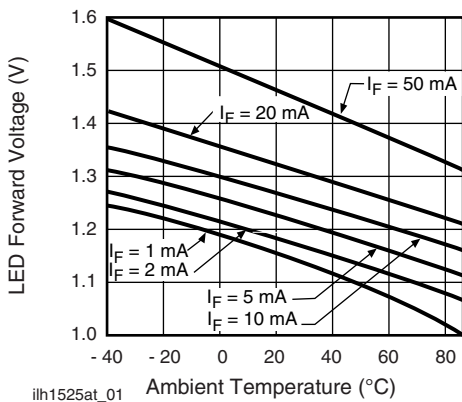

Fig. 2 - LED Voltage vs. Temperature

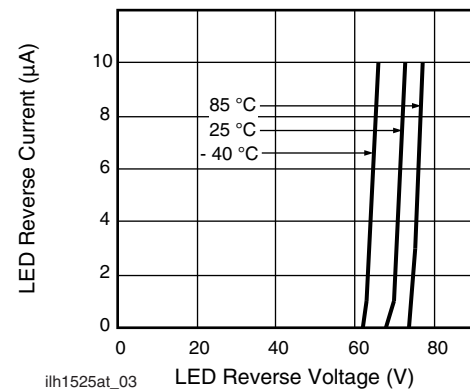

Fig. 4 - LED Reverse Current vs. LED Reverse Voltage

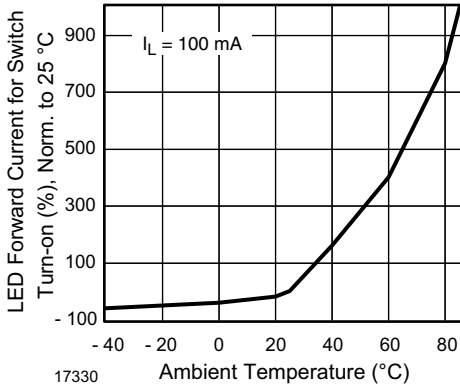

Fig. 5 - LED Current for Switch Turn-on vs. Temperature

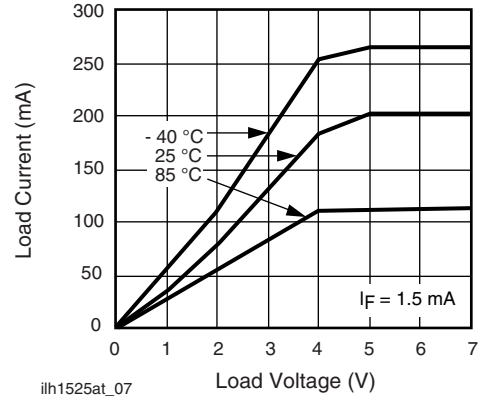

Fig. 8 - Load Current vs. Load Voltage

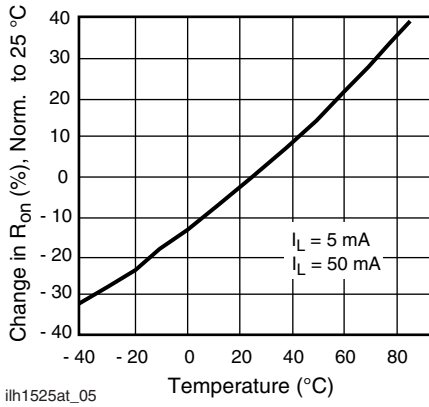

Fig. 6 - On-Resistance vs. Temperature

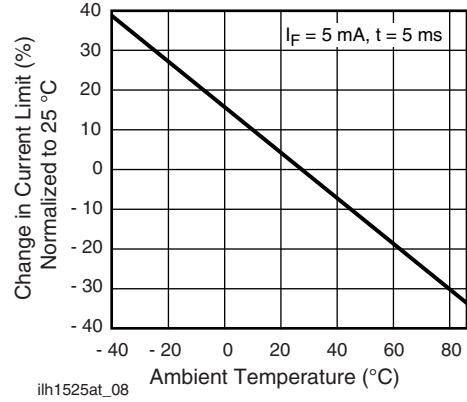

Fig. 9 - Current Limit vs. Temperature

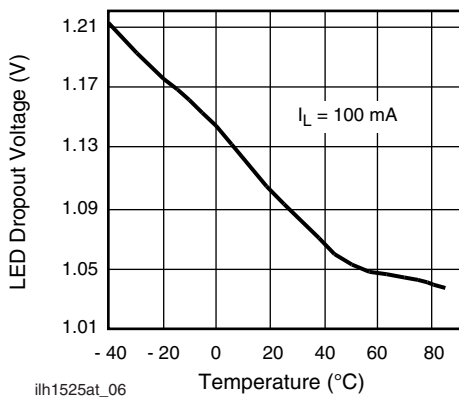

Fig. 7 - LED Dropout Voltage vs. Temperature

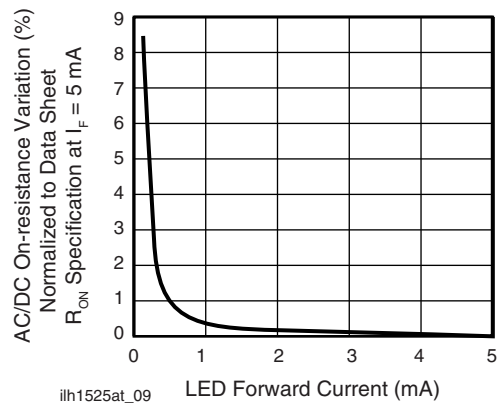

Fig. 10 - Variation in On-resistance vs. LED Current

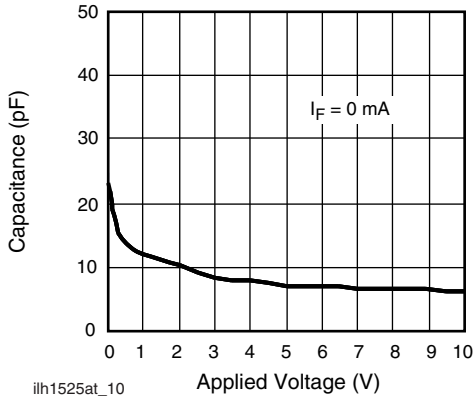

Fig. 11 - Switch Capacitance vs. Applied Voltage

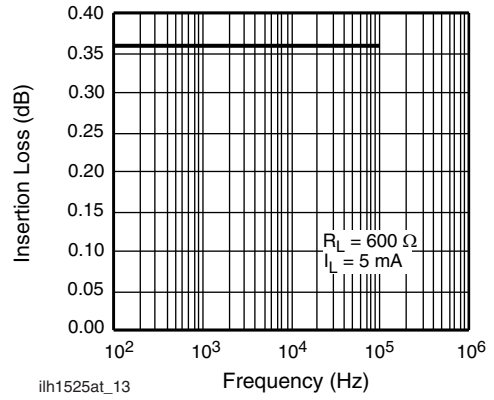

Fig. 14 - Insertion Loss vs. Frequency

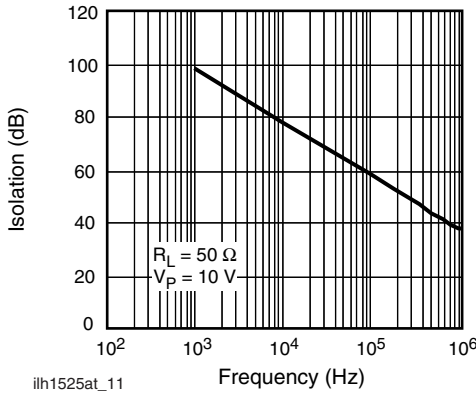

Fig. 12 - Output Isolation

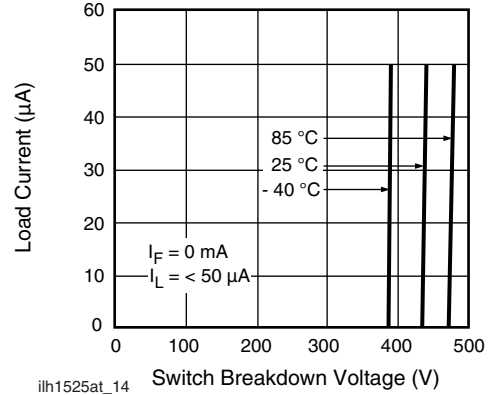

Fig. 15 - Switch Breakdown Voltage vs. Load Current

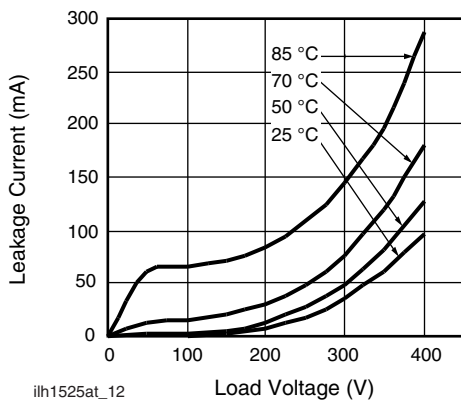

Fig. 13 - Leakage Current vs. Applied Voltage at Elevated Temperatures

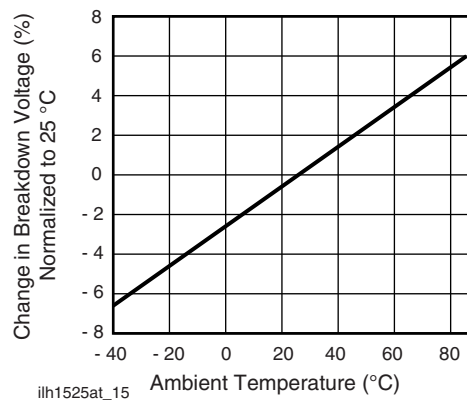

Fig. 16 - Switch Breakdown Voltage vs. Temperature

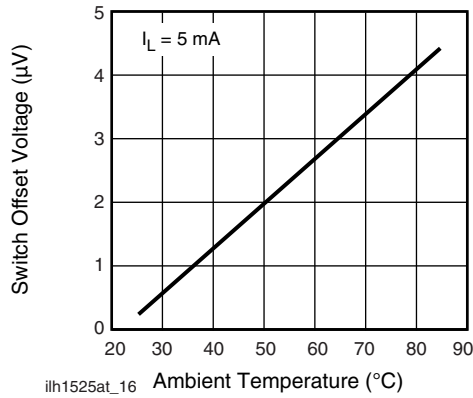

Fig. 17 - Switch Offset Voltage vs. Temperature

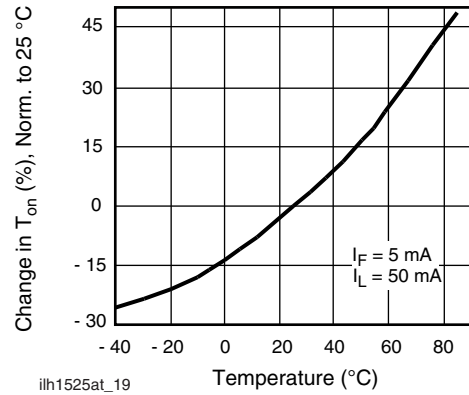

Fig. 20 - Turn-off Time vs. Temperature

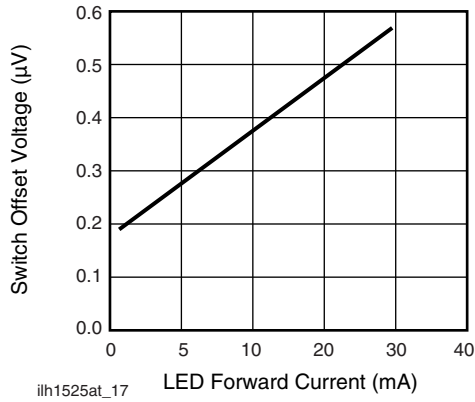

Fig. 18 - LED Offset Voltage vs. LED Current

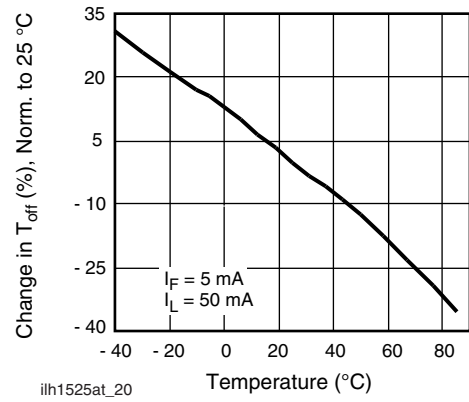

Fig. 21 - Turn-on Time vs. LED Temperature

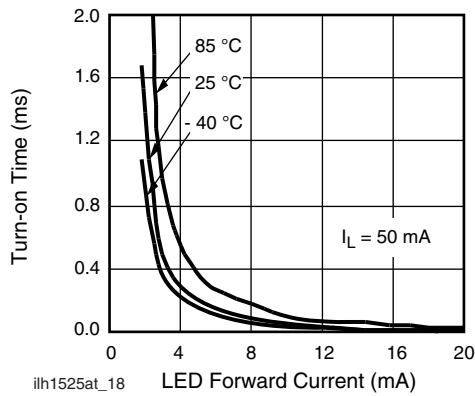

Fig. 19 - Turn-on Time vs. LED Current

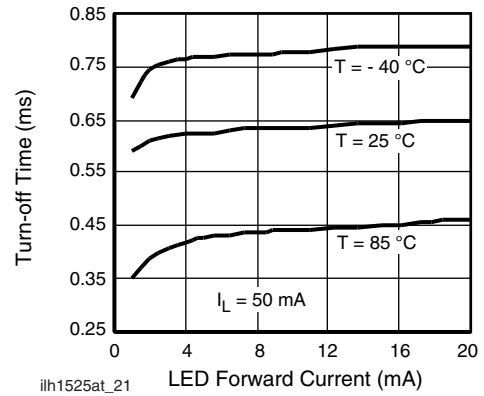

Fig. 22 - Turn-off Time vs. LED Current

APPLICATIONS

INPUT CONTROL

The LH1525 low turn-on current SSR has highly sensitive photodetection circuits that will detect even the most minute currents flowing through the LED. Leakage current must be considered when designing a circuit to turn on and off these relays.

Figure 23 shows a typical logic circuit for providing LED drive current. R_1 is the input resistor that limits the amount of current flowing through the LED. For 5 V operation, a 2700 Ω resistor will limit the drive current to about 1.4 mA. Where high-speed actuation is desirable, use a lower value resistor for R_1 . An additional RC peaking circuit is not required with the LH1525 relay.

R_2 is an optional pull-up resistor which pulls the logic level high output (V_{OH}) up toward the V_S potential. The pull-up resistance is set at a high value to minimize the overall current drawn from the V_S . The primary purpose of this resistor is to keep the differential voltage across the LED below its turn-on threshold. LED dropout voltage is graphed vs. temperature in the typical performance characteristics section. When the logic gate is high, leakage current will flow through R_2 . R_2 will draw up to 8 mA before developing a voltage potential which may possibly turn on the LED.

Each application should be evaluated, over the full operating temperature range to make sure that leakage current through the input control LED is kept to a value less than the minimum LED forward current for switch turn-off specification.

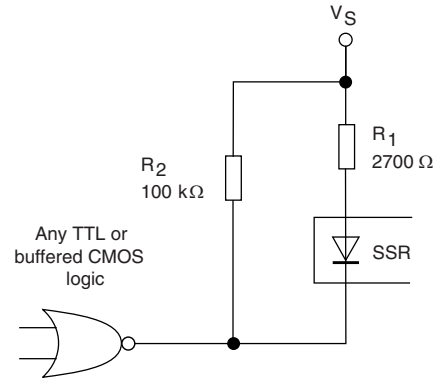

ilh1525at_22

Fig. 23 - Input Control Circuit

PACKAGE DIMENSIONS in millimeters

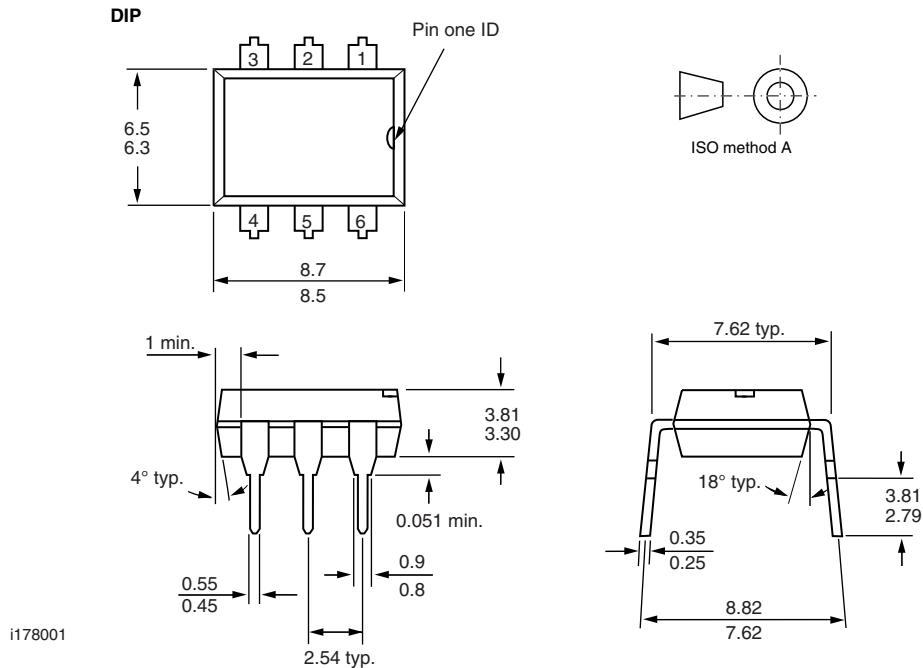

i178001

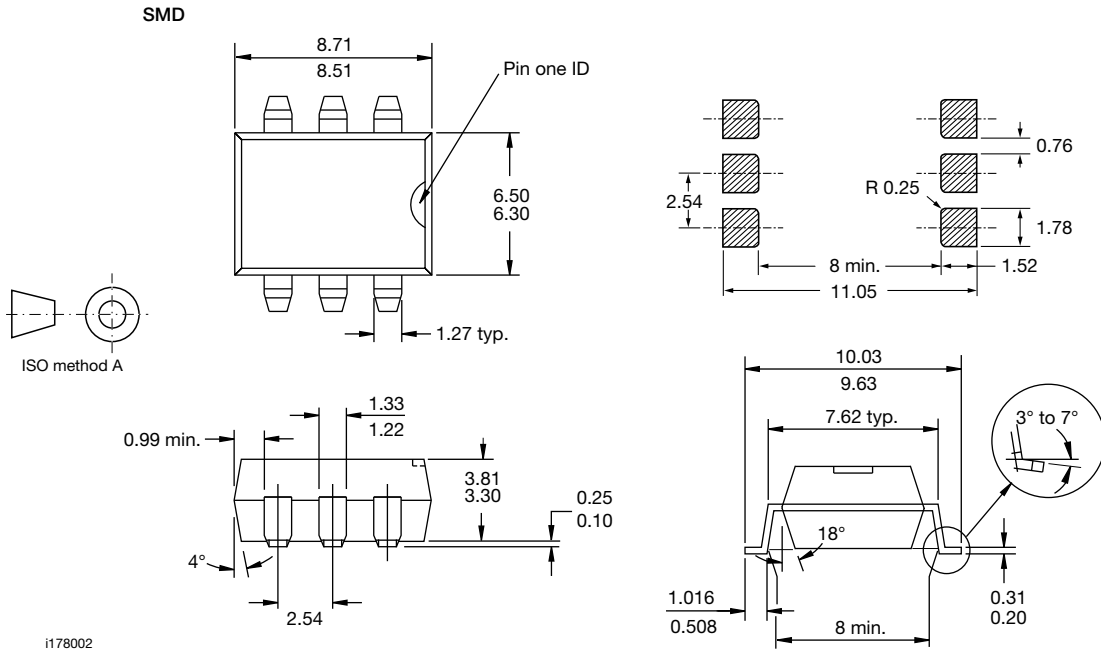

PACKAGE MARKING

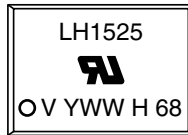

Note

- Tape and reel suffix (TR) is not part of the package marking.



Disclaimer

ALL PRODUCT, PRODUCT SPECIFICATIONS AND DATA ARE SUBJECT TO CHANGE WITHOUT NOTICE TO IMPROVE RELIABILITY, FUNCTION OR DESIGN OR OTHERWISE.

Vishay Intertechnology, Inc., its affiliates, agents, and employees, and all persons acting on its or their behalf (collectively, "Vishay"), disclaim any and all liability for any errors, inaccuracies or incompleteness contained in any datasheet or in any other disclosure relating to any product.

Vishay makes no warranty, representation or guarantee regarding the suitability of the products for any particular purpose or the continuing production of any product. To the maximum extent permitted by applicable law, Vishay disclaims (i) any and all liability arising out of the application or use of any product, (ii) any and all liability, including without limitation special, consequential or incidental damages, and (iii) any and all implied warranties, including warranties of fitness for particular purpose, non-infringement and merchantability.

Statements regarding the suitability of products for certain types of applications are based on Vishay's knowledge of typical requirements that are often placed on Vishay products in generic applications. Such statements are not binding statements about the suitability of products for a particular application. It is the customer's responsibility to validate that a particular product with the properties described in the product specification is suitable for use in a particular application. Parameters provided in datasheets and / or specifications may vary in different applications and performance may vary over time. All operating parameters, including typical parameters, must be validated for each customer application by the customer's technical experts. Product specifications do not expand or otherwise modify Vishay's terms and conditions of purchase, including but not limited to the warranty expressed therein.

Except as expressly indicated in writing, Vishay products are not designed for use in medical, life-saving, or life-sustaining applications or for any other application in which the failure of the Vishay product could result in personal injury or death. Customers using or selling Vishay products not expressly indicated for use in such applications do so at their own risk. Please contact authorized Vishay personnel to obtain written terms and conditions regarding products designed for such applications.

No license, express or implied, by estoppel or otherwise, to any intellectual property rights is granted by this document or by any conduct of Vishay. Product names and markings noted herein may be trademarks of their respective owners.