

## Multilayer Varistor for ESD pulse [DC voltage lines/High speed signal lines]

Series: **EZJZ, EZJP**

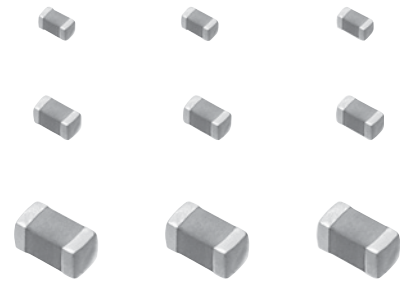

### Features

- Excellent ESD suppression due to original advanced material technology
- Having large electrostatic resistance meeting IEC61000-4-2, Level 4 standard
- Having no polarity (bipolar) facilitated replacing Zener Diodes. Capable of replacing 2 Zener Diodes and 1 Capacitor.
- Lead-free plating terminal electrodes enabling great solderability
- Wide range of products is available by adopting multilayer structure, meeting various needs.
- Low capacitance versions for DC voltage lines of high speed busses
- Ultra low capacitance for high speed signal line
- Applicable to high-speed signal lines, such as interfaces (e.g. USB 2.0, IEEE1394, HDMI, and so on), due to our original ultra-low capacitance technology.
- RoHS compliant

### As for Packaging Methods, Handling Precautions

Please see Data Files

### Explanation of Part Numbers

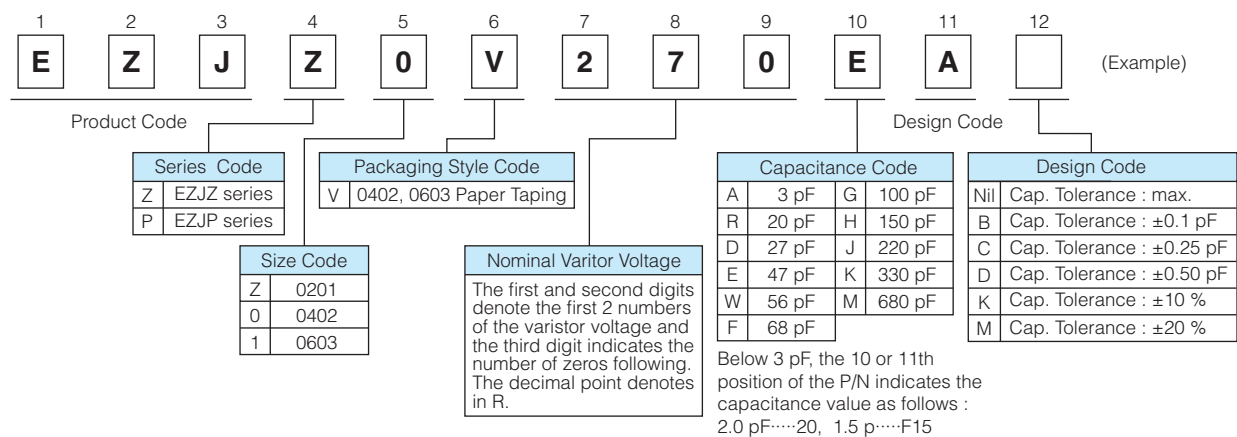

### Construction

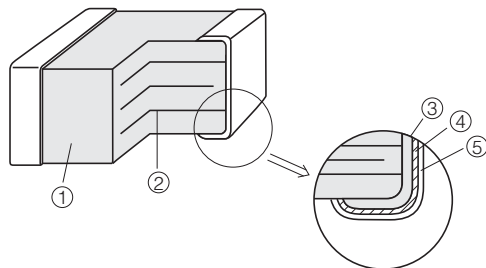

No.	Name
①	Semiconductive Ceramics
②	Internal electrode
③	Substrate electrode
④	Terminal electrode
⑤	Intermediate electrode
	External electrode

### Dimensions in mm (not to scale)

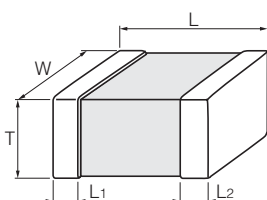

Size Code	Size(inch)	L	W	T	L <sub>1</sub> , L <sub>2</sub>
Z	0201	0.60±0.03	0.30±0.03	0.30±0.03	0.15±0.05
0	0402	1.00±0.05	0.50±0.05	0.50±0.05	0.2±0.1
1	0603	1.6±0.1	0.8±0.1	0.8±0.1	0.3±0.2

## Multilayer Varistor, Low Capacitance Type [High speed signal lines]

### Features

- Multilayer monolithic ceramic construction for high speed signal lines
- Ideal for USB 2.0, IEEE1394, and HDMI high speed data busses
- Applicable to high-speed signal lines, such as interfaces (e.g. USB 2.0, IEEE1394, HDMI, and so on), due to our original material technology and multilayer technology
- Capacitance : 0.8 to 2.1 pF typ.

### Recommended Applications

Mobile phone	Antenna circuit, External IF
DSC, DVC	USB2.0, IEEE1394
PC, PDA	USB2.0, IEEE1394, LAN1000BASE
TV, DVD	USB2.0, IEEE1394, HDMI
Game console	Controller, External IF

### Ratings and Characteristics

Size	Part No.	Maximum allowable voltage DC (V)	Nominal varistor voltage at 1mA (V)	Capacitance (pF) at 1MHz	Maximum ESD IEC61000-4-2
0402	EZJZ0V80010	10	80	1 max. [0.8 typ.]	Contact discharge : 8kV
	EZJZ0V80015D	5	80	1.5±0.5	
	EZJZ0V500AA	5	50	3 max. [2.1 typ.]	
	EZJZ0V800AA	18	80	3 max. [2.1 typ.]	
	EZJZ0V171AA	18	170	3 max. [2.1 typ.]	
0603	EZJZ1V80010	10	80	1 max. [0.8 typ.]	
	EZJZ1V500AA	5	50	3 max. [2.1 typ.]	
	EZJZ1V800AA	18	80	3 max. [2.1 typ.]	
	EZJZ1V171AA	18	170	3 max. [2.1 typ.]	

- Operating Temperature Range: -40 to 85 °C
- \* Recommend soldering method : Reflow soldering

### Voltage vs. Current

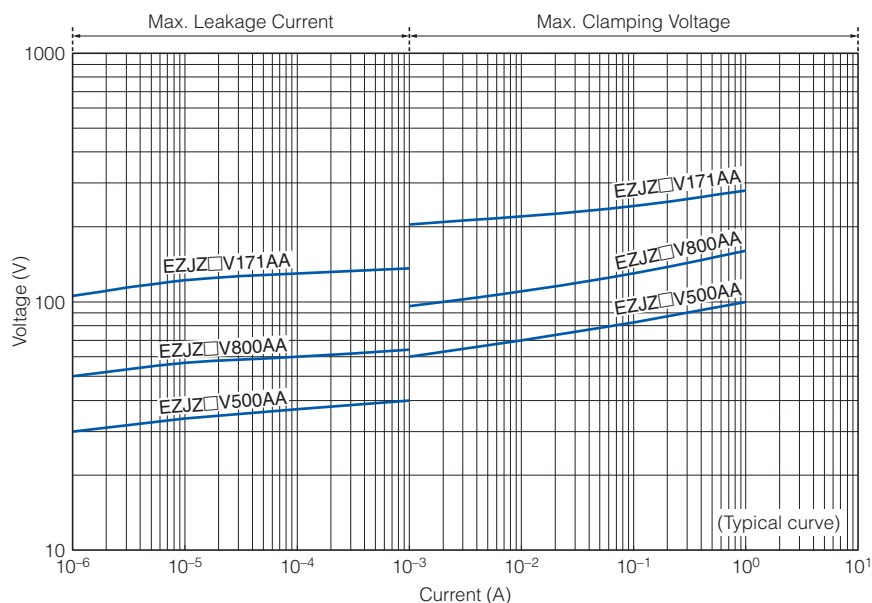

## Frequency vs. Capacitance

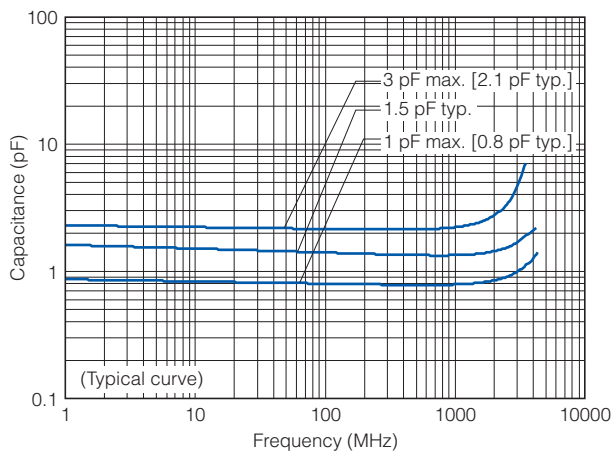

## Frequency vs. Impedance

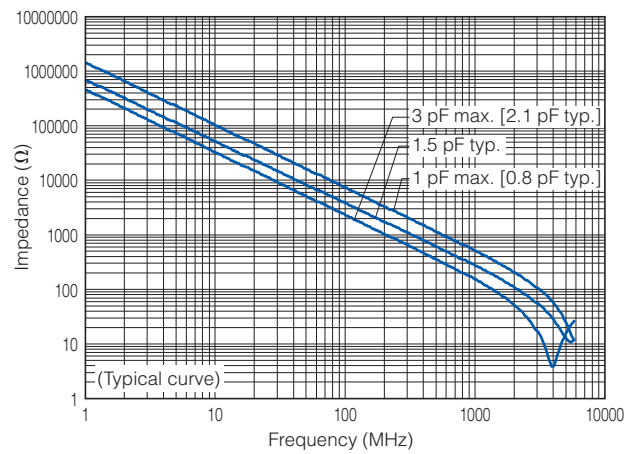

## Attenuation vs. Frequency

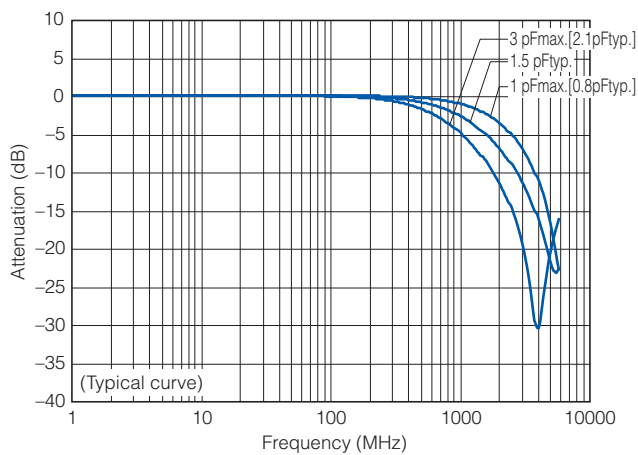

## Multilayer Varistor, Low Voltage Type (Standard Type) [DC voltage lines/Low speed signal lines]

### Features

Wide variety of products is available by adopting multilayer construction, which achieved wide range of usage, such as application to DC voltage lines and signal lines

- Circuit voltage

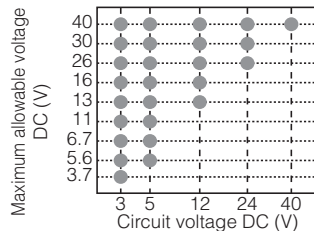

- Varistor voltage : 6.8 to 65 V [at 1 mA]
- Capacitance : 8.5 to 420 pF typ. [at 1 MHz]

### Recommended Applications

Mobile phone	SW, LCD, LED, Audio terminal, Battery pack, Memory card, External IF
DSC, DVC	SW, LCD, LED, USB
PC, PDA	SW, LCD, LED, USB
TV, DVD	Audio, Video terminal
Audio	Audio terminal, Microphone, Receiver
Game console	Controller, External IF

### Ratings and Characteristics

Size	Part No.	Maximum allowable voltage DC (V)	Nominal varistor voltage at 1mA (V)	Capacitance (pF)		Maximum peak current at 8/20μs, 2times (A)	Maximum ESD IEC61000-4-2
				at 1MHz	at 1kHz		
0201	EZJPZV6R8JA	3.7	6.8	220 max. [180 typ.]	175 typ.	5	Contact discharge 8 kV
	EZJPZV6R8GA	3.7	6.8	100 max. [ 85 typ.]	100 typ.	5	
	EZJPZV080GA	5.6	8	100 max. [ 85 typ.]	100 typ.	5	
	EZJPZV120GA	7.5	12	100 max. [ 85 typ.]	100 typ.	5	
	EZJPZV120DA	7.5	12	27 max. [ 22 typ.]	33 typ.	1	
	EZJPZV120RA	7.5	12	20 max. [ 15 typ.]	18 typ.	1	
	EZJPZV150RA	9	15	20 max. [ 15 typ.]	18 typ.	1	
	EZJPZV270RA	16	27	20 max. [ 15 typ.]	16.5 typ.	1	
0402	EZJPZV270BA	16	27	10 max. [8.5 typ.]	10 typ.	1	
	EZJP0V6R8MA	3.7	6.8	680 max. [420 typ.]	650 typ.	20	
	EZJP0V6R8GA	3.7	6.8	100 max. [ 85 typ.]	100 typ.	3	
	EZJP0V080MA	5.6	8	680 max. [420 typ.]	650 typ.	20	
	EZJP0V080KA	5.6	8	330 max. [290 typ.]	480 typ.	15	
	EZJP0V080GA	5.6	8	100 max. [ 65 typ.]	100 typ.	3	
	EZJP0V080DA	5.6	8	27 max. [ 22 typ.]	33 typ.	1	
	EZJZ0V120JA	6.7	12	220 max. [150 typ.]	175 typ.	10	
	EZJZ0V180HA	11	18	150 max. [120 typ.]	140 typ.	10	
	EZJZ0V220HA	13	22	150 max. [100 typ.]	116 typ.	10	
	EZJP0V270EA	16	27	47 max. [ 33 typ.]	37 typ.	4	
	EZJP0V270RA	16	27	20 max. [ 15 typ.]	16.5 typ.	1	
0603	EZJZ0V420WA	30	42	56 max. [ 40 typ.]	45 typ.	10	
	EZJZ0V650DA	40	65	27 max. [ 22 typ.]	33 typ.	5	
	EZJZ1V120KA	6.7	12	330 max. [250 typ.]	290 typ.	20	
	EZJZ1V180JA	11	18	220 max. [180 typ.]	210 typ.	20	
	EZJZ1V220JA	13	22	220 max. [160 typ.]	185 typ.	20	
	EZJZ1V270GA	16	27	100 max. [ 85 typ.]	100 typ.	20	
	EZJZ1V270EA	16	27	47 max. [ 33 typ.]	37 typ.	20	
	EZJZ1V270RA	16	27	20 max. [ 15 typ.]	16.5 typ.	3	
	EZJZ1V330GA	26	33	100 max. [ 85 typ.]	100 typ.	20	
	EZJZ1V420FA	30	42	68 max. [ 55 typ.]	63 typ.	15	
	EZJZ1V650DA	40	65	27 max. [ 22 typ.]	33 typ.	5	

- Operating Temperature Range: -40 to 85 °C \* Recommend soldering method : Reflow soldering

Maximum Allowable Voltage	Maximum DC Voltage that can be applied continuously within the operating temperature range
Varistor Voltage	Varistor starting voltage between terminals at DC 1 mA, also known as Breakdown voltage
Maximum Peak Current	Maximum current that can be withstood under the standard pulse 8/20 μs, 2 times based
Maximum ESD	Maximum voltage that can be withstood under ESD based on IEC61000-4-2, 10 times (5 times of each positive-negative polarity)

## Voltage vs. Current

### ● EZJP Series

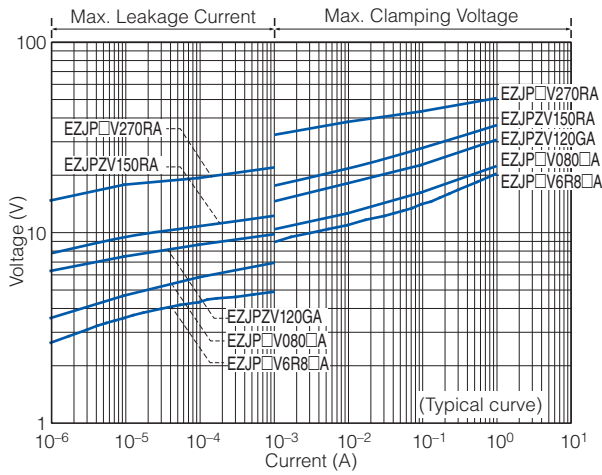

### ● EZJZ Series

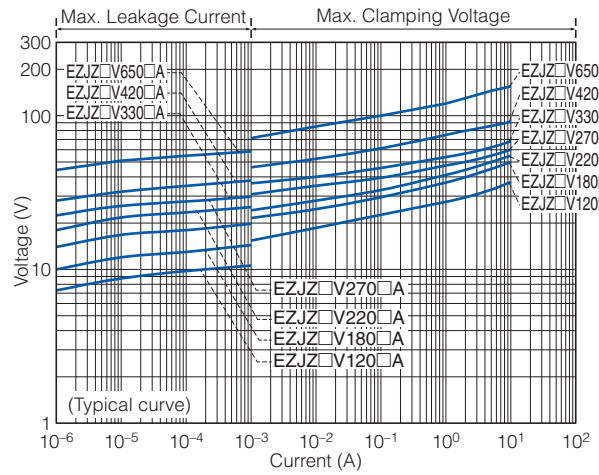

## Frequency vs. Capacitance

### ● EZJP Series

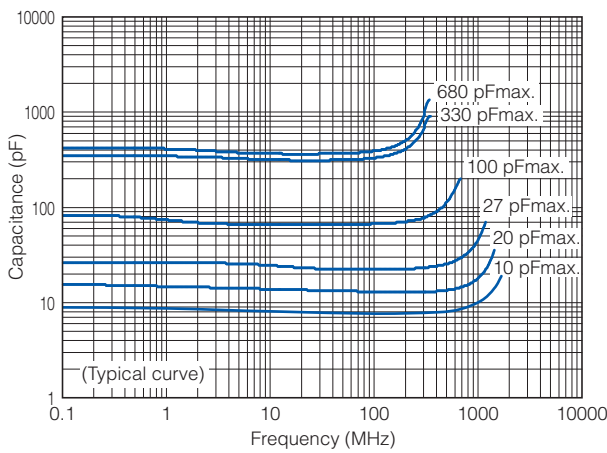

### ● EZJZ Series

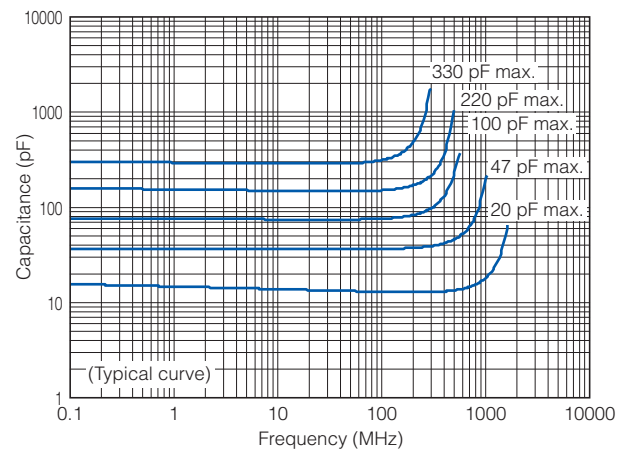

## Attenuation vs. Frequency

### ● EZJP Series

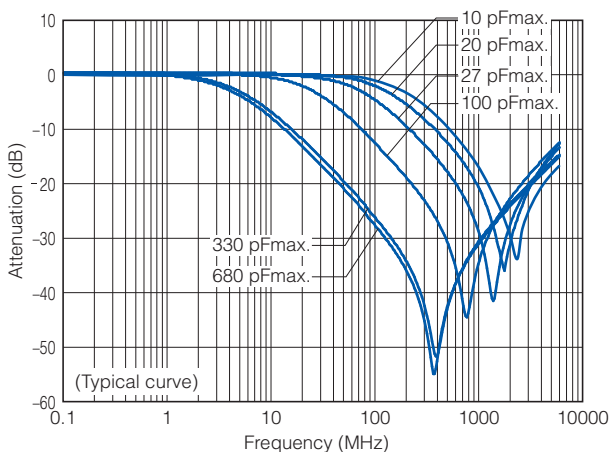

### ● EZJZ Series

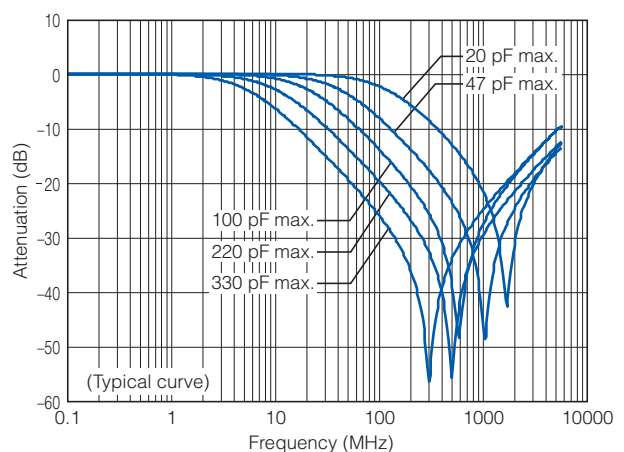

## Varistor Characteristics and Equivalent Circuit

A Multilayer Varistor does not have an electrical polarity like zener diodes and is equivalent to total 3 pcs. of 2 zener diodes and 1 capacitor.

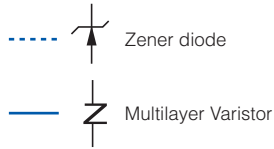
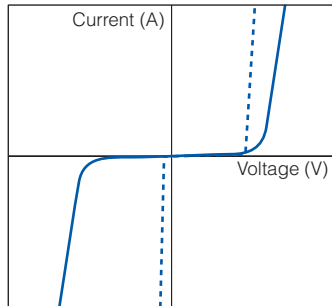

[Equivalent Circuit]

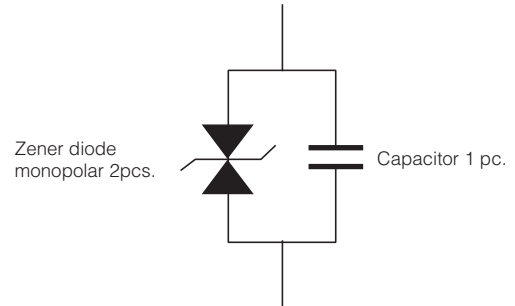

## ESD Suppressive Effects

Typical effects of ESD suppression

Test conditions: IEC61000-4-2\* Level 4 Contact discharge, 8 kV

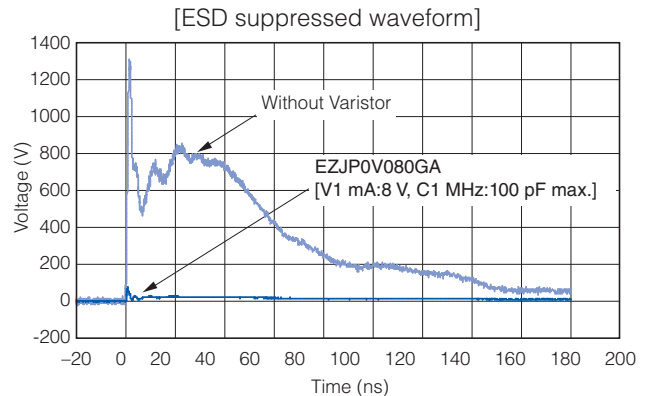
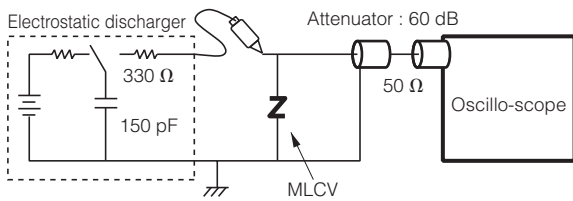

\* IEC61000-4-2 ... International Standard of the ESD testing method (HBM) for electronic equipment ability to withstand ESD generated from a human body. It sets 4 levels of severity

Severity	Level 1	Level 2	Level 3	Level 4
Contact discharge	2 kV	4 kV	6 kV	8 kV
Air discharge	2 kV	4 kV	8 kV	15 kV

## Replacement of Zener diode

Replacing "Zener diode and Capacitor" with Multilayer Varistor saves both the mounting area and number of components used.

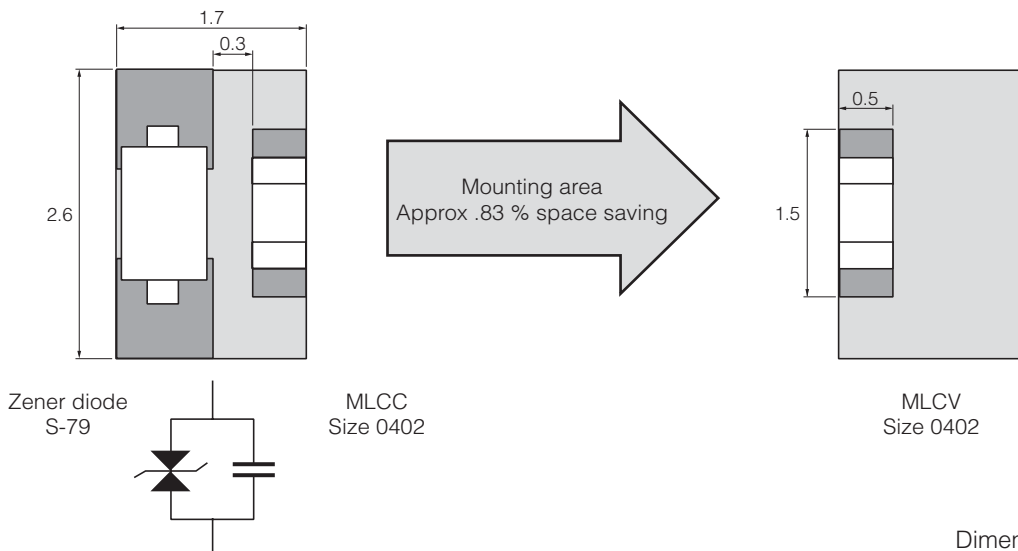

## Recommended Applications

Applications	Series	Circuit	Series		
			DC	1k	1M
Mobile phones, DSC, PC, PDA, HDD TV (PDP, LC etc.), DVD, DVC, Game consoles, Audio equipment	Series EZJZ, P	Ultra low capacitance (Cap. : 3 pF or less)	[Bar chart showing high performance at high frequencies]		
		Low capacitance (Cap. : 20 to 680 pF)	[Bar chart showing performance at lower frequencies]		
PWR, Photoelectric sensors, SSR, Motors, Pressure sensors, Proximity switches	Series EZJS	High capacitance (Cap. : 1800 to 22000 pF)	[Bar chart showing performance at low frequencies]		

## Applications

### ● Mobile Phone

· Audio lines

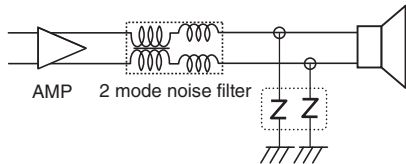

· LED

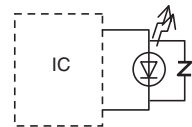

· SW/Keyboard

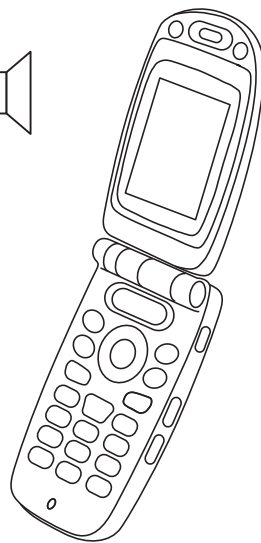
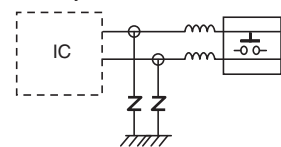

· LCD/Camera lines

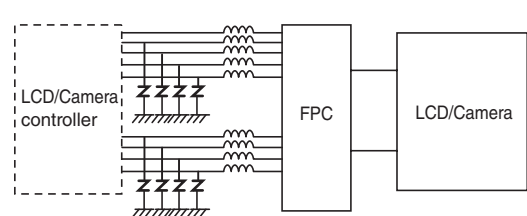

· I/O data lines

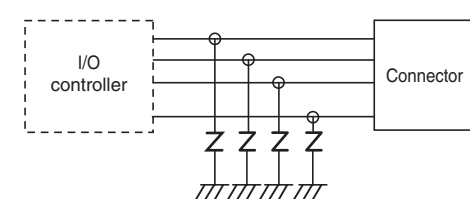

### ● USB1.1/2.0 lines

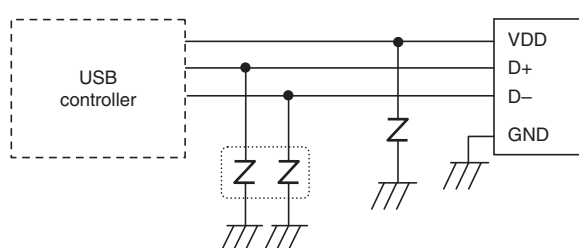

### ● IEEE1394 lines

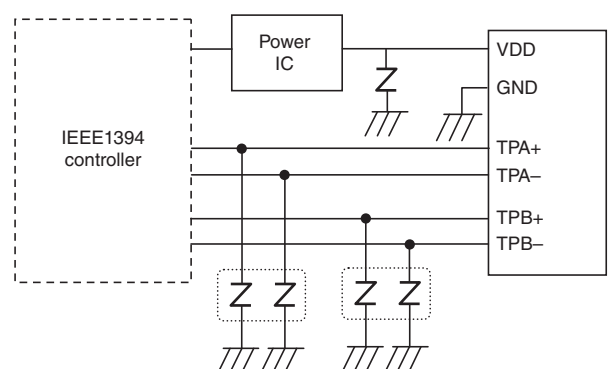

### ● HDMI lines

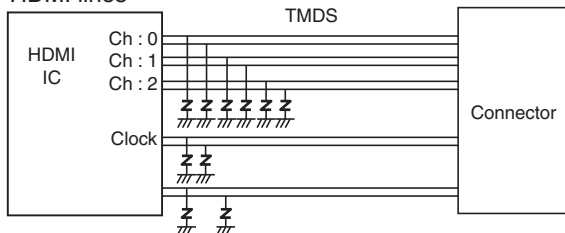

## Performance and Testing Methods

Characteristics	Specifications	Testing Method															
Standard test conditions		Electrical characteristics shall be measured under the following conditions. Temp. : 5 to 35 °C, Relative humidity : 85 % or less															
Varistor voltage	To meet the specified value.	The Varistor voltage is the voltage ( $V_c$ , or $V_{cMA}$ ) between both end terminals of a Varistor when specified current ( $C_{mA}$ ) is applied to it. The measurement shall be made as quickly as possible to avoid heating effects.															
Maximum allowable voltage	To meet the specified value.	The maximum DC voltage that can be applied continuously to a varistor															
Capacitance	To meet the specified value.	Capacitance shall be measured at the specified frequency, bias voltage 0 V, and measuring voltage 0.2 to 2 Vrms.															
Maximum peak current	To meet the specified value.	The maximum current measured (Varistor voltage tolerance is within $\pm 10\%$ ) when a standard impulse current of 8/20 $\mu$ seconds is applied twice with an interval of 5 minutes.															
Maximum ESD	To meet the specified value.	The maximum ESD measured (while the varistor voltage is within $\pm 30\%$ of its nominal value) when exposed to ESD 10 times (five times for each positive-negative polarity) based on IEC61000-4-2.															
Solder ability	To meet the specified value.	The part shall be immersed into a soldering bath under the conditions below. Solder: H63A Soldering flux : Ethanol solution of rosin (Concentration approx. 25 wt%) Soldering temp. : 230 $\pm$ 5 °C Period : 4 $\pm$ 1 s Soldering position: Immerse both terminal electrodes until they are completely into the soldering bath.															
Resistance to soldering heat	$\Delta V_c / V_c$ : within $\pm 10\%$	After the immersion, leave the part for 24 $\pm$ 2 hours under the standard condition, then evaluate its characteristics. Soldering conditions are specified below: Soldering conditions : 270 °C, 3 s / 260 °C, 10 s Soldering position : Immerse both terminal electrodes until they are completely into the soldering bath.															
Temperature cycling	$\Delta V_c / V_c$ : within $\pm 10\%$	After repeating the cycles stated below for specified number of times, leave the part for 24 $\pm$ 2 hours, then evaluate its characteristics.  Cycle : 5 cycles <table border="1" style="margin-left: auto; margin-right: auto;"> <thead> <tr> <th>Step</th> <th>Temperature</th> <th>Period</th> </tr> </thead> <tbody> <tr> <td>1</td> <td>Max. Operating Temp.</td> <td>30<math>\pm</math>3 min</td> </tr> <tr> <td>2</td> <td>Ordinary temp.</td> <td>3 min max.</td> </tr> <tr> <td>3</td> <td>Min. Operating Temp.</td> <td>30<math>\pm</math>3 min</td> </tr> <tr> <td>4</td> <td>Ordinary temp.</td> <td>3 min max.</td> </tr> </tbody> </table>	Step	Temperature	Period	1	Max. Operating Temp.	30 $\pm$ 3 min	2	Ordinary temp.	3 min max.	3	Min. Operating Temp.	30 $\pm$ 3 min	4	Ordinary temp.	3 min max.
Step	Temperature	Period															
1	Max. Operating Temp.	30 $\pm$ 3 min															
2	Ordinary temp.	3 min max.															
3	Min. Operating Temp.	30 $\pm$ 3 min															
4	Ordinary temp.	3 min max.															
Biased Humidity	$\Delta V_c / V_c$ : within $\pm 10\%$	After conducting the test under the conditions specified below, leave the part 24 $\pm$ 2 hours, then evaluate its characteristics. Temp. : 40 $\pm$ 2 °C Humidity : 90 to 95 %RH Applied voltage : Maximum allowable voltage (Individually specified) Period : 500+24 / 0 h															
High temperature exposure (dry heat)	$\Delta V_c / V_c$ : within $\pm 10\%$	After conducting the test under the conditions specified below, leave the part 24 $\pm$ 2 hours, then evaluate its characteristics. Temp. : Maximum operating temperature $\pm 3$ °C (Individually specified) Applied voltage : Maximum allowable voltage (Individually specified) Period : 500+24 / 0h															