

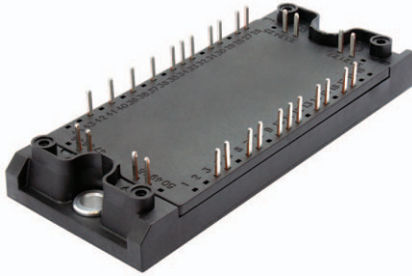

IGBT Fourpack Module, 50 A

ECONO2 4PACK

FEATURES

- Square RBSOA
- HEXFRED® low Q_{rr} , low switching energy
- Positive $V_{CE(on)}$ temperature coefficient
- Copper baseplate
- Low stray inductance design
- Designed and qualified for industrial market
- UL approved file E78996 
- Material categorization: for definitions of compliance please see www.vishay.com/doc?99912

**RoHS
COMPLIANT**

PRODUCT SUMMARY	
V_{CES}	1200 V
I_C at $T_C = 66\text{ °C}$	50 A
$V_{CE(on)}$ (typical)	3.49 V
Speed	8 kHz to 30 kHz
Package	ECONO2
Circuit	4 PACK

BENEFITS

- Benchmark efficiency for SMPS appreciation in particular HF welding
- Rugged transient performance
- Low EMI, requires less snubbing
- Direct mounting to heatsink space saving
- PCB solderable terminals
- Low junction to case thermal resistance

ABSOLUTE MAXIMUM RATINGS				
PARAMETER	SYMBOL	TEST CONDITIONS	MAX.	UNITS
Collector to emitter voltage	V_{CES}		1200	V
Continuous collector current	I_C	$T_C = 25\text{ °C}$	66	A
		$T_C = 80\text{ °C}$	44	
Pulsed collector current See fig. C.T.5	I_{CM}		150	
Clamped inductive load current	I_{LM}		150	
Diode continuous forward current	I_F	$T_C = 25\text{ °C}$	40	
		$T_C = 80\text{ °C}$	25	
Diode maximum forward current	I_{FM}		150	
Gate to emitter voltage	V_{GE}		± 20	V
Maximum power dissipation (IGBT)	P_D	$T_C = 25\text{ °C}$	330	W
		$T_C = 80\text{ °C}$	180	
Maximum operating junction temperature	T_J		150	°C
Storage temperature range	T_{Stg}		-40 to +125	
Isolation voltage	V_{ISOL}		AC 2500 (min)	V



ELECTRICAL SPECIFICATIONS ($T_J = 25\text{ }^\circ\text{C}$ unless otherwise specified)						
PARAMETER	SYMBOL	TEST CONDITIONS	MIN.	TYP.	MAX.	UNITS
Collector to emitter breakdown voltage	$BV_{(CES)}$	$V_{GE} = 0\text{ V}, I_C = 500\text{ }\mu\text{A}$	1200	-	-	V
Collector to emitter voltage	$V_{CE(ON)}$	$I_C = 50\text{ A}, V_{GE} = 15\text{ V}$	-	3.49	3.9	
		$I_C = 75\text{ A}, V_{GE} = 15\text{ V}$	-	4.15	4.5	
		$I_C = 50\text{ A}, V_{GE} = 15\text{ V}, T_J = 125\text{ }^\circ\text{C}$	-	4.16	4.5	
		$I_C = 75\text{ A}, V_{GE} = 15\text{ V}, T_J = 125\text{ }^\circ\text{C}$	-	4.97	5.4	
Gate threshold voltage	$V_{GE(th)}$	$V_{CE} = V_{GE}, I_C = 250\text{ }\mu\text{A}$	4.0	4.9	6.0	
Threshold voltage temperature coefficient	$\Delta V_{GE(th)}/\Delta T_J$	$V_{CE} = V_{GE}, I_C = 1\text{ mA}$ (25 °C to 125 °C)	-	-10	-	mV/°C
Zero gate voltage collector current	I_{CES}	$V_{GE} = 0\text{ V}, V_{CE} = 1200\text{ V}$	-	11	250	μA
		$V_{GE} = 0\text{ V}, V_{CE} = 1200\text{ V}, T_J = 125\text{ }^\circ\text{C}$	-	600	1000	
Diode forward voltage drop	V_{FM}	$I_F = 50\text{ A}$	-	3.30	4.5	V
		$I_F = 75\text{ A}$	-	3.90	5.0	
		$I_F = 50\text{ A}, T_J = 125\text{ }^\circ\text{C}$	-	3.6	4.8	
		$I_F = 75\text{ A}, T_J = 125\text{ }^\circ\text{C}$	-	4.37	5.5	
Gate to emitter leakage current	I_{GES}	$V_{GE} = \pm 20\text{ V}$	-	-	± 200	nA

SWITCHING CHARACTERISTICS ($T_J = 25\text{ }^\circ\text{C}$ unless otherwise noted)						
PARAMETER	SYMBOL	TEST CONDITIONS	MIN.	TYP.	MAX.	UNITS
Total gate charge (turn-on)	Q_G	$I_C = 50\text{ A}$ $V_{CC} = 600\text{ V}$ $V_{GE} = 15\text{ V}$	-	400	-	nC
Gate to emitter charge (turn-on)	Q_{GE}		-	43	-	
Gate to collector charge (turn-on)	Q_{GC}		-	187	-	
Turn-on switching loss	E_{on}	$I_C = 50\text{ A}, V_{CC} = 600\text{ V}$ $V_{GE} = 15\text{ V}, R_G = 4.7\text{ }\Omega, L = 500\text{ }\mu\text{H}$ $T_J = 25\text{ }^\circ\text{C}$ (1)	-	0.93	-	mJ
Turn-off switching loss	E_{off}		-	1.20	-	
Total switching loss	E_{tot}		-	2.13	-	
Turn-on switching loss	E_{on}	$I_C = 50\text{ A}, V_{CC} = 600\text{ V}$ $V_{GE} = 15\text{ V}, R_G = 4.7\text{ }\Omega, L = 500\text{ }\mu\text{H}$ $T_J = 125\text{ }^\circ\text{C}$ (1)	-	1.68	-	mJ
Turn-off switching loss	E_{off}		-	1.77	-	
Total switching loss	E_{tot}		-	3.46	-	
Turn-on delay time	$t_{d(on)}$	$I_C = 50\text{ A}, V_{CC} = 600\text{ V}$ $V_{GE} = 15\text{ V}, R_G = 4.7\text{ }\Omega, L = 500\text{ }\mu\text{H}$ $T_J = 125\text{ }^\circ\text{C}$	-	128	-	ns
Rise time	t_r		-	56	-	
Turn-off delay time	$t_{d(off)}$		-	292	-	
Fall time	t_f		-	134	-	
Reverse bias safe operating area	RBSOA	$T_J = 150\text{ }^\circ\text{C}, I_C = 150\text{ A}$ $R_G = 10\text{ }\Omega, V_{GE} = 15\text{ V to } 0\text{ V}$	Fullsquare			
Short circuit safe operating area	SCSOA	$T_J = 150\text{ }^\circ\text{C}$ $V_{CC} = 900\text{ V}, V_P = 1200\text{ V}$ $R_G = 10\text{ }\Omega, V_{GE} = 15\text{ V to } 0\text{ V}$	10	-	-	μs
Diode peak reverse recovery current	I_{rr}	$T_J = 25\text{ }^\circ\text{C}$	-	1.3	2.3	A
		$T_J = 125\text{ }^\circ\text{C}$	-	2.0	3	
Diode reverse recovery time	t_{rr}	$T_J = 25\text{ }^\circ\text{C}$	-	0.453	0.49	μs
		$T_J = 125\text{ }^\circ\text{C}$	-	0.74	0.82	
Total reverse recovery charge	Q_{rr}	$T_J = 25\text{ }^\circ\text{C}$	-	0.12	0.3	μC
		$T_J = 125\text{ }^\circ\text{C}$	-	0.4	1.5	

Note

(1) Energy losses include "tail" and diode reverse recovery



THERMAL AND MECHANICAL SPECIFICATIONS					
PARAMETER	SYMBOL	MIN.	TYP.	MAX.	UNITS
Junction to case IGBT	R_{thJC} (IGBT)	-	-	0.38	°C/W
Junction to case DIODE	R_{thJC} (DIODE)	-	-	1.00	
Case to sink, flat, greased surface	R_{thCS} (MODULE)	-	0.05	-	
Mounting torque (M5)		2.7	-	3.3	Nm
Weight		-	170	-	g

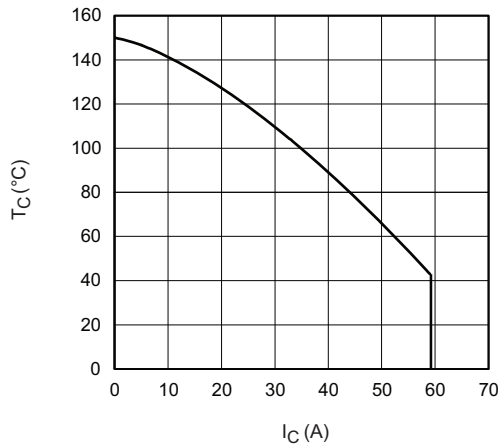

Fig. 1 - Maximum DC Collector Current vs. Case Temperature

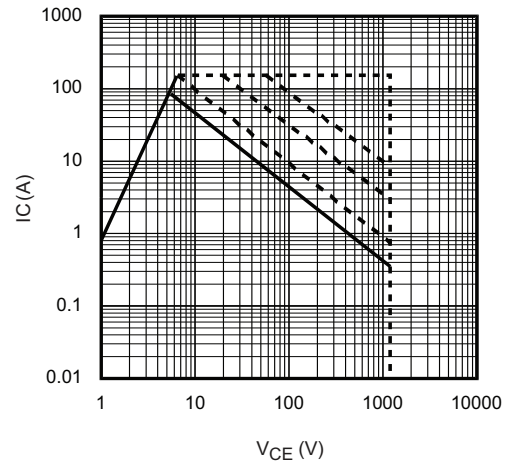

Fig. 3 - Forward SOA
 $T_C = 25\text{ }^\circ\text{C}$; $T_J \leq 150\text{ }^\circ\text{C}$

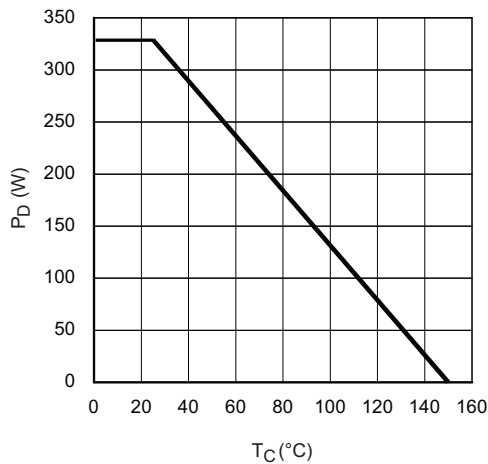

Fig. 2 - Power Dissipation vs. Case Temperature

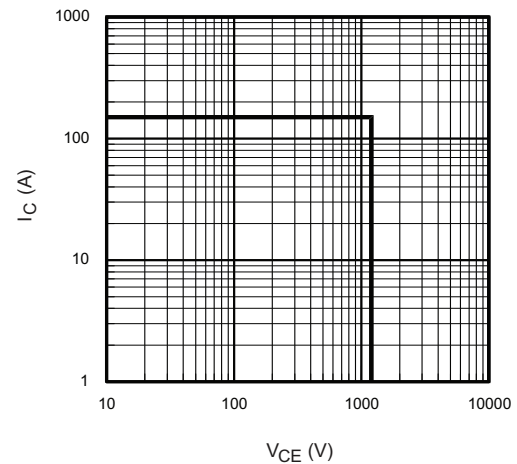
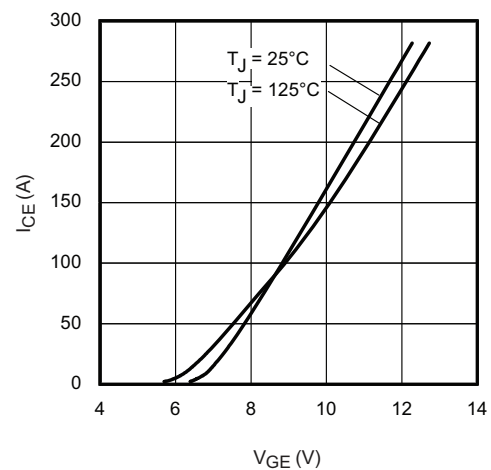
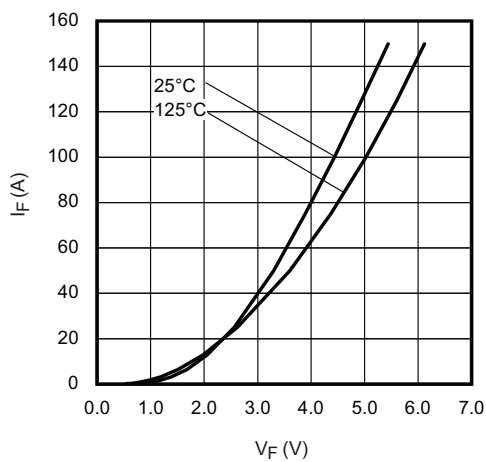
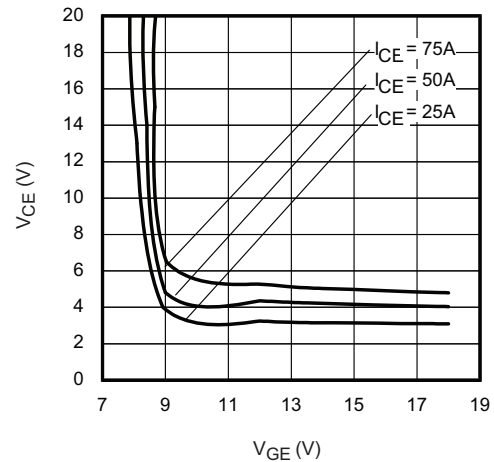
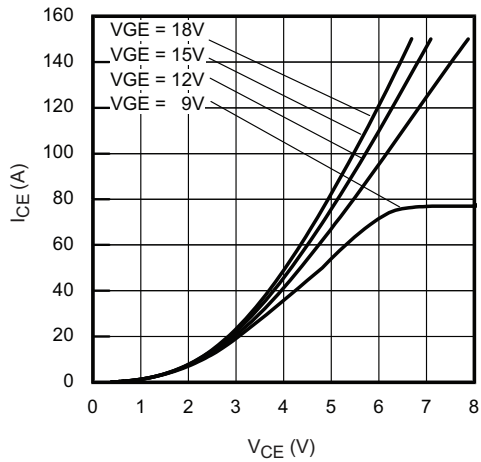
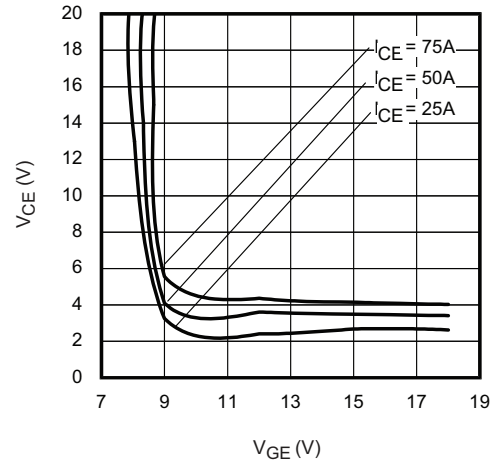
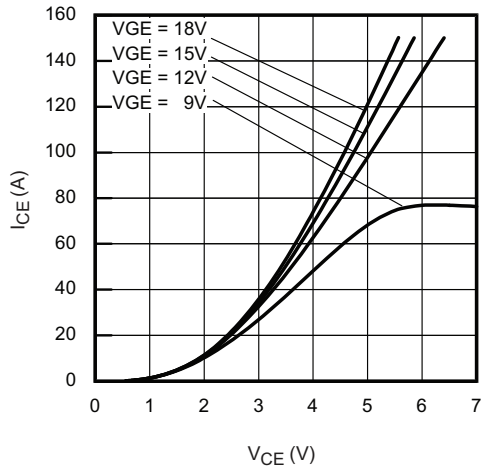

Fig. 4 - Reverse Bias SOA
 $T_J = 150\text{ }^\circ\text{C}$; $V_{GE} = 15\text{ V}$



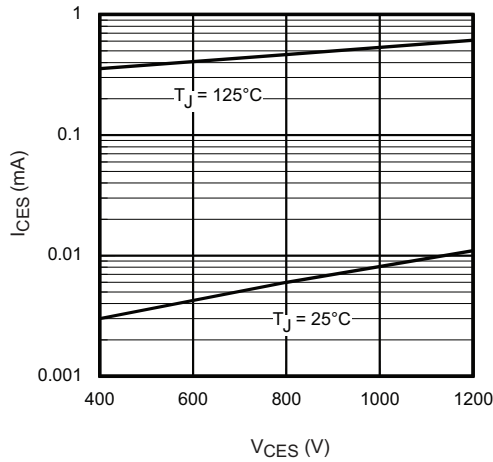

Fig. 11 - Typical Zero Gate Voltage Collector Current

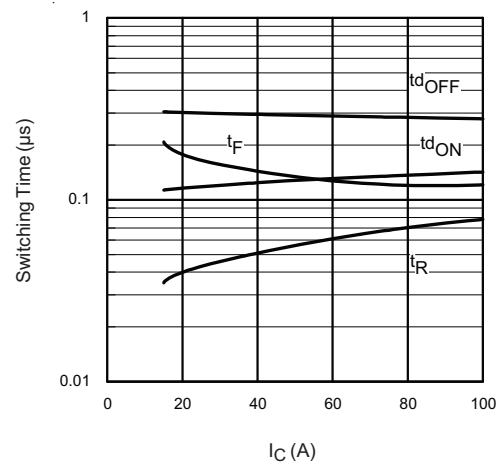

Fig. 14 - Typical Switching Time vs. I_C
 $T_J = 125^\circ\text{C}$; $L = 200\ \mu\text{H}$; $V_{CE} = 600\ \text{V}$; $R_G = 5\ \Omega$; $V_{GE} = 15\ \text{V}$

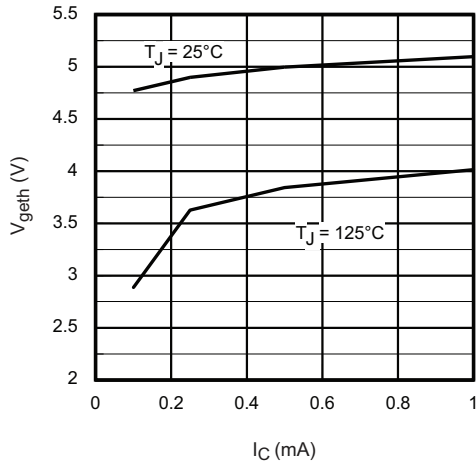

Fig. 12 - Typical Threshold Voltage

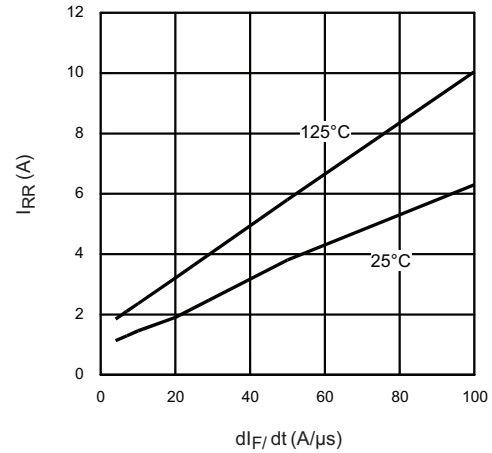

Fig. 15 - Typical Diode I_{REC} vs. df/dt
 $V_{CC} = 600\ \text{V}$; $I_F = 50\ \text{A}$

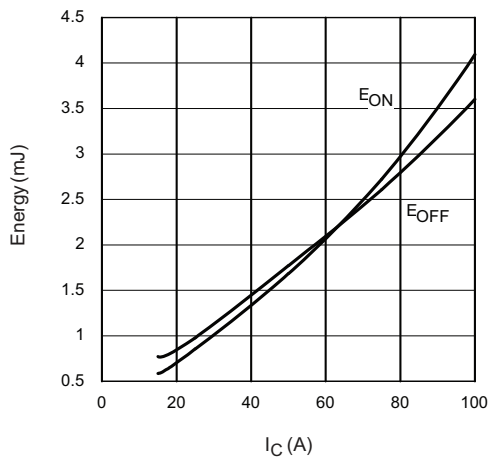

Fig. 13 - Typical Energy Loss vs. I_C
 $T_J = 125^\circ\text{C}$; $L = 200\ \mu\text{H}$; $V_{CE} = 600\ \text{V}$; $R_G = 5\ \Omega$; $V_{GE} = 15\ \text{V}$

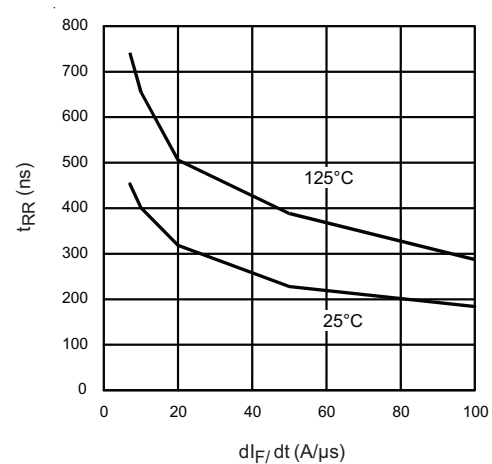

Fig. 16 - Typical Diode t_{rr} vs. df/dt
 $V_{CC} = 600\ \text{V}$; $I_F = 50\ \text{A}$

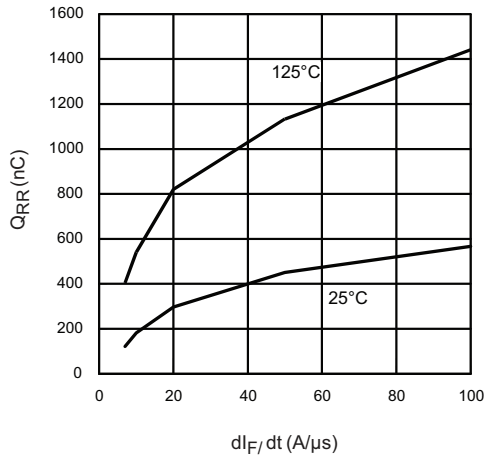

Fig. 17 - Typical Diode Q_{rr} vs. dI_F/dt
 $V_{CC} = 600\text{ V}$; $I_F = 50\text{ A}$

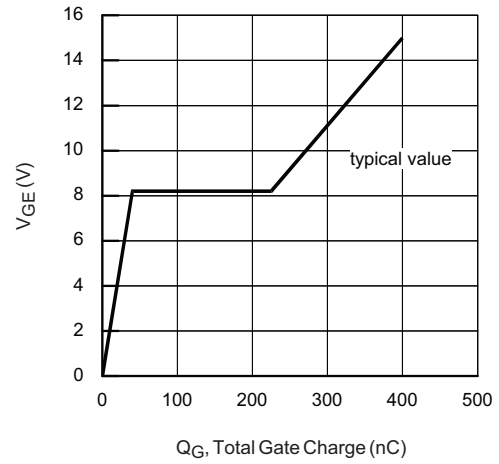

Fig. 18 - Typical Gate Charge vs. V_{GE}
 $I_{CE} = 5.0\text{ A}$; $L = 600\text{ μH}$

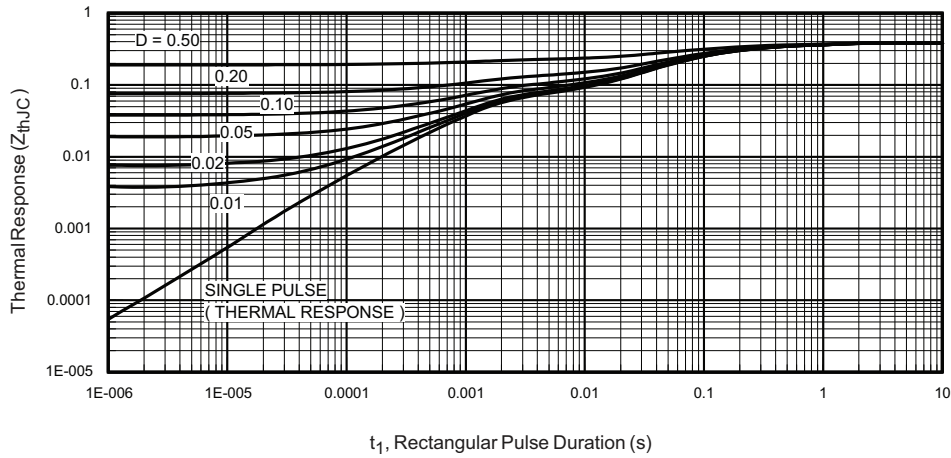

Fig. 19 - Maximum Transient Thermal Impedance, Junction to Case (IGBT)

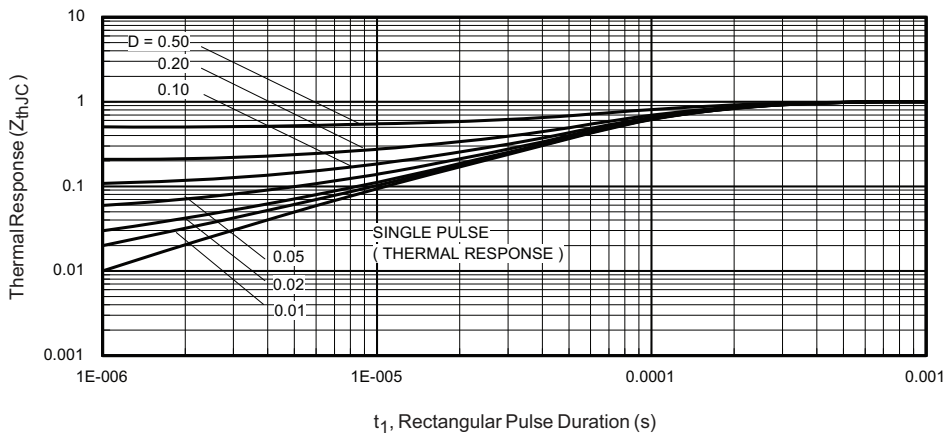

Fig. 20 - Maximum Transient Thermal Impedance, Junction to Case (DIODE)

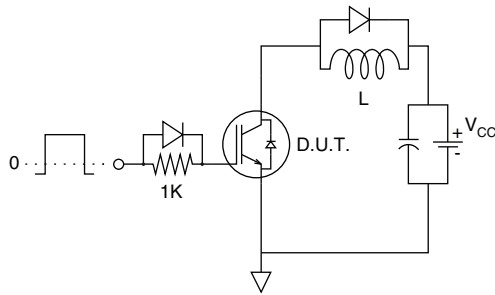

Fig. 21 - Gate Charge Circuit (Turn-Off)

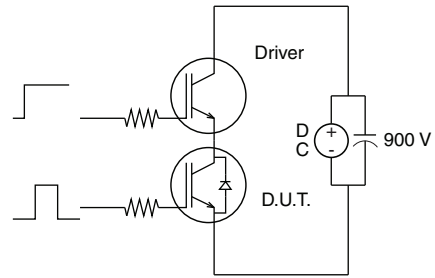

Fig. 23 - S.C. SOA Circuit

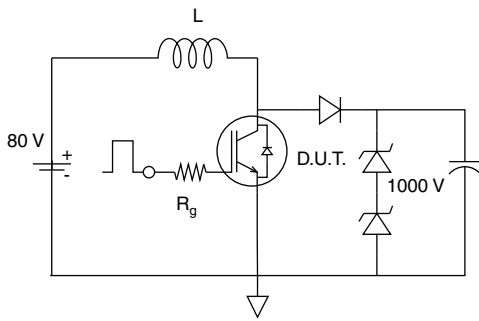

Fig. 22 - RBSOA Circuit

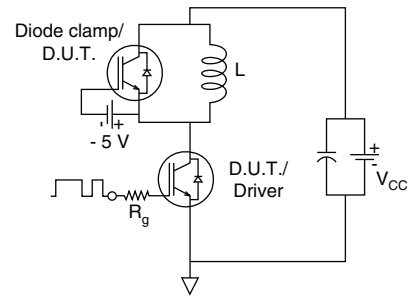

Fig. 24 - Switching Loss Circuit

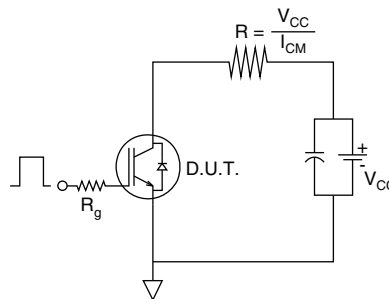

Fig. 25 - Resistive Load Circuit

ORDERING INFORMATION TABLE

Device code	VS-	G	B	50	Y	F	120	N
	①	②	③	④	⑤	⑥	⑦	⑧

- 1** - Vishay Semiconductors product
- 2** - Insulated gate bipolar transistor (IGBT)
- 3** - B = IGBT Generation 5 NPT
- 4** - Current rating (50 = 50 A)
- 5** - Circuit configuration (Y = Fourpack)
- 6** - Package indicator (F = ECONO2)
- 7** - Voltage rating (120 = 1200 V)
- 8** - Speed/type (N = Ultrafast with reduced diode, speed 8 kHz to 60 kHz)

CIRCUIT CONFIGURATION

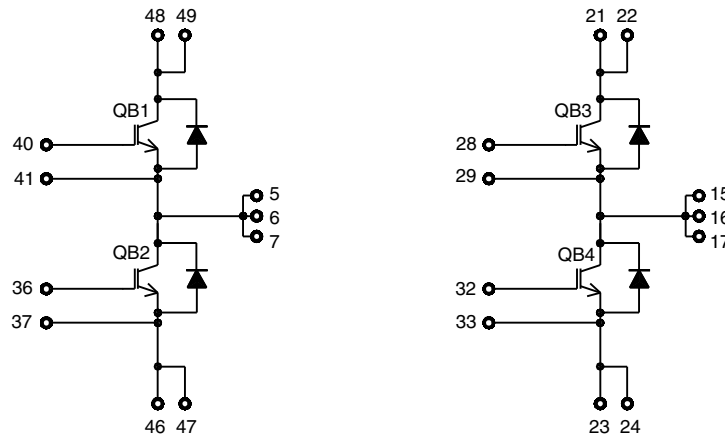

LINKS TO RELATED DOCUMENTS

Dimensions	www.vishay.com/doc?95539
------------	--



ECONO2 4PACK N Series

DIMENSIONS in millimeters

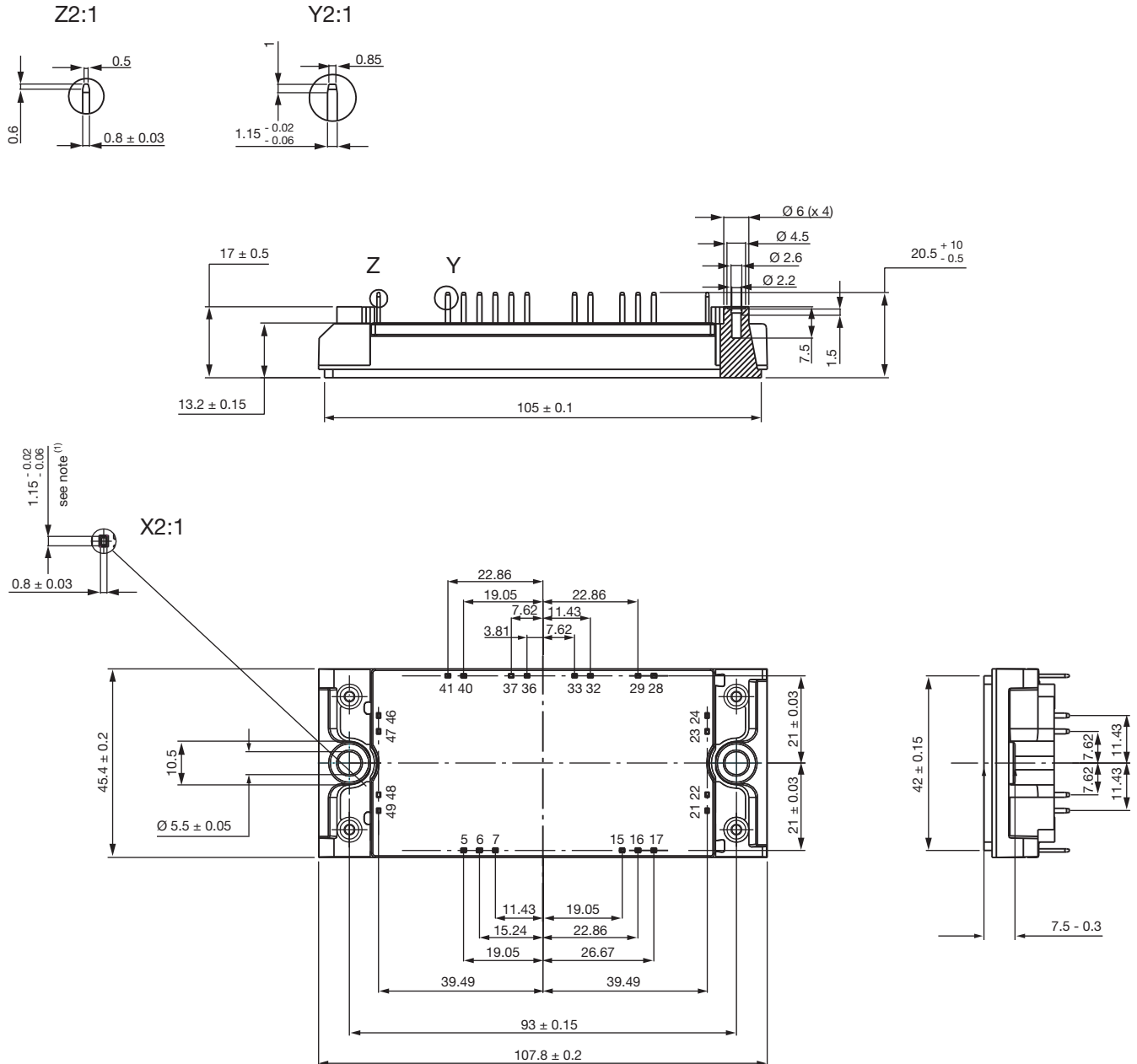



Disclaimer

ALL PRODUCT, PRODUCT SPECIFICATIONS AND DATA ARE SUBJECT TO CHANGE WITHOUT NOTICE TO IMPROVE RELIABILITY, FUNCTION OR DESIGN OR OTHERWISE.

Vishay Intertechnology, Inc., its affiliates, agents, and employees, and all persons acting on its or their behalf (collectively, "Vishay"), disclaim any and all liability for any errors, inaccuracies or incompleteness contained in any datasheet or in any other disclosure relating to any product.

Vishay makes no warranty, representation or guarantee regarding the suitability of the products for any particular purpose or the continuing production of any product. To the maximum extent permitted by applicable law, Vishay disclaims (i) any and all liability arising out of the application or use of any product, (ii) any and all liability, including without limitation special, consequential or incidental damages, and (iii) any and all implied warranties, including warranties of fitness for particular purpose, non-infringement and merchantability.

Statements regarding the suitability of products for certain types of applications are based on Vishay's knowledge of typical requirements that are often placed on Vishay products in generic applications. Such statements are not binding statements about the suitability of products for a particular application. It is the customer's responsibility to validate that a particular product with the properties described in the product specification is suitable for use in a particular application. Parameters provided in datasheets and / or specifications may vary in different applications and performance may vary over time. All operating parameters, including typical parameters, must be validated for each customer application by the customer's technical experts. Product specifications do not expand or otherwise modify Vishay's terms and conditions of purchase, including but not limited to the warranty expressed therein.

Except as expressly indicated in writing, Vishay products are not designed for use in medical, life-saving, or life-sustaining applications or for any other application in which the failure of the Vishay product could result in personal injury or death. Customers using or selling Vishay products not expressly indicated for use in such applications do so at their own risk. Please contact authorized Vishay personnel to obtain written terms and conditions regarding products designed for such applications.

No license, express or implied, by estoppel or otherwise, to any intellectual property rights is granted by this document or by any conduct of Vishay. Product names and markings noted herein may be trademarks of their respective owners.