

Phase Control Thyristors (Hockey PUK Version), 650 A



TO-200AB (E-PUK)

PRODUCT SUMMARY	
Package	TO-200AB (E-PUK)
Diode variation	Single SCR
$I_{T(AV)}$	650 A
V_{DRM}/V_{RRM}	400 V to 2000 V
V_{TM}	2.18 V
I_{GT}	100 mA
T_J	-40 °C to 125 °C

FEATURES

- Center amplifying gate
- Metal case with ceramic insulator
- International standard case TO-200AB (E-PUK)
- Designed and qualified for industrial level
- Material categorization: For definitions of compliance please see www.vishay.com/doc?99912

**RoHS
COMPLIANT**
TYPICAL APPLICATIONS

- DC motor controls
- Controlled DC power supplies
- AC controllers

MAJOR RATINGS AND CHARACTERISTICS			
PARAMETER	TEST CONDITIONS	VALUES	UNITS
$I_{T(AV)}$		650	A
	T_{hs}	55	°C
$I_{T(RMS)}$		1290	A
	T_{hs}	25	°C
I_{TSM}	50 Hz	8000	A
	60 Hz	8380	
i^2t	50 Hz	320	kA ² s
	60 Hz	292	
V_{DRM}/V_{RRM}		400 to 2000	V
t_q	Typical	100	µs
T_J		-40 to 125	°C

ELECTRICAL SPECIFICATIONS

VOLTAGE RATINGS				
TYPE NUMBER	VOLTAGE CODE	V_{DRM}/V_{RRM} , MAXIMUM REPETITIVE PEAK AND OFF-STATE VOLTAGE V	V_{RSM} , MAXIMUM NON-REPETITIVE PEAK VOLTAGE V	I_{DRM}/I_{RRM} MAXIMUM AT $T_J = T_J$ MAXIMUM mA
VS-ST300C..C	04	400	500	50
	08	800	900	
	12	1200	1300	
	16	1600	1700	
	18	1800	1900	
	20	2000	2100	



ABSOLUTE MAXIMUM RATINGS					
PARAMETER	SYMBOL	TEST CONDITIONS		VALUES	UNITS
Maximum average on-state current at heatsink temperature	$I_{T(AV)}$	180° conduction, half sine wave double side (single side) cooled		650 (320)	A
				55 (75)	°C
Maximum RMS on-state current	$I_{T(RMS)}$	DC at 25 °C heatsink temperature double side cooled		1290	A
Maximum peak, one-cycle non-repetitive surge current	I_{TSM}	t = 10 ms	No voltage reapplied	8000	
		t = 8.3 ms	No voltage reapplied	8380	
		t = 10 ms	100 % V_{RRM} reapplied	6730	
		t = 8.3 ms	100 % V_{RRM} reapplied	7040	
Maximum I^2t for fusing	I^2t	t = 10 ms	No voltage reapplied	320	kA ² s
		t = 8.3 ms	No voltage reapplied	292	
		t = 10 ms	100 % V_{RRM} reapplied	226	
		t = 8.3 ms	100 % V_{RRM} reapplied	207	
Maximum $I^2\sqrt{t}$ for fusing	$I^2\sqrt{t}$	t = 0.1 to 10 ms, no voltage reapplied		3200	kA ² √s
Low level value of threshold voltage	$V_{T(TO)1}$	(16.7 % $\times \pi \times I_{T(AV)} < I < \pi \times I_{T(AV)}$), $T_J = T_J$ maximum		0.97	V
High level value of threshold voltage	$V_{T(TO)2}$	(I > $\pi \times I_{T(AV)}$), $T_J = T_J$ maximum		0.98	
Low level value of on-state slope resistance	r_{t1}	(16.7 % $\times \pi \times I_{T(AV)} < I < \pi \times I_{T(AV)}$), $T_J = T_J$ maximum		0.74	mΩ
High level value of on-state slope resistance	r_{t2}	(I > $\pi \times I_{T(AV)}$), $T_J = T_J$ maximum		0.73	
Maximum on-state voltage	V_{TM}	$I_{pk} = 1635$ A, $T_J = T_J$ maximum, $t_p = 10$ ms sine pulse		2.18	V
Maximum holding current	I_H	$T_J = 25$ °C, anode supply 12 V resistive load		600	mA
Typical latching current	I_L			1000	

SWITCHING					
PARAMETER	SYMBOL	TEST CONDITIONS		VALUES	UNITS
Maximum non-repetitive rate of rise of turned-on current	di/dt	Gate drive 20 V, 20 Ω, $t_r \leq 1$ μs $T_J = T_J$ maximum, anode voltage ≤ 80 % V_{DRM}		1000	A/μs
Typical delay time	t_d	Gate current 1 A, $di_g/dt = 1$ A/μs $V_d = 0.67$ % V_{DRM} , $T_J = 25$ °C		1.0	μs
Typical turn-off time	t_q	$I_{TM} = 300$ A, $T_J = T_J$ maximum, $di/dt = 40$ A/μs, $V_R = 50$ V, $dV/dt = 20$ V/μs, gate 0 V 100 Ω, $t_p = 500$ μs		100	

BLOCKING					
PARAMETER	SYMBOL	TEST CONDITIONS		VALUES	UNITS
Maximum critical rate of rise of off-state voltage	dV/dt	$T_J = T_J$ maximum linear to 80 % rated V_{DRM}		500	V/μs
Maximum peak reverse and off-state leakage current	I_{RRM}, I_{DRM}	$T_J = T_J$ maximum, rated V_{DRM}/V_{RRM} applied		50	mA



TRIGGERING						
PARAMETER	SYMBOL	TEST CONDITIONS		VALUES		UNITS
				TYP.	MAX.	
Maximum peak gate power	P_{GM}	$T_J = T_J$ maximum, $t_p \leq 5$ ms		10.0		W
Maximum average gate power	$P_{G(AV)}$	$T_J = T_J$ maximum, $f = 50$ Hz, $d\% = 50$		2.0		
Maximum peak positive gate current	I_{GM}	$T_J = T_J$ maximum, $t_p \leq 5$ ms		3.0		A
Maximum peak positive gate voltage	$+V_{GM}$	$T_J = T_J$ maximum, $t_p \leq 5$ ms		20		V
Maximum peak negative gate voltage	$-V_{GM}$			5.0		
DC gate current required to trigger	I_{GT}	$T_J = -40$ °C	Maximum required gate trigger/ current/voltage are the lowest value which will trigger all units 12 V anode to cathode applied	200	-	mA
		$T_J = 25$ °C		100	200	
		$T_J = 125$ °C		50	-	
DC gate voltage required to trigger	V_{GT}	$T_J = -40$ °C		2.5	-	V
		$T_J = 25$ °C		1.8	3.0	
		$T_J = 125$ °C		1.1	-	
DC gate current not to trigger	I_{GD}	$T_J = T_J$ maximum		10.0		mA
DC gate voltage not to trigger	V_{GD}			0.25		V

THERMAL AND MECHANICAL SPECIFICATIONS				
PARAMETER	SYMBOL	TEST CONDITIONS	VALUES	UNITS
Maximum operating junction temperature range	T_J		- 40 to 125	°C
Maximum storage temperature range	T_{Stg}		- 40 to 150	
Maximum thermal resistance, junction to heatsink	R_{thJ-hs}	DC operation single side cooled	0.09	K/W
		DC operation double side cooled	0.04	
Maximum thermal resistance, case to heatsink	R_{thC-hs}	DC operation single side cooled	0.02	
		DC operation double side cooled	0.01	
Mounting force, ± 10 %			9800 (1000)	N (kg)
Approximate weight			83	g
Case style		See dimensions - link at the end of datasheet	TO-200AB (E-PUK)	

ΔR_{thJ-hs} CONDUCTION						
CONDUCTION ANGLE	SINUSOIDAL CONDUCTION		RECTANGULAR CONDUCTION		TEST CONDITIONS	UNITS
	SINGLE SIDE	DOUBLE SIDE	SINGLE SIDE	DOUBLE SIDE		
180°	0.010	0.011	0.007	0.007	$T_J = T_J$ maximum	K/W
120°	0.012	0.012	0.012	0.013		
90°	0.015	0.015	0.016	0.017		
60°	0.022	0.022	0.023	0.023		
30°	0.036	0.036	0.036	0.037		

Note

- The table above shows the increment of thermal resistance R_{thJ-hs} when devices operate at different conduction angles than DC

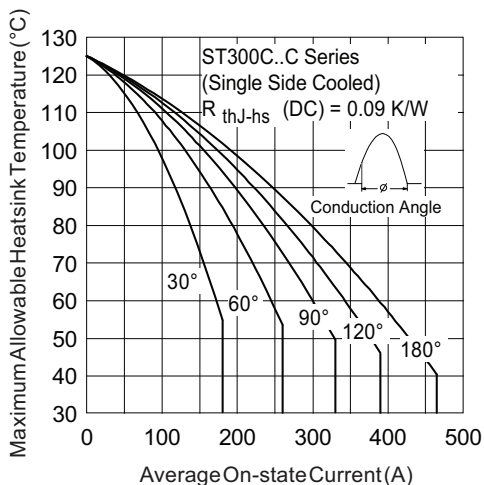

Fig. 1 - Current Ratings Characteristics

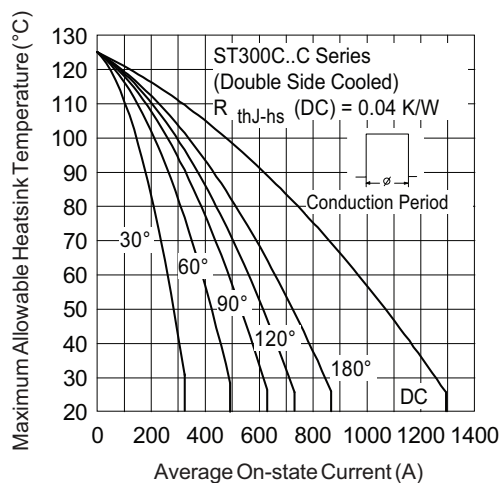

Fig. 4 - Current Ratings Characteristics

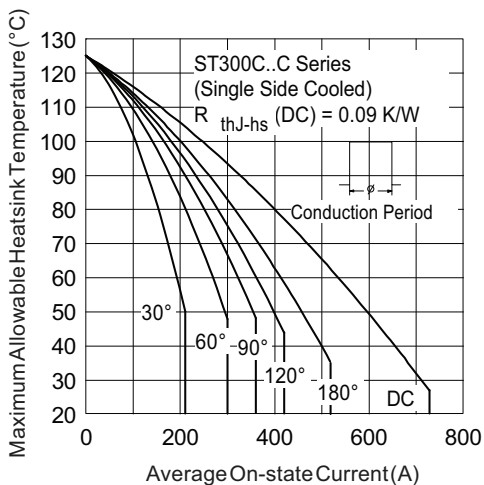

Fig. 2 - Current Ratings Characteristics

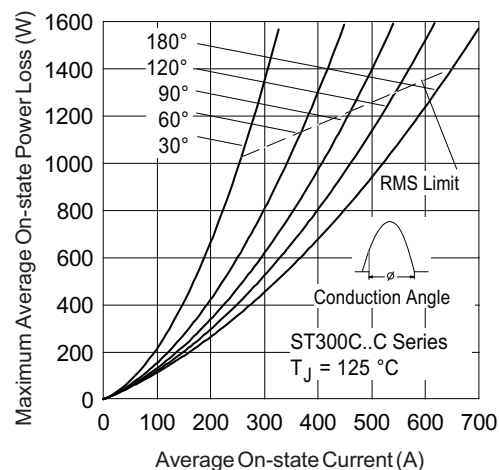

Fig. 5 - On-State Power Loss Characteristics

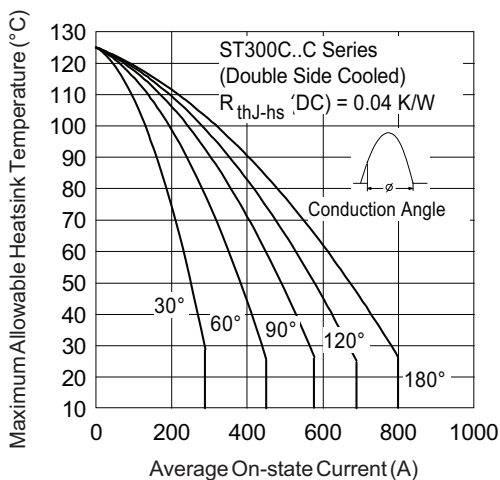

Fig. 3 - Current Ratings Characteristics

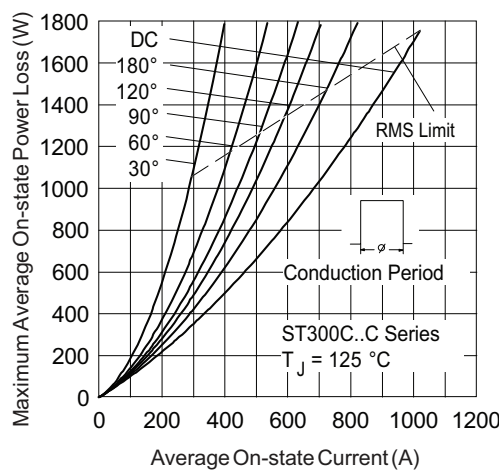

Fig. 6 - On-State Power Loss Characteristics



Fig. 7 - Maximum Non-Repetitive Surge Current Single and Double Side Cooled



Fig. 8 - Maximum Non-Repetitive Surge Current Single and Double Side Cooled



Fig. 9 - On-State Voltage Drop Characteristics



Fig. 10 - Thermal Impedance Z_{thJ-hs} Characteristics

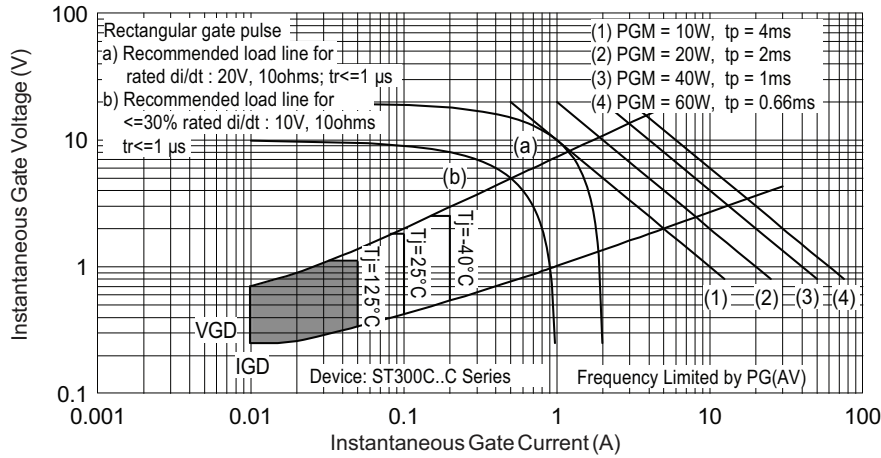

Fig. 11 - Gate Characteristics

ORDERING INFORMATION TABLE

Device code	VS-	ST	30	0	C	20	C	1	-
	1	2	3	4	5	6	7	8	9

- 1** - Vishay Semiconductors product
- 2** - Thyristor
- 3** - Essential part number
- 4** - 0 = Converter grade
- 5** - C = Ceramic PUK
- 6** - Voltage code x 100 = V_{RRM} (see Voltage Ratings table)
- 7** - C = PUK case TO-200AB (E-PUK)
- 8** - 0 = Eyelet terminals (gate and auxiliary cathode unsoldered leads)
 1 = Fast-on terminals (gate and auxiliary cathode unsoldered leads)
 2 = Eyelet terminals (gate and auxiliary cathode soldered leads)
 3 = Fast-on terminals (gate and auxiliary cathode soldered leads)
- 9** - Critical dV/dt : • None = 500 V/ μs (standard value)
 • L = 1000 V/ μs (special selection)

LINKS TO RELATED DOCUMENTS

Dimensions	www.vishay.com/doc?95075
------------	--

TO-200AB (E-PUK)

DIMENSIONS in millimeters (inches)

Anode to gate
 Creepage distance: 11.18 (0.44) minimum
 Strike distance: 7.62 (0.30) minimum

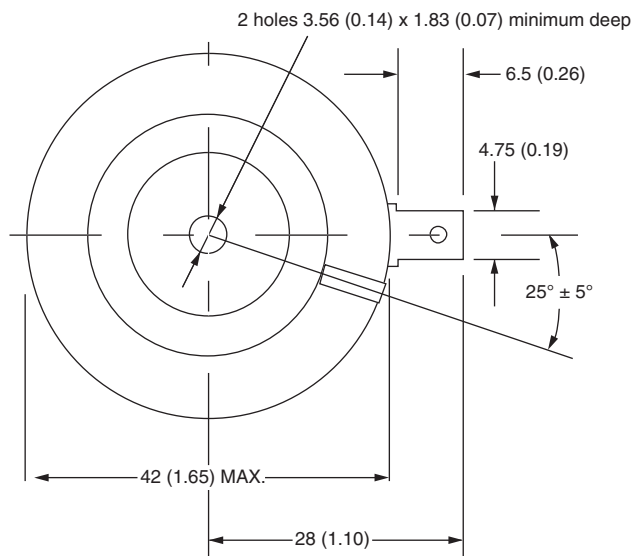

Quote between upper and lower pole pieces has to be considered after application of mounting force (see thermal and mechanical specification)



Disclaimer

ALL PRODUCT, PRODUCT SPECIFICATIONS AND DATA ARE SUBJECT TO CHANGE WITHOUT NOTICE TO IMPROVE RELIABILITY, FUNCTION OR DESIGN OR OTHERWISE.

Vishay Intertechnology, Inc., its affiliates, agents, and employees, and all persons acting on its or their behalf (collectively, "Vishay"), disclaim any and all liability for any errors, inaccuracies or incompleteness contained in any datasheet or in any other disclosure relating to any product.

Vishay makes no warranty, representation or guarantee regarding the suitability of the products for any particular purpose or the continuing production of any product. To the maximum extent permitted by applicable law, Vishay disclaims (i) any and all liability arising out of the application or use of any product, (ii) any and all liability, including without limitation special, consequential or incidental damages, and (iii) any and all implied warranties, including warranties of fitness for particular purpose, non-infringement and merchantability.

Statements regarding the suitability of products for certain types of applications are based on Vishay's knowledge of typical requirements that are often placed on Vishay products in generic applications. Such statements are not binding statements about the suitability of products for a particular application. It is the customer's responsibility to validate that a particular product with the properties described in the product specification is suitable for use in a particular application. Parameters provided in datasheets and / or specifications may vary in different applications and performance may vary over time. All operating parameters, including typical parameters, must be validated for each customer application by the customer's technical experts. Product specifications do not expand or otherwise modify Vishay's terms and conditions of purchase, including but not limited to the warranty expressed therein.

Except as expressly indicated in writing, Vishay products are not designed for use in medical, life-saving, or life-sustaining applications or for any other application in which the failure of the Vishay product could result in personal injury or death. Customers using or selling Vishay products not expressly indicated for use in such applications do so at their own risk. Please contact authorized Vishay personnel to obtain written terms and conditions regarding products designed for such applications.

No license, express or implied, by estoppel or otherwise, to any intellectual property rights is granted by this document or by any conduct of Vishay. Product names and markings noted herein may be trademarks of their respective owners.