



Is Now Part of



**ON Semiconductor®**

To learn more about ON Semiconductor, please visit our website at  
[www.onsemi.com](http://www.onsemi.com)

ON Semiconductor and the ON Semiconductor logo are trademarks of Semiconductor Components Industries, LLC dba ON Semiconductor or its subsidiaries in the United States and/or other countries. ON Semiconductor owns the rights to a number of patents, trademarks, copyrights, trade secrets, and other intellectual property. A listing of ON Semiconductor's product/patent coverage may be accessed at [www.onsemi.com/site/pdf/Patent-Marking.pdf](http://www.onsemi.com/site/pdf/Patent-Marking.pdf). ON Semiconductor reserves the right to make changes without further notice to any products herein. ON Semiconductor makes no warranty, representation or guarantee regarding the suitability of its products for any particular purpose, nor does ON Semiconductor assume any liability arising out of the application or use of any product or circuit, and specifically disclaims any and all liability, including without limitation special, consequential or incidental damages. Buyer is responsible for its products and applications using ON Semiconductor products, including compliance with all laws, regulations and safety requirements or standards, regardless of any support or applications information provided by ON Semiconductor. "Typical" parameters which may be provided in ON Semiconductor data sheets and/or specifications can and do vary in different applications and actual performance may vary over time. All operating parameters, including "Typicals" must be validated for each customer application by customer's technical experts. ON Semiconductor does not convey any license under its patent rights nor the rights of others. ON Semiconductor products are not designed, intended, or authorized for use as a critical component in life support systems or any FDA Class 3 medical devices or medical devices with a same or similar classification in a foreign jurisdiction or any devices intended for implantation in the human body. Should Buyer purchase or use ON Semiconductor products for any such unintended or unauthorized application, Buyer shall indemnify and hold ON Semiconductor and its officers, employees, subsidiaries, affiliates, and distributors harmless against all claims, costs, damages, and expenses, and reasonable attorney fees arising out of, directly or indirectly, any claim of personal injury or death associated with such unintended or unauthorized use, even if such claim alleges that ON Semiconductor was negligent regarding the design or manufacture of the part. ON Semiconductor is an Equal Opportunity/Affirmative Action Employer. This literature is subject to all applicable copyright laws and is not for resale in any manner.



## NDS332P P-Channel Logic Level Enhancement Mode Field Effect Transistor

### General Description

These P-Channel logic level enhancement mode power field effect transistors are produced using Fairchild's proprietary, high cell density, DMOS technology. This very high density process is especially tailored to minimize on-state resistance. These devices are particularly suited for low voltage applications such as notebook computer power management, portable electronics, and other battery powered circuits where fast high-side switching, and low in-line power loss are needed in a very small outline surface mount package.

### Features

- -1 A, -20 V,  $R_{DS(ON)} = 0.41 \Omega @ V_{GS} = -2.7 V$   
 $R_{DS(ON)} = 0.3 \Omega @ V_{GS} = -4.5 V.$
- Very low level gate drive requirements allowing direct operation in 3V circuits.  $V_{GS(th)} < 1.0V.$
- Proprietary package design using copper lead frame for superior thermal and electrical capabilities.
- High density cell design for extremely low  $R_{DS(ON)}$ .
- Exceptional on-resistance and maximum DC current capability.
- Compact industry standard SOT-23 surface Mount package.

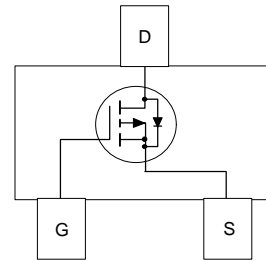
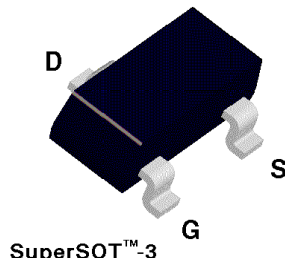

### Absolute Maximum Ratings $T_A = 25^\circ C$ unless otherwise noted

Symbol	Parameter	NDS332P	Units
$V_{DSS}$	Drain-Source Voltage	-20	V
$V_{GSS}$	Gate-Source Voltage - Continuous	$\pm 8$	V
$I_D$	Drain Current - Continuous (Note 1a)	-1	A
	- Pulsed	-10	
$P_D$	Maximum Power Dissipation (Note 1a) (Note 1b)	0.5	W
		0.46	
$T_J, T_{STG}$	Operating and Storage Temperature Range	-55 to 150	$^\circ C$

### THERMAL CHARACTERISTICS

$R_{\theta JA}$	Thermal Resistance, Junction-to-Ambient (Note 1a)	250	$^\circ C/W$
$R_{\theta JC}$	Thermal Resistance, Junction-to-Case (Note 1)	75	$^\circ C/W$

**Electrical Characteristics** ( $T_A = 25^\circ\text{C}$  unless otherwise noted)

Symbol	Parameter	Conditions	Min	Typ	Max	Units	
<b>OFF CHARACTERISTICS</b>							
$BV_{DSS}$	Drain-Source Breakdown Voltage	$V_{GS} = 0\text{ V}, I_D = -250\ \mu\text{A}$	-20			V	
$I_{DSS}$	Zero Gate Voltage Drain Current	$V_{DS} = -16\text{ V}, V_{GS} = 0\text{ V}$			-1	$\mu\text{A}$	
			$T_J = 55^\circ\text{C}$			-10	$\mu\text{A}$
$I_{GSS}$	Gate - Body Leakage Current	$V_{GS} = 8\text{ V}, V_{DS} = 0\text{ V}$			100	nA	
$I_{GSS}$	Gate - Body Leakage Current	$V_{GS} = -8\text{ V}, V_{DS} = 0\text{ V}$			-100	nA	
<b>ON CHARACTERISTICS</b> (Note 2)							
$V_{GS(th)}$	Gate Threshold Voltage	$V_{DS} = V_{GS}, I_D = -250\ \mu\text{A}$		-0.4	-0.6	-1	V
			$T_J = 125^\circ\text{C}$	-0.3	-0.45	-0.8	
$R_{DS(on)}$	Static Drain-Source On-Resistance	$V_{GS} = -2.7\text{ V}, I_D = -1\text{ A}$			0.35	0.41	$\Omega$
			$T_J = 125^\circ\text{C}$			0.5	0.74
			$V_{GS} = -4.5\text{ V}, I_D = -1.1\text{ A}$			0.26	0.3
$I_{D(on)}$	On-State Drain Current	$V_{GS} = -2.7\text{ V}, V_{DS} = -5\text{ V}$		-1.5			A
			$V_{GS} = -4.5\text{ V}, V_{DS} = -5\text{ V}$		-2.5		
$g_{FS}$	Forward Transconductance	$V_{DS} = -5\text{ V}, I_D = -1\text{ A}$		2.2		S	
<b>DYNAMIC CHARACTERISTICS</b>							
$C_{iss}$	Input Capacitance	$V_{DS} = -10\text{ V}, V_{GS} = 0\text{ V},$ $f = 1.0\text{ MHz}$		195		pF	
$C_{oss}$	Output Capacitance			105		pF	
$C_{rss}$	Reverse Transfer Capacitance			40		pF	
<b>SWITCHING CHARACTERISTICS</b> (Note 2)							
$t_{D(on)}$	Turn - On Delay Time	$V_{DD} = -6\text{ V}, I_D = -1\text{ A},$ $V_{GS} = -4.5\text{ V}, R_{GEN} = 6\ \Omega$		8	15	ns	
$t_r$	Turn - On Rise Time			30	45	ns	
$t_{D(off)}$	Turn - Off Delay Time			25	45	ns	
$t_f$	Turn - Off Fall Time			27	45	ns	
$Q_g$	Total Gate Charge		$V_{DS} = -5\text{ V}, I_D = -1\text{ A},$ $V_{GS} = -4.5\text{ V}$		3.7	5	nC
$Q_{gs}$	Gate-Source Charge			0.5		nC	
$Q_{gd}$	Gate-Drain Charge			0.9		nC	

### Electrical Characteristics ( $T_A = 25^\circ\text{C}$ unless otherwise noted)

Symbol	Parameter	Conditions	Min	Typ	Max	Units
<b>DRAIN-SOURCE DIODE CHARACTERISTICS AND MAXIMUM RATINGS</b>						
$I_S$	Maximum Continuous Source Current				-0.42	A
$V_{SD}$	Drain-Source Diode Forward Voltage	$V_{GS} = 0\text{ V}$ , $I_S = -0.42\text{ A}$ (Note 2)		-0.75	-1.2	V

Notes:

- $R_{\theta_{JA}}$  is the sum of the junction-to-case and case-to-ambient thermal resistance where the case thermal reference is defined as the solder mounting surface of the drain pins.  $R_{\theta_{JC}}$  is guaranteed by design while  $R_{\theta_{CA}}$  is determined by the user's board design.

$$P_D(t) = \frac{T_J - T_A}{R_{\theta_{JA}}(t)} = \frac{T_J - T_A}{R_{\theta_{JC}} + R_{\theta_{CA}}(t)} = I_D^2(t) \times R_{DS(ON)} @ T_J$$

Typical  $R_{\theta_{JA}}$  using the board layouts shown below on 4.5"x5" FR-4 PCB in a still air environment:

- 250°C/W when mounted on a 0.02 in<sup>2</sup> pad of 2oz copper.
- 270°C/W when mounted on a 0.001 in<sup>2</sup> pad of 2oz copper.

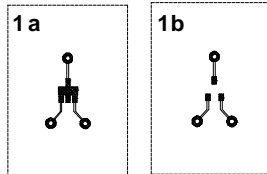

Scale 1 : 1 on letter size paper

- Pulse Test: Pulse Width  $\leq 300\mu\text{s}$ , Duty Cycle  $\leq 2.0\%$ .

## Typical Electrical Characteristics

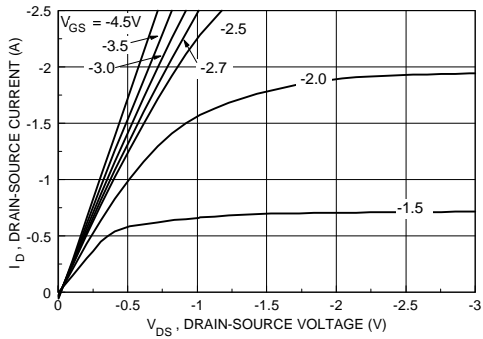

Figure 1. On-Region Characteristics.

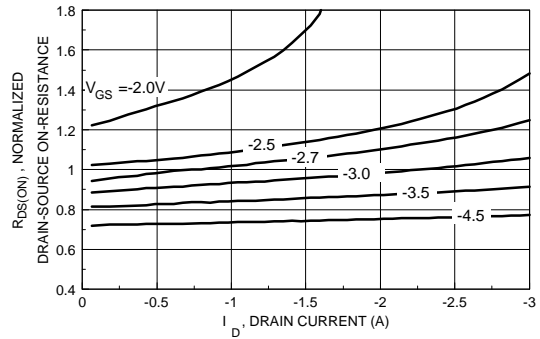

Figure 2. On-Resistance Variation with Drain Current and Gate Voltage.

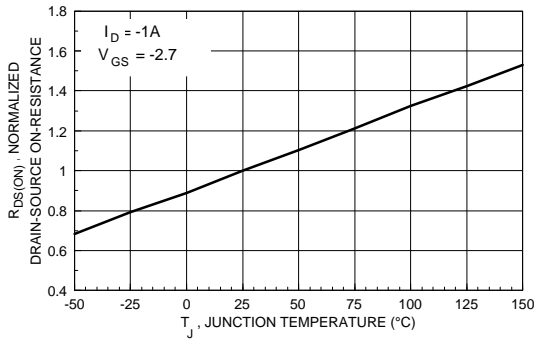

Figure 3. On-Resistance Variation with Temperature.

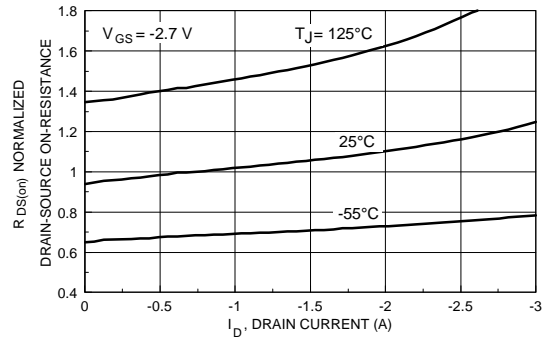

Figure 4. On-Resistance Variation with Drain Current and Temperature.

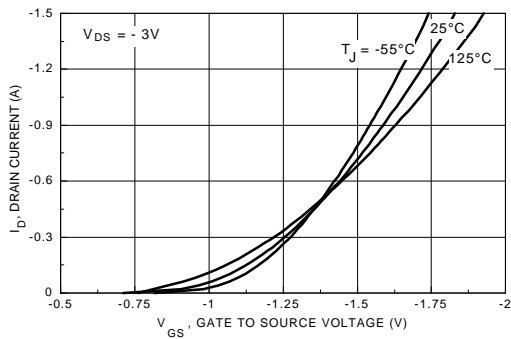

Figure 5. Transfer Characteristics.

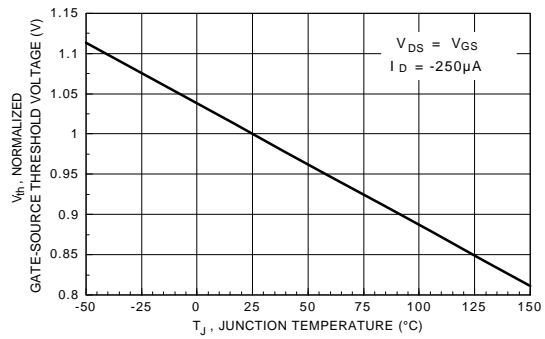

Figure 6. Gate Threshold Variation with Temperature.

## Typical Electrical Characteristics (continued)

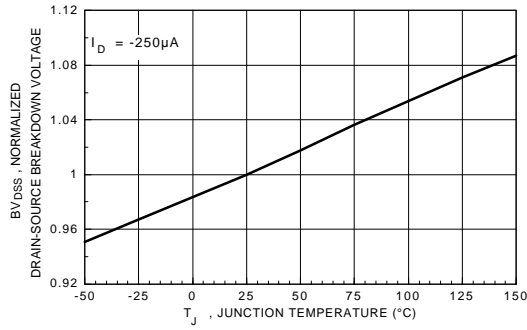

Figure 7. Breakdown Voltage Variation with Temperature.

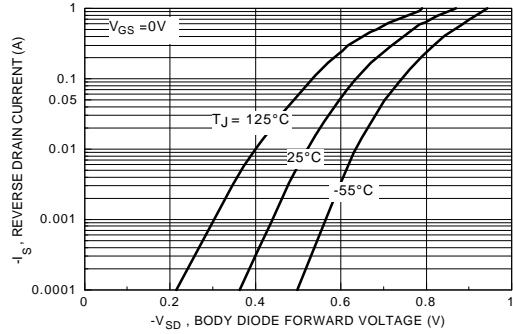

Figure 8. Body Diode Forward Voltage Variation with Source Current and Temperature.

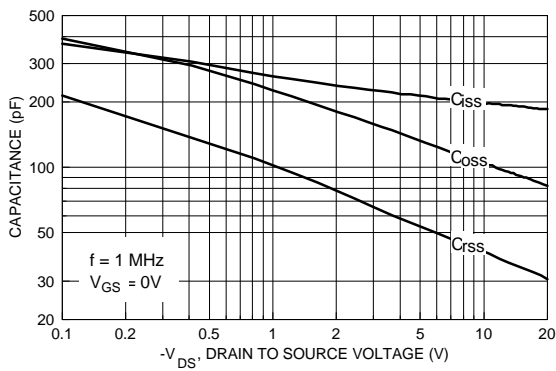

Figure 9. Capacitance Characteristics.

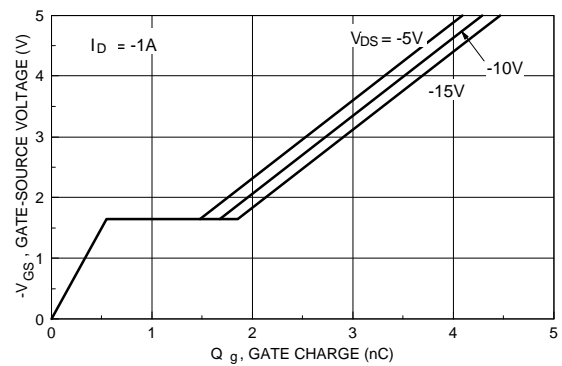

Figure 10. Gate Charge Characteristics.

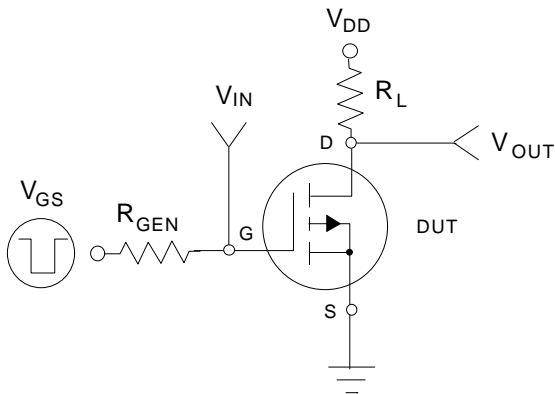

Figure 11. Switching Test Circuit.

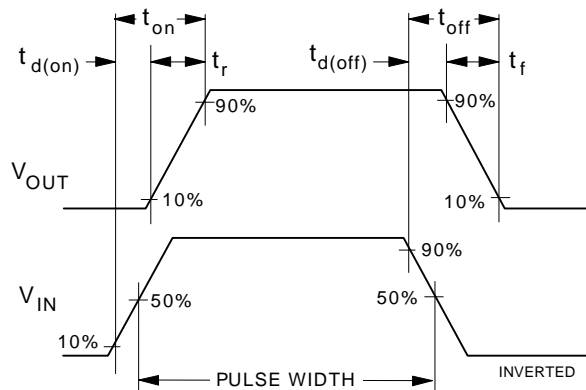
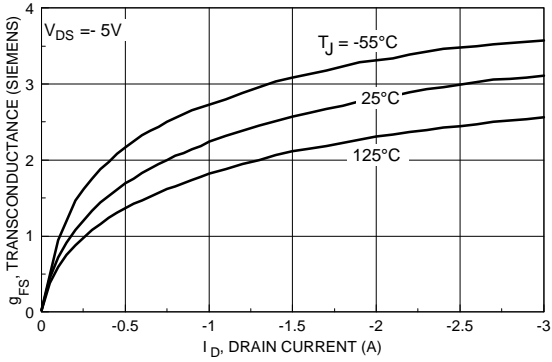
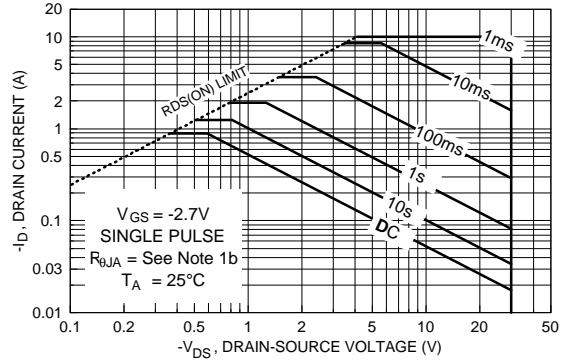

Figure 12. Switching Waveforms.

**Typical Electrical Characteristics (continued)**



**Figure 13. Transconductance Variation with Drain Current and Temperature.**



**Figure 14. Maximum Safe Operating Area.**

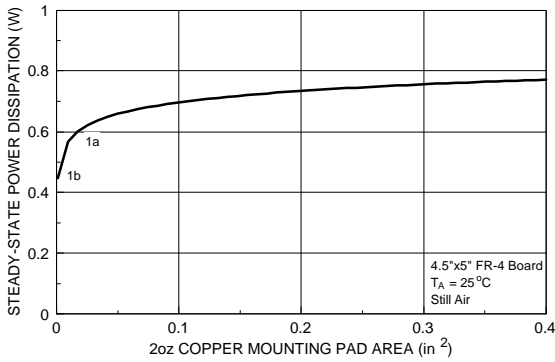

**Figure 15. SuperSOT™-3 Maximum Steady-State Power Dissipation versus Copper Mounting Pad Area.**

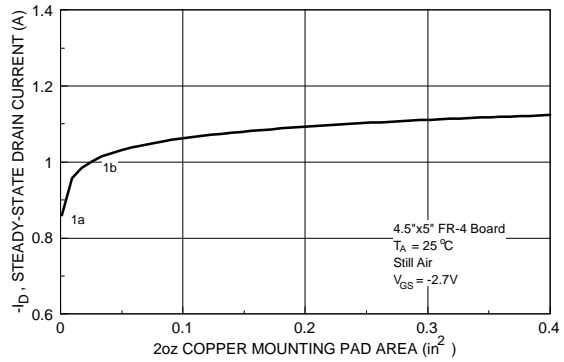

**Figure 16. Maximum Steady-State Drain Current versus Copper Mounting Pad Area.**

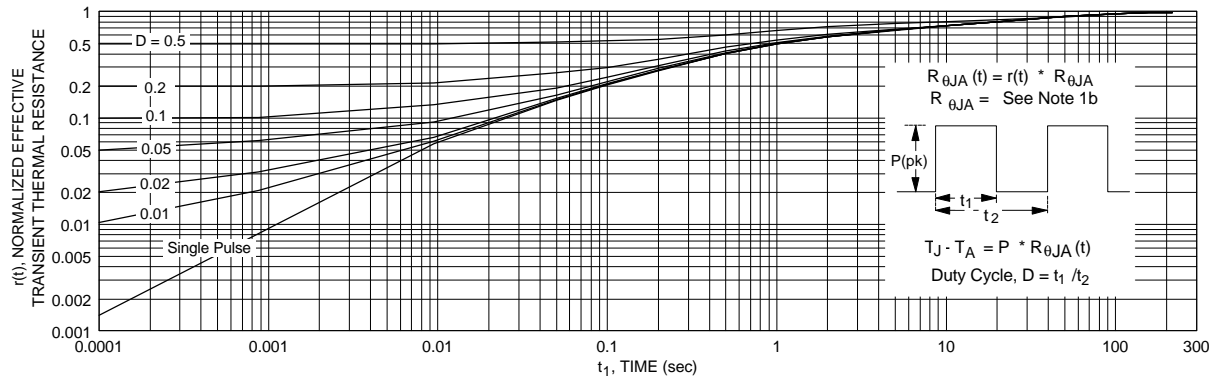





**Figure 17. Transient Thermal Response Curve.**

Note : Characterization performed using the conditions described in note 1b. Transient thermal response will change depending on the circuit board design.



**TRADEMARKS**

The following includes registered and unregistered trademarks and service marks, owned by Fairchild Semiconductor and/or its global subsidiaries, and is not intended to be an exhaustive list of all such trademarks.

- |   |  |   |   |
|---|--|---|---|
| AccuPower™  | F-PFS™   |  |  |
| AX-CAP®*  | FRFET®   | PowerTrench®  | TinyBoost®  |
| BitSiC™   | Global Power Resource <sup>SM</sup>            | PowerXS™  | TinyBuck®   |
| Build it Now™   | GreenBridge™                                   | Programmable Active Droop™  | TinyCalc™   |
| CorePLUS™   | Green FPS™                                     | QFET®   | TinyLogic®  |
| CorePOWER™  | Green FPS™ e-Series™                           | QS™   | TINYOPTO™   |
| CROSSVOL™   | Gmax™  | Quiet Series™   | TinyPower™  |
| CTL™  | GTO™   | RapidConfigure™   | TinyPWM™  |
| Current Transfer Logic™   | IntelliMAX™                                    |  | TinyWire™   |
| DEUXPEED®   | ISOPLANAR™                                     | Saving our world, 1mW/W/kW at a time™   | TranSiC™  |
| Dual Cool™  | Making Small Speakers Sound Louder and Better™ | SignalWise™   | TriFault Detect™  |
| EcoSPARK®   | MegaBuck™                                      | SmartMax™   | TRUECURRENT®*   |
| EfficientMax™   | MICROCOUPLER™                                  | SMART START™  | μSerDes™  |
| ESBC™   | MicroFET™                                      | Solutions for Your Success™   |  |
|  | MicroPak™                                      | SPM®  | UHC®  |
| Fairchild®  | MicroPak2™                                     | STEALTH™  | Ultra FRFET™  |
| Fairchild Semiconductor®  | MillerDrive™                                   | SuperFET®   | UniFET™   |
| FACT Quiet Series™  | MotionMax™                                     | SuperSOT™-3   | VXC™  |
| FACT®   | mWSaver®                                       | SuperSOT™-6   | VisualMax™  |
| FAST®   | OptoHiT™                                       | SuperSOT™-8   | VoltagePlus™  |
| FastvCore™  | OPTOLOGIC®                                     | SupreMOS®   | XS™   |
| FETBench™   | OPTOPLANAR®                                    | SyncFET™  | 仙童™   |
| FPS™  |  | Sync-Lock™  |   |

\* Trademarks of System General Corporation, used under license by Fairchild Semiconductor.

**DISCLAIMER**

FAIRCHILD SEMICONDUCTOR RESERVES THE RIGHT TO MAKE CHANGES WITHOUT FURTHER NOTICE TO ANY PRODUCTS HEREIN TO IMPROVE RELIABILITY, FUNCTION, OR DESIGN. FAIRCHILD DOES NOT ASSUME ANY LIABILITY ARISING OUT OF THE APPLICATION OR USE OF ANY PRODUCT OR CIRCUIT DESCRIBED HEREIN; NEITHER DOES IT CONVEY ANY LICENSE UNDER ITS PATENT RIGHTS, NOR THE RIGHTS OF OTHERS. THESE SPECIFICATIONS DO NOT EXPAND THE TERMS OF FAIRCHILD'S WORLDWIDE TERMS AND CONDITIONS, SPECIFICALLY THE WARRANTY THEREIN, WHICH COVERS THESE PRODUCTS.

**LIFE SUPPORT POLICY**

FAIRCHILD'S PRODUCTS ARE NOT AUTHORIZED FOR USE AS CRITICAL COMPONENTS IN LIFE SUPPORT DEVICES OR SYSTEMS WITHOUT THE EXPRESS WRITTEN APPROVAL OF FAIRCHILD SEMICONDUCTOR CORPORATION.

As used herein:

1. Life support devices or systems are devices or systems which, (a) are intended for surgical implant into the body or (b) support or sustain life, and (c) whose failure to perform when properly used in accordance with instructions for use provided in the labeling, can be reasonably expected to result in a significant injury of the user.
2. A critical component in any component of a life support, device, or system whose failure to perform can be reasonably expected to cause the failure of the life support device or system, or to affect its safety or effectiveness.

**ANTI-COUNTERFEITING POLICY**

Fairchild Semiconductor Corporation's Anti-Counterfeiting Policy. Fairchild's Anti-Counterfeiting Policy is also stated on our external website, [www.fairchildsemi.com](http://www.fairchildsemi.com), under Sales Support.

Counterfeiting of semiconductor parts is a growing problem in the industry. All manufacturers of semiconductor products are experiencing counterfeiting of their parts. Customers who inadvertently purchase counterfeit parts experience many problems such as loss of brand reputation, substandard performance, failed applications, and increased cost of production and manufacturing delays. Fairchild is taking strong measures to protect ourselves and our customers from the proliferation of counterfeit parts. Fairchild strongly encourages customers to purchase Fairchild parts either directly from Fairchild or from Authorized Fairchild Distributors who are listed by country on our web page cited above. Products customers buy either from Fairchild directly or from Authorized Fairchild Distributors are genuine parts, have full traceability, meet Fairchild's quality standards for handling and storage and provide access to Fairchild's full range of up-to-date technical and product information. Fairchild and our Authorized Distributors will stand behind all warranties and will appropriately address any warranty issues that may arise. Fairchild will not provide any warranty coverage or other assistance for parts bought from Unauthorized Sources. Fairchild is committed to combat this global problem and encourage our customers to do their part in stopping this practice by buying direct or from authorized distributors.

**PRODUCT STATUS DEFINITIONS**

**Definition of Terms**

Datasheet Identification	Product Status	Definition
Advance Information	Formative / In Design	Datasheet contains the design specifications for product development. Specifications may change in any manner without notice.
Preliminary	First Production	Datasheet contains preliminary data; supplementary data will be published at a later date. Fairchild Semiconductor reserves the right to make changes at any time without notice to improve design.
No Identification Needed	Full Production	Datasheet contains final specifications. Fairchild Semiconductor reserves the right to make changes at any time without notice to improve the design.
Obsolete	Not In Production	Datasheet contains specifications on a product that is discontinued by Fairchild Semiconductor. The datasheet is for reference information only.

Rev. I68



ON Semiconductor and  are trademarks of Semiconductor Components Industries, LLC dba ON Semiconductor or its subsidiaries in the United States and/or other countries. ON Semiconductor owns the rights to a number of patents, trademarks, copyrights, trade secrets, and other intellectual property. A listing of ON Semiconductor's product/patent coverage may be accessed at [www.onsemi.com/site/pdf/Patent-Marking.pdf](http://www.onsemi.com/site/pdf/Patent-Marking.pdf). ON Semiconductor reserves the right to make changes without further notice to any products herein. ON Semiconductor makes no warranty, representation or guarantee regarding the suitability of its products for any particular purpose, nor does ON Semiconductor assume any liability arising out of the application or use of any product or circuit, and specifically disclaims any and all liability, including without limitation special, consequential or incidental damages. Buyer is responsible for its products and applications using ON Semiconductor products, including compliance with all laws, regulations and safety requirements or standards, regardless of any support or applications information provided by ON Semiconductor. "Typical" parameters which may be provided in ON Semiconductor data sheets and/or specifications can and do vary in different applications and actual performance may vary over time. All operating parameters, including "Typicals" must be validated for each customer application by customer's technical experts. ON Semiconductor does not convey any license under its patent rights nor the rights of others. ON Semiconductor products are not designed, intended, or authorized for use as a critical component in life support systems or any FDA Class 3 medical devices or medical devices with a same or similar classification in a foreign jurisdiction or any devices intended for implantation in the human body. Should Buyer purchase or use ON Semiconductor products for any such unintended or unauthorized application, Buyer shall indemnify and hold ON Semiconductor and its officers, employees, subsidiaries, affiliates, and distributors harmless against all claims, costs, damages, and expenses, and reasonable attorney fees arising out of, directly or indirectly, any claim of personal injury or death associated with such unintended or unauthorized use, even if such claim alleges that ON Semiconductor was negligent regarding the design or manufacture of the part. ON Semiconductor is an Equal Opportunity/Affirmative Action Employer. This literature is subject to all applicable copyright laws and is not for resale in any manner.

## PUBLICATION ORDERING INFORMATION

### LITERATURE FULFILLMENT:

Literature Distribution Center for ON Semiconductor  
19521 E. 32nd Pkwy, Aurora, Colorado 80011 USA  
**Phone:** 303-675-2175 or 800-344-3860 Toll Free USA/Canada  
**Fax:** 303-675-2176 or 800-344-3867 Toll Free USA/Canada  
**Email:** [orderlit@onsemi.com](mailto:orderlit@onsemi.com)

**N. American Technical Support:** 800-282-9855 Toll Free  
USA/Canada  
**Europe, Middle East and Africa Technical Support:**  
Phone: 421 33 790 2910  
**Japan Customer Focus Center**  
Phone: 81-3-5817-1050

**ON Semiconductor Website:** [www.onsemi.com](http://www.onsemi.com)  
**Order Literature:** <http://www.onsemi.com/orderlit>  
For additional information, please contact your local  
Sales Representative