



Is Now Part of



ON Semiconductor®

To learn more about ON Semiconductor, please visit our website at
www.onsemi.com

ON Semiconductor and the ON Semiconductor logo are trademarks of Semiconductor Components Industries, LLC dba ON Semiconductor or its subsidiaries in the United States and/or other countries. ON Semiconductor owns the rights to a number of patents, trademarks, copyrights, trade secrets, and other intellectual property. A listing of ON Semiconductor's product/patent coverage may be accessed at www.onsemi.com/site/pdf/Patent-Marking.pdf. ON Semiconductor reserves the right to make changes without further notice to any products herein. ON Semiconductor makes no warranty, representation or guarantee regarding the suitability of its products for any particular purpose, nor does ON Semiconductor assume any liability arising out of the application or use of any product or circuit, and specifically disclaims any and all liability, including without limitation special, consequential or incidental damages. Buyer is responsible for its products and applications using ON Semiconductor products, including compliance with all laws, regulations and safety requirements or standards, regardless of any support or applications information provided by ON Semiconductor. "Typical" parameters which may be provided in ON Semiconductor data sheets and/or specifications can and do vary in different applications and actual performance may vary over time. All operating parameters, including "Typicals" must be validated for each customer application by customer's technical experts. ON Semiconductor does not convey any license under its patent rights nor the rights of others. ON Semiconductor products are not designed, intended, or authorized for use as a critical component in life support systems or any FDA Class 3 medical devices or medical devices with a same or similar classification in a foreign jurisdiction or any devices intended for implantation in the human body. Should Buyer purchase or use ON Semiconductor products for any such unintended or unauthorized application, Buyer shall indemnify and hold ON Semiconductor and its officers, employees, subsidiaries, affiliates, and distributors harmless against all claims, costs, damages, and expenses, and reasonable attorney fees arising out of, directly or indirectly, any claim of personal injury or death associated with such unintended or unauthorized use, even if such claim alleges that ON Semiconductor was negligent regarding the design or manufacture of the part. ON Semiconductor is an Equal Opportunity/Affirmative Action Employer. This literature is subject to all applicable copyright laws and is not for resale in any manner.



May 2016

FODM3062, FODM3063, FODM3082, FODM3083 4-Pin Full Pitch Mini-Flat Package Zero-Cross Triac Driver Output Optocouplers

Features

- Critical Rate of Rise of Off-Stage Voltage
- dv/dt of 600 V/ μ s Guaranteed
- Zero Voltage Crossing
- Peak Blocking Voltage
- 600 V (FODM306X)
- 800 V (FODM308X)
- Compact 4-Pin Surface Mount Package
- 2.4 mm Maximum Standoff Height
- Safety Regulatory Approvals:
- UL1577, 3,750 VAC_{RMS} for 1 Minute
- DIN-EN/IEC60747-5-5, 565 V Peak Working Insulation Voltage

Applications

- Solenoid/valve controls
- Lighting controls
- Static power switches
- AC motor drives
- Temperature controls
- E.M. contactors
- AC motor starters
- Solid state relays

Description

The FODM306X and FODM308X series consist of an infrared emitting diode optically coupled to a monolithic silicon detector performing the function of a zero voltage crossing bilateral triac driver, and is housed in a compact 4-pin mini-flat package. The lead pitch is 2.54 mm. They are designed for use with a triac in the interface of logic systems to equipment powered from 115/240 VAC lines, such as solid state relays, industrial controls, motors, solenoids and consumer appliances.

Functional Schematic

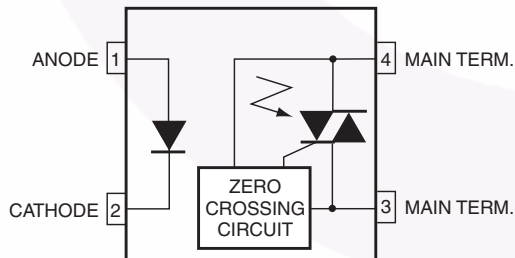

Figure 1. Functional Schematic

Package Outlines

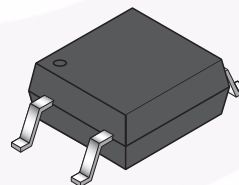

Figure 2. Package Outline

Safety and Insulation Ratings

As per DIN EN/IEC 60747-5-5, this optocoupler is suitable for “safe electrical insulation” only within the safety limit data. Compliance with the safety ratings shall be ensured by means of protective circuits.

Parameter		Characteristics
Installation Classifications per DIN VDE 0110/1.89 Table 1, For Rated Mains Voltage	< 150 V _{RMS}	I–IV
	< 300 V _{RMS}	I–III
Climatic Classification		40/100/21
Pollution Degree (DIN VDE 0110/1.89)		2
Comparative Tracking Index		175

Symbol	Parameter	Value	Unit
V _{PR}	Input-to-Output Test Voltage, Method A, V _{IORM} × 1.6 = V _{PR} , Type and Sample Test with t _m = 10 s, Partial Discharge < 5 pC	904	V _{peak}
	Input-to-Output Test Voltage, Method B, V _{IORM} × 1.875 = V _{PR} , 100% Production Test with t _m = 1 s, Partial Discharge < 5 pC	1060	V _{peak}
V _{IORM}	Maximum Working Insulation Voltage	565	V _{peak}
V _{IOTM}	Highest Allowable Over-Voltage	6000	V _{peak}
	External Creepage	≥ 5	mm
	External Clearance	≥ 5	mm
DTI	Distance Through Insulation (Insulation Thickness)	≥ 0.4	mm
T _S	Case Temperature ⁽¹⁾	150	°C
I _{S,INPUT}	Input Current ⁽¹⁾	200	mA
P _{S,OUTPUT}	Output Power ⁽¹⁾	300	mW
R _{IO}	Insulation Resistance at T _S , V _{IO} = 500 V ⁽¹⁾	> 10 ⁹	Ω

Note:

1. Safety limit values – maximum values allowed in the event of a failure.

Absolute Maximum Ratings

Stresses exceeding the absolute maximum ratings may damage the device. The device may not function or be operable above the recommended operating conditions and stressing the parts to these levels is not recommended. In addition, extended exposure to stresses above the recommended operating conditions may affect device reliability. The absolute maximum ratings are stress ratings only. $T_A = 25^\circ\text{C}$ unless otherwise specified.

Symbol	Parameter	Value	Unit	
T_{STG}	Storage Temperature	-55 to +150	$^\circ\text{C}$	
T_{OPR}	Operating Temperature	-40 to +100	$^\circ\text{C}$	
T_J	Junction Temperature	-40 to +125	$^\circ\text{C}$	
T_{SOL}	Lead Solder Temperature	260 for 10 sec	$^\circ\text{C}$	
EMITTER				
I_F (avg)	Continuous Forward Current	60	mA	
I_F (pk)	Peak Forward Current (1 μs pulse, 300 pps.)	1	A	
V_R	Reverse Input Voltage	6	V	
$P_{D(EMITTER)}$	Power Dissipation (No derating required over operating temp. range)	100	mW	
DETECTOR				
$I_{T(RMS)}$	On-State RMS Current	70	mA	
V_{DRM}	Off-State Output Terminal Voltage	FODM3062/FODM3063	600	V
		FODM3082/FODM3083	800	V
$P_{D(DETECTOR)}$	Power Dissipation (No derating required over operating temp. range)	300	mW	

Electrical Characteristics

$T_A = 25^\circ\text{C}$ unless otherwise specified.

Individual Component Characteristics

Symbol	Parameter	Test Conditions	Device	Min.	Typ.	Max.	Unit
EMITTER							
V_F	Input Forward Voltage	$I_F = 30\text{ mA}$	All			1.50	V
I_R	Reverse Leakage Current	$V_R = 6\text{ V}$	All			100	μA
DETECTOR							
I_{DRM}	Peak Blocking Current Either Direction	Rated V_{DRM} , $I_F = 0^{(2)}$	All			500	nA
dv/dt	Critical Rate of Rise of Off-State Voltage	$I_F = 0$ (Figure 10) ⁽³⁾	All	600			V/ μs

Transfer Characteristics

Symbol	Parameter	Test Conditions	Device	Min.	Typ.	Max.	Unit
I_{FT}	LED Trigger Current	Main Terminal Voltage = $3\text{ V}^{(4)}$	FODM3062, FODM3082 FODM3063, FODM3083			10 5	mA
I_H	Holding Current, Either Direction		All		300		μA
V_{TM}	Peak On-State Voltage, Either Direction	$I_F = \text{Rated } I_{\text{FT}}$, $I_{\text{TM}} = 100\text{ mA peak}$	All			3	V

Zero Crossing Characteristics

Symbol	Parameter	Test Conditions	Device	Min.	Typ.	Max.	Unit
V_{IH}	Inhibit Voltage, MT1-MT2 Voltage above which device will not trigger	$I_{\text{FT}} = \text{Rated } I_{\text{FT}}$	All			20	V
I_{DRM2}	Leakage in Inhibit State	$I_{\text{FT}} = \text{Rated } I_{\text{FT}}$, Rated V_{DRM} , Off-State	All			2	mA

Isolation Characteristics

Symbol	Parameter	Test Conditions	Device	Min.	Typ.	Max.	Unit
V_{ISO}	Steady State Isolation Voltage ⁽⁵⁾	1 Minute, R.H. = 40% to 60%	All	3,750			VAC_{RMS}

Notes:

- Test voltage must be applied within dv/dt rating.
- This is static dv/dt. See Figure 10 for test circuit. Commutating dv/dt is function of the load-driving thyristor(s) only.
- All devices are guaranteed to trigger at an I_F value less than or equal to max I_{FT} . Therefore, recommended operating I_F lies between max I_{FT} (10mA for FODM3062/82, 5mA for FODM3063/83) and absolute max I_F (60 mA).
- Steady state isolation voltage, V_{ISO} , is an internal device dielectric breakdown rating. For this test, pins 1 & 2 are common, and pins 3 & 4 are common.

Typical Performance Characteristics

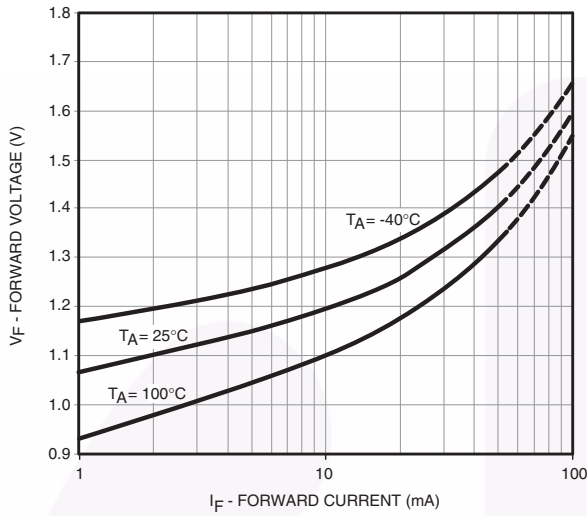

Fig. 3 LED Forward Voltage vs. Forward Current

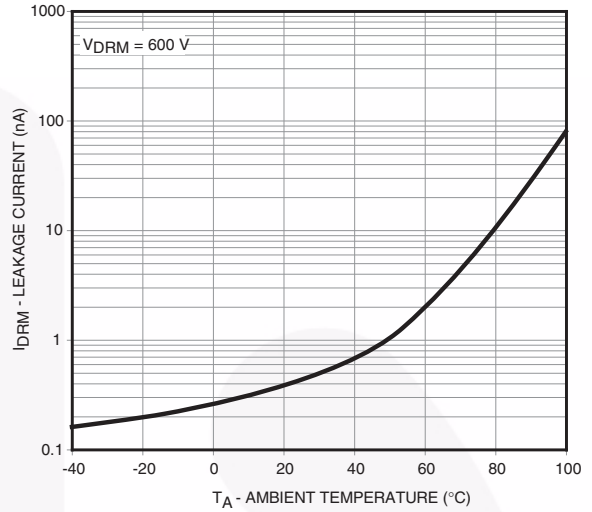

Fig. 4 Leakage Current vs. Ambient Temperature

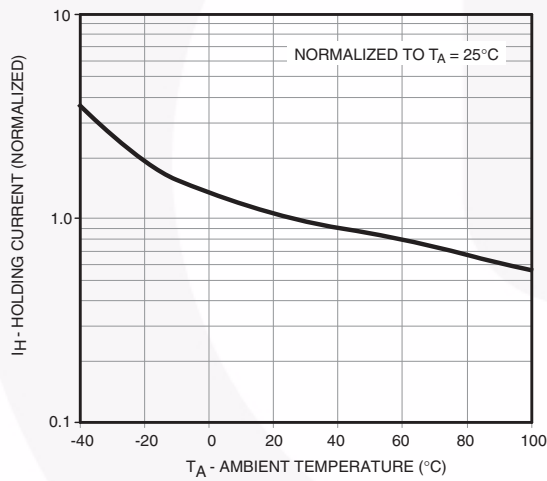

Fig. 5 Holding Current vs. Ambient Temperature

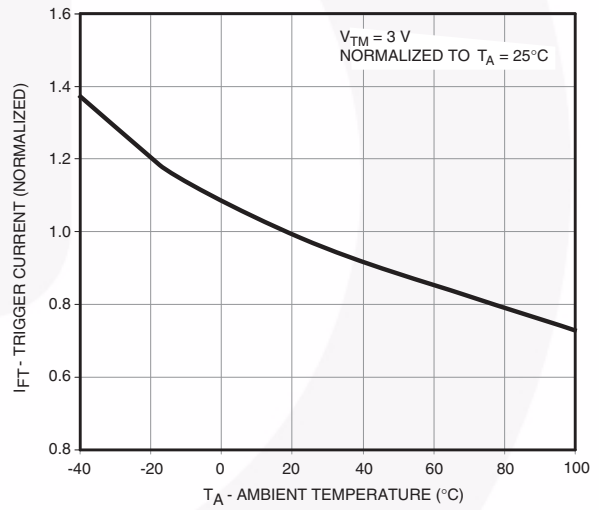

Fig. 6 Trigger Current vs. Ambient Temperature

Typical Performance Characteristics (Continued)

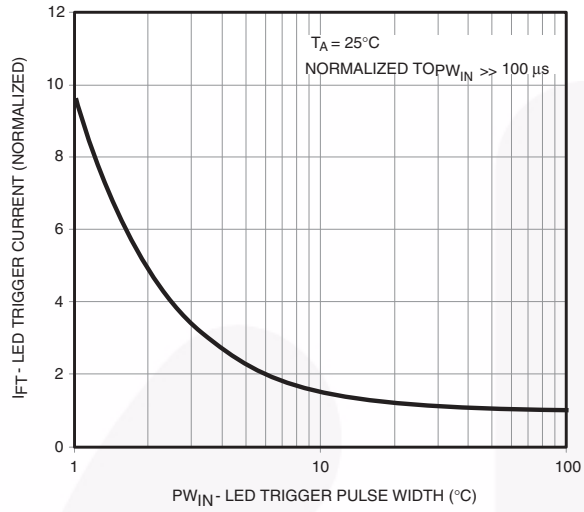

Fig. 7 LED Current Required to Trigger vs. LED Pulse Width

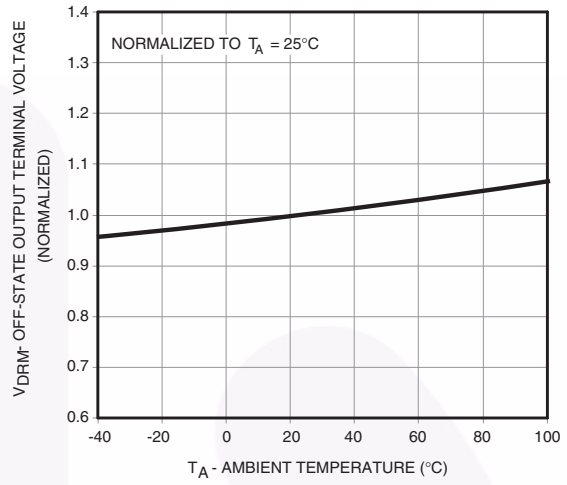

Fig. 8 Off-State Output Terminal Voltage vs. Ambient Temperature

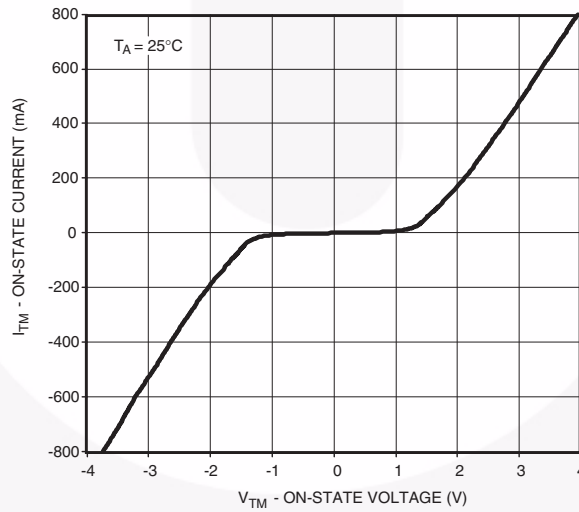

Fig. 9 On-State Characteristics

Typical Application Information

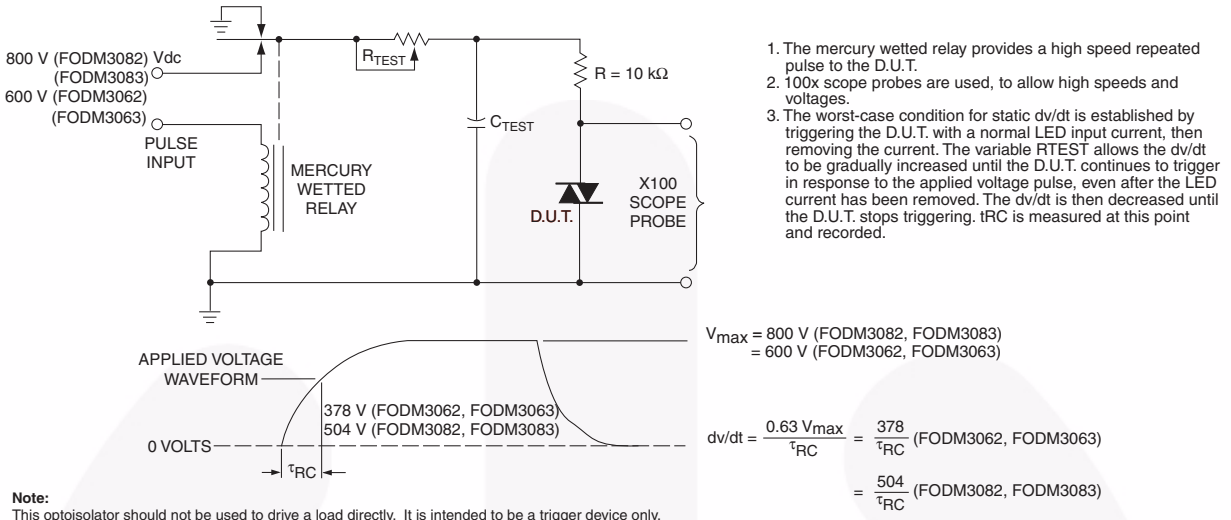

Figure 10. Static dv/dt Test Circuit

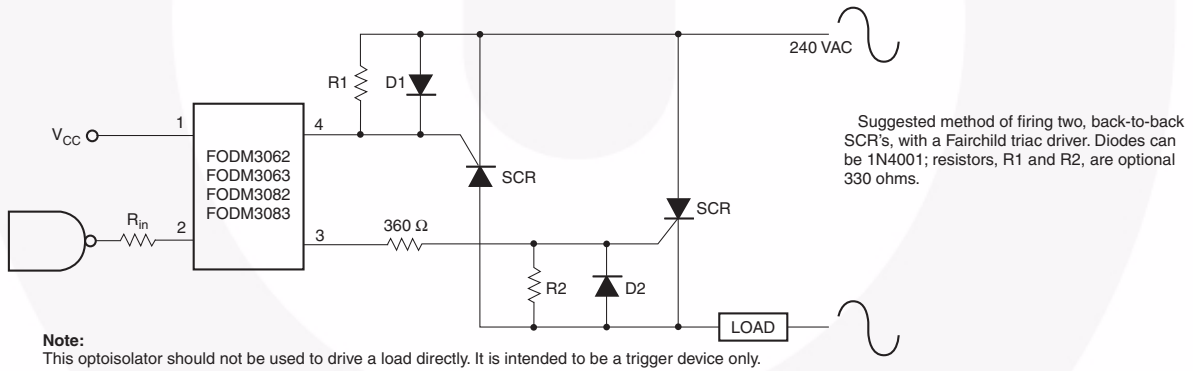

Figure 11. Inverse-Parallel SCR Driver Circuit (240 VAC)

Determining the Power Rating of the Series Resistors Used in a Zero-Cross Opto-TRIAC Driver Application

The following will present the calculations for determining the power dissipation of the current limiting resistors found in an opto-TRIAC driver interface.

Figure 12 shows a typical circuit to drive a sensitive gate four quadrant power TRIAC. This figure provides typical resistor values for a zero line cross detecting opto-TRIAC when operated from a mains voltage of 20 V to 240 V. The wattage rating for each resistor is not given because their dissipation is dependent upon characteristics of the power TRIAC being driven.

Recall that the opto-TRIAC is used to trigger a four quadrant power TRIAC. Please note that these opto-TRIACs are not recommended for driving “snubberless” three quadrant power TRIACs.

Under normal operation, the opto-TRIAC will fire when the mains voltage is lower than the minimum inhibit trigger voltage, and the LED is driven at a current greater than the maximum LED trigger current. As an example for the FODM3063, the LED trigger current should be greater than 5mA, and the mains voltage is less than 10 V peak. The inhibit voltage has a typical range of 10 V minimum and 20 V maximum. This means that if a sufficient LED current is flowing when the mains voltage is less than 10 V, the device will fire. If a trigger appears between 10 V and 20 V, the device may fire. If the trigger occurs after the mains voltage has reached 20 V_{peak}, the device will not fire.

The power dissipated from resistors placed in series with the opto-TRIAC and the gate of the power TRIAC is much smaller than one would expect. These current handling components only conduct current when the mains voltage is less than the maximum inhibit voltage. If the opto-TRIAC is triggered when the mains voltage is greater than the inhibit voltage, only the TRIAC leakage current will flow. The power dissipation in a 360 Ω resistor shown in Figure 12 is the product of the resistance (360 Ω) times the square of the current sum of main TRIAC’s gate current plus the current flowing gate to the MT2 resistor connection (330 Ω). This power calculation is further modified by the duty factor of the duration for this current flow. The duty factor is the ratio of the turn-on time of the main TRIAC to the sine of the single cycle time. Assuming a main TRIAC turn-on time of 50 μs and a 60 Hz mains voltage, the duty cycle is approximately 0.6 %. The opto-TRIAC only conducts current while triggering the main TRIAC. Once the main TRIAC fires, its on-state voltage is typically lower than the on-state sustaining voltage of the opto-TRIAC. Thus, once the main TRIAC fires, the opto-TRIAC is often shunted off. This situation results in very low power dissipation for both the 360 Ω and 330 Ω resistors, when driving a traditional four quadrant power TRIAC.

If a three quadrant “snubberless” TRIAC is driven by the opto-TRIAC, the calculations are different. When the main power TRIAC is driving a high power factor (resistive) load, it shuts off during the fourth quadrant.

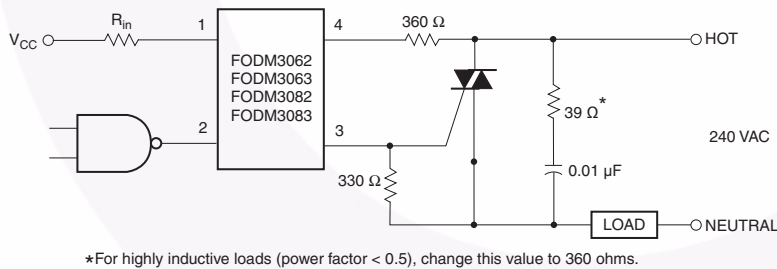

Typical circuit for use when hot line switching of 240 VAC is required. In this circuit the “hot” side of the line is switched and the load connected to the cold or neutral side. The load may be connected to either the neutral or hot line.

R_{in} is calculated so that I_F is equal to the rated I_{FT} of the part, 5 mA for the FODM3063/83 and 10 mA for the FODM3062/82. The 39 Ω resistor and 0.01 μF capacitor are for snubbing of the triac and may or may not be necessary depending upon the particular triac and load used.

*For highly inductive loads (power factor < 0.5), change this value to 360 ohms.

Figure 12. Hot-Line Switching Application Circuit

If sufficient holding current is still flowing through the opto-TRIAC, the opto-TRIAC will turn-on and attempt to carry the power TRIACs load. This situation typically causes the opto-TRIAC to operate beyond its maximum current rating, and product and resistor failures typically result. For this reason, using an opto-TRIAC to drive a three quadrant “snubberless” power TRIAC is not recommended.

Power in the 360 Ω resistor, when driving a sensitive gate 4 quadrant power TRIAC:

$$\begin{aligned} I_{GT} &= 20 \text{ mA} \\ V_{GT} &= 1.5 \text{ V} \\ DF &= 0.6 \% \end{aligned}$$

$$P = (I_{GT} + V_{GT}/330 \Omega)^2 \times 360 \Omega \times DF$$

$$P = (20 \text{ mA} + 1.5/330 \Omega)^2 \times 360 \Omega \times 0.6 \% = 1.3 \text{ mW}$$

A 1/4 watt resistor is more than adequate for both the 360 Ω and 330 Ω resistors.

The real power in the snubber resistor is based upon the integral of the power transient present when the load commutes. A fast commuting transient may allow a peak current of 4 A to 8 A in the snubbing filter. For best results, the capacitor should be a non-polarized AC unit with a low ESR. The 39 Ω series resistor sets a time constant and limits the peak current. For a resistive load with a power factor near unity, the commutating transients will be small. This results in a very small peak current given the 0.01 μF capacitor's reactance. Normally, for fractional horse-power reactive loads, the resistor found in the snubber circuit will have a power rating from 1/2 W to 2 W. The resistor should be a low inductance type to adequately filter the high frequency transients.

Reflow Profile

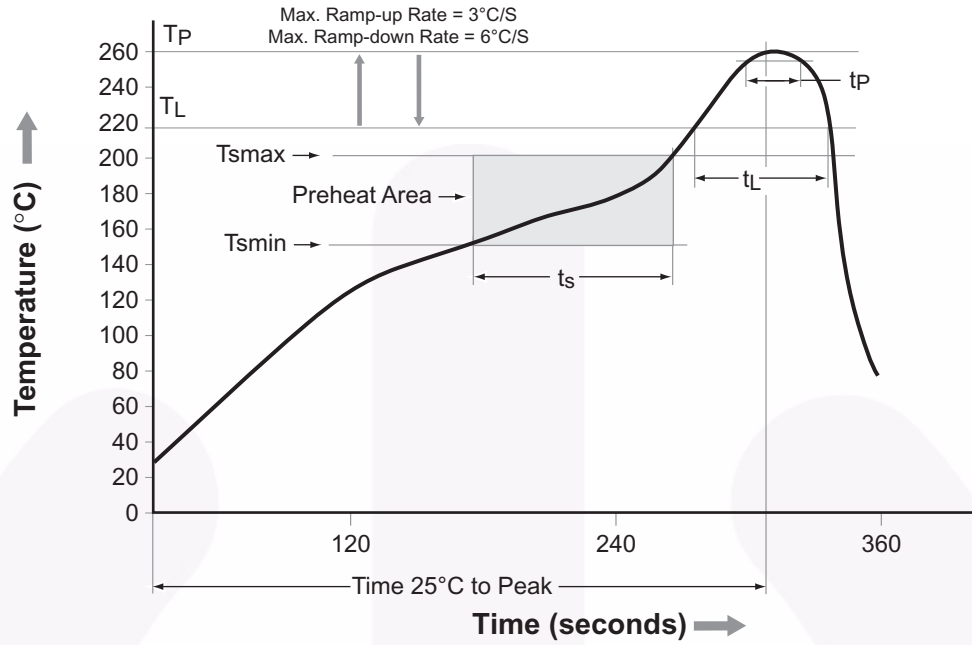

Profile Feature	Pb-Free Assembly Profile
Temperature Min. (T_{smin})	150°C
Temperature Max. (T_{smax})	200°C
Time (t_s) from (T_{smin} to T_{smax})	60–120 seconds
Ramp-up Rate (t_L to t_P)	3°C/second max.
Liquidous Temperature (T_L)	217°C
Time (t_L) Maintained Above (T_L)	60–150 seconds
Peak Body Package Temperature	260°C +0°C / -5°C
Time (t_p) within 5°C of 260°C	30 seconds
Ramp-down Rate (T_P to T_L)	6°C/second max.
Time 25°C to Peak Temperature	8 minutes max.

Ordering Information

Part Number	Package	Packing Method
FODM3063	Full Pitch Mini-Flat 4-Pin	Tube (100 units)
FODM3063R2	Full Pitch Mini-Flat 4-Pin	Tape and Reel (2500 Units)
FODM3063V	Full Pitch Mini-Flat 4-Pin, DIN EN/IEC60747-5-5 Option	Tube (100 Units)
FODM3063R2V	Full Pitch Mini-Flat 4-Pin, DIN EN/IEC60747-5-5 Option	Tape and Reel (2500 Units)

Note:

The product orderable part number system listed in this table also applies to the FODM3062, FODM3082 and FODM3083 products.

Marking Information

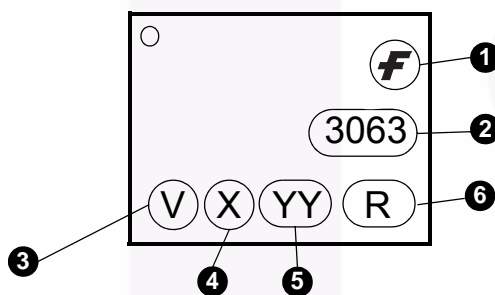
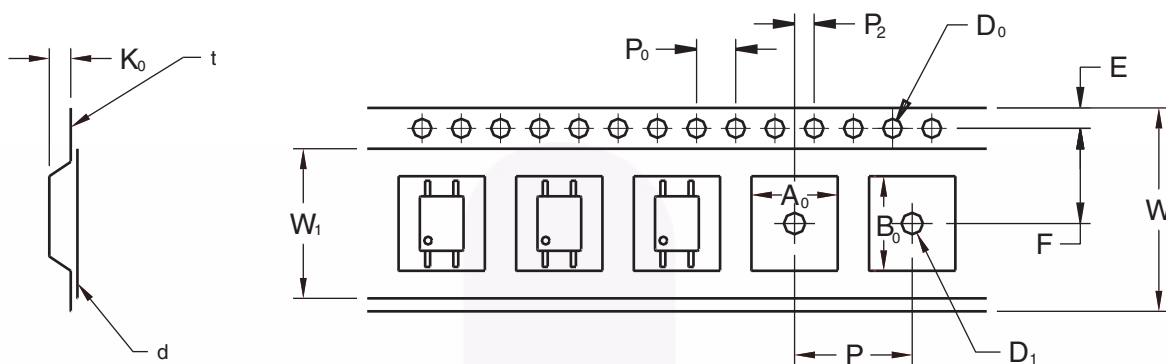

Figure 13. Top Mark

Table 1. Top Mark Definitions

1	Fairchild Logo
2	Device Number
3	DIN EN/IEC60747-5-5 Option (only appears on component ordered with this option)
4	One-Digit Year Code, e.g., "6"
5	Digit Work Week, Ranging from "01" to "53"
6	Assembly Package Code

Tape Specifications



		2.54 Pitch
Description	Symbol	Dimensions
Tape Width	W	12.00±0.4
Tape Thickness	t	0.35±0.02
Sprocket Hole Pitch	P ₀	4.00±0.20
Sprocket Hole Dia.	D ₀	1.55±0.20
Sprocket Hole Location	E	1.75±0.20
Pocket Location	F	5.50±0.20
	P ₂	2.00±0.20
Pocket Pitch	P	8.00±0.20
Pocket Dimension	A ₀	4.75±0.20
	B ₀	7.30±0.20
	K ₀	2.30±0.20
Pocket Hole Dia.	D ₁	1.55±0.20
Cover Tape Width	W ₁	9.20
Cover Tape Thickness	d	0.065±0.02
Max. Component Rotation or Tilt		20° max
Devices Per Reel		2500
Reel Diameter		330 mm (13")

Footprint Drawing for PCB Layout

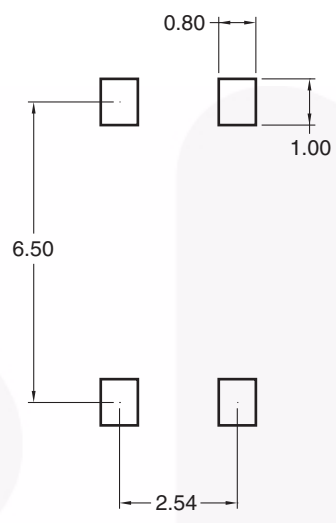

Note:
All dimensions are in mm.



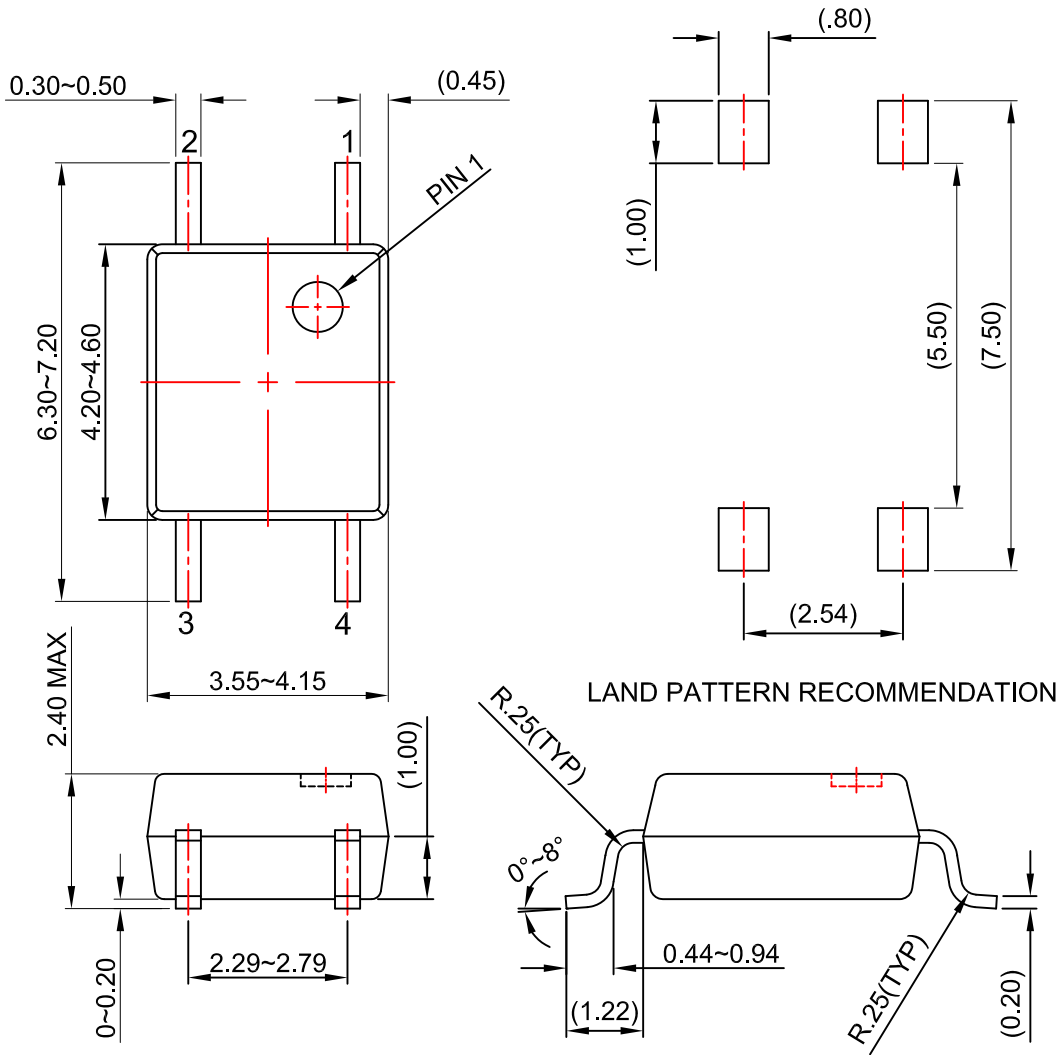

NOTES:

- A) NO STANDARD APPLIES TO THIS PACKAGE.
- B) ALL DIMENSIONS ARE IN MILLIMETERS.
- C) DIMENSIONS ARE EXCLUSIVE OF BURRS, MOLD FLASH, AND TIE BAR EXTRUSION
- D) DRAWING FILENAME AND REVISION: MKT-MFP04Crev3.



ON Semiconductor and  are trademarks of Semiconductor Components Industries, LLC dba ON Semiconductor or its subsidiaries in the United States and/or other countries. ON Semiconductor owns the rights to a number of patents, trademarks, copyrights, trade secrets, and other intellectual property. A listing of ON Semiconductor's product/patent coverage may be accessed at www.onsemi.com/site/pdf/Patent-Marking.pdf. ON Semiconductor reserves the right to make changes without further notice to any products herein. ON Semiconductor makes no warranty, representation or guarantee regarding the suitability of its products for any particular purpose, nor does ON Semiconductor assume any liability arising out of the application or use of any product or circuit, and specifically disclaims any and all liability, including without limitation special, consequential or incidental damages. Buyer is responsible for its products and applications using ON Semiconductor products, including compliance with all laws, regulations and safety requirements or standards, regardless of any support or applications information provided by ON Semiconductor. "Typical" parameters which may be provided in ON Semiconductor data sheets and/or specifications can and do vary in different applications and actual performance may vary over time. All operating parameters, including "Typicals" must be validated for each customer application by customer's technical experts. ON Semiconductor does not convey any license under its patent rights nor the rights of others. ON Semiconductor products are not designed, intended, or authorized for use as a critical component in life support systems or any FDA Class 3 medical devices or medical devices with a same or similar classification in a foreign jurisdiction or any devices intended for implantation in the human body. Should Buyer purchase or use ON Semiconductor products for any such unintended or unauthorized application, Buyer shall indemnify and hold ON Semiconductor and its officers, employees, subsidiaries, affiliates, and distributors harmless against all claims, costs, damages, and expenses, and reasonable attorney fees arising out of, directly or indirectly, any claim of personal injury or death associated with such unintended or unauthorized use, even if such claim alleges that ON Semiconductor was negligent regarding the design or manufacture of the part. ON Semiconductor is an Equal Opportunity/Affirmative Action Employer. This literature is subject to all applicable copyright laws and is not for resale in any manner.

PUBLICATION ORDERING INFORMATION

LITERATURE FULFILLMENT:

Literature Distribution Center for ON Semiconductor
19521 E. 32nd Pkwy, Aurora, Colorado 80011 USA
Phone: 303-675-2175 or 800-344-3860 Toll Free USA/Canada
Fax: 303-675-2176 or 800-344-3867 Toll Free USA/Canada
Email: orderlit@onsemi.com

N. American Technical Support: 800-282-9855 Toll Free
USA/Canada
Europe, Middle East and Africa Technical Support:
Phone: 421 33 790 2910
Japan Customer Focus Center
Phone: 81-3-5817-1050

ON Semiconductor Website: www.onsemi.com
Order Literature: <http://www.onsemi.com/orderlit>
For additional information, please contact your local
Sales Representative