

FEATURES

High linearity: supports modulations to 1024 QAM

Tx IF range: 200 MHz to 700 MHz

Tx RF range: 800 MHz to 4000 MHz

Tx power control: 25 dB

SPI controlled interface

32-lead, 5 mm × 5 mm LFCSP package

APPLICATIONS

Point to point communications

Satellite communications

Wireless microwave backhaul systems

FUNCTIONAL BLOCK DIAGRAM

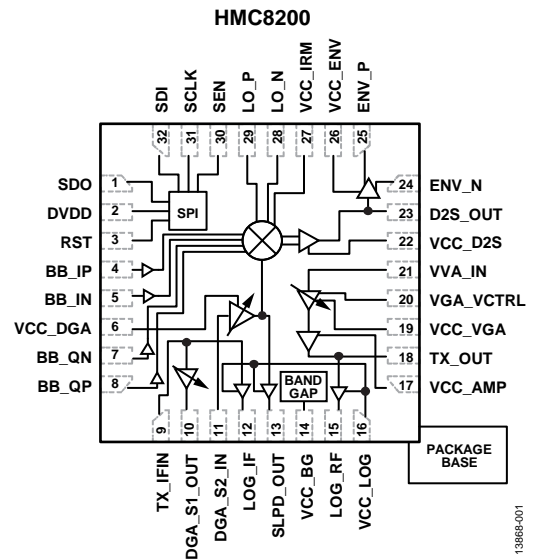

Figure 1.

GENERAL DESCRIPTION

The [HMC8200LP5ME](#) is a highly integrated intermediate frequency (IF) transmitter chip that converts the industry standard 300 MHz to 400 MHz IF input signals to an 800 MHz to 4000 MHz single-ended radio frequency (RF) signal at its output.

The IF transmitter chip is housed in a compact 5 mm × 5 mm LFCSP package and supports complex modulations up to 1024 QAM. The [HMC8200LP5ME](#) simultaneously reduces the design complexity of traditional microwave radios while realizing significant size and cost improvements. With IF input power ranges from -31 dBm to +4 dBm, the [HMC8200LP5ME](#)

provides 35 dB of digital gain control in 1 dB steps and an analog voltage gain amplifier (VGA) continuously controls the transmitter output power from -20 dBm to +5 dBm.

The device also features three integrated power detectors. The first detector (LOG_IF) can be utilized to monitor the IF input power. The second detector (SLPD_OUT) is a square law power detector that monitors the power entering the mixer. The third power detector (LOG_RF) is used to monitor the output power, which can be used for fine output power adjustment.

TABLE OF CONTENTS

Features	1	ESD Caution.....	6
Applications.....	1	Pin Configuration and Function Descriptions.....	7
Functional Block Diagram	1	Typical Performance Characteristics	8
General Description	1	Theory of Operation	18
Revision History	2	Register Array Assignments and Serial Interface	18
Specifications.....	3	Register Descriptions	20
Electrical Characteristics: 800 MHz to 1800 MHz RF		Register Array Assignments.....	20
Frequency Range	3	Evaluation Printed Circuit Board (PCB).....	23
Electrical Characteristics: 1800 MHz to 2800 MHz RF		Evaluation PCB Schematic.....	24
Frequency Range	4	Outline Dimensions	25
Electrical Characteristics: 2800 MHz to 4000 MHz RF		Ordering Guide	25
Frequency Range	5		
Absolute Maximum Ratings.....	6		

REVISION HISTORY

2/2017—Rev. B to Rev. C

Changes to Figure 60.....	18
Updated Outline Dimensions	25

This Hittite Microwave Products data sheet has been reformatted to meet the styles and standards of Analog Devices, Inc.

6/2016—v01.0216 to Rev. B

Updated Format.....	Universal
Added Pin Configuration Diagram; Renumbered Sequentially	7
Added Ordering Guide.....	22

SPECIFICATIONS

T_A = 25°C, IF frequency = 350 MHz, local oscillator (LO) input signal level = 0 dBm, RF input signal level = -31 dBm per tone, DGA setting (dec) = 35 (maximum gain), VGA setting = 3.3 V (maximum gain), sideband select = lower sideband, unless otherwise noted.

ELECTRICAL CHARACTERISTICS: 800 MHz TO 1800 MHz RF FREQUENCY RANGE

Table 1.

Parameter	Min	Typ	Max	Unit
OPERATING CONDITIONS				
LO Frequency Range	300		2300	MHz
IF Frequency Range	200		700	MHz
IF INPUT INTERFACE				
Input Impedance		50		Ω
Return Loss		20		dB
LOG IF Power Detector 1 dB Dynamic Range		50		dB
LOG IF Power Detector Range	-30		+10	dBm
LOG IF Power Detector Slope		37		mV/dB
Square Log Power Detector Range		17		dB
RF OUTPUT INTERFACE				
Input Impedance		50		Ω
Return Loss	7	13		dB
LOG Power Detector 1 dB Dynamic Range		50		dB
LOG Power Detector Range	-25		+10	dBm
LOG Power Detector Slope		37		mV/dB
LO INPUT INTERFACE				
Input Impedance		50		Ω
Return Loss	7	12		dB
DYNAMIC PERFORMANCE				
Conversion Gain	30	34		dB
Digital VGA Dynamic Range	30	35		dB
Analog VGA Dynamic Range	23	27		dB
Sideband Rejection ¹	28	32		dBc
Noise Figure		6		dB
Output Third-Order Intercept (OIP3)	28	31		dBm
Output 1 dB Compression Point (OP1dB)	11	15		dBm
LO to RF Rejection ¹		30		dBc
IF to RF Rejection	56	63		dBc
POWER SUPPLY				
Supply Voltage				
V _{CCx}		3.3		V
VCC_VGA ²		3.3		V
Supply Current				
V _{CCx}		540		mA
VCC_VGA ²		11		μA

¹ Measurement was taken uncalibrated.

² VCC_VGA can be adjusted from 3.3 V (maximum gain) to 0 V (minimum gain) to control the RF VGA.

ELECTRICAL CHARACTERISTICS: 1800 MHz TO 2800 MHz RF FREQUENCY RANGE

Table 2.

Parameter	Min	Typ	Max	Unit
OPERATING CONDITIONS				
LO Frequency Range	1300		3300	MHz
IF Frequency Range	200		700	MHz
IF INPUT INTERFACE				
Input Impedance		50		Ω
Return Loss		20		dB
LOG IF Power Detector 1 dB Dynamic Range		50		dB
LOG IF Power Detector Range	-30		+10	dBm
LOG IF Power Detector Slope		37		mV/dB
Square Log Power Detector Range		17		dB
RF OUTPUT INTERFACE				
Input Impedance		50		Ω
Return Loss	12	15		dB
LOG Power Detector 1 dB Dynamic Range		50		dB
LOG Power Detector Range	-25		+10	dBm
LOG Power Detector Slope		37		mV/dB
LO INPUT INTERFACE				
Input Impedance		50		Ω
Return Loss	8	15		dB
DYNAMIC PERFORMANCE				
Conversion Gain	28	32		dB
Digital VGA Dynamic Range	30	35		dB
Analog VGA Dynamic Range	22	26		dB
Sideband Rejection ¹	28	32		dBc
Noise Figure		5.5		dB
Output Third-Order Intercept (OIP3)	25	28		dBm
Output 1 dB Compression Point (OP1dB)	10	15		dBm
LO to RF Rejection ¹		34		dBc
IF to RF Rejection	55	58		dBc
POWER SUPPLY				
Supply Voltage				
V _{CCx}		3.3		V
VCC_VGA ²		3.3		V
Supply Current				
V _{CCx}		540		mA
VCC_VGA ²		11		μ A

¹ Measurement was taken uncalibrated.² VCC_VGA can be adjusted from 3.3 V (maximum gain) to 0 V (minimum gain) to control the RF VGA.

ELECTRICAL CHARACTERISTICS: 2800 MHz TO 4000 MHz RF FREQUENCY RANGE

Table 3.

Parameter	Min	Typ	Max	Unit
OPERATING CONDITIONS				
LO Frequency Range	2300		4500	MHz
IF Frequency Range	200		700	MHz
IF INPUT INTERFACE				
Input Impedance		50		Ω
Return Loss		20		dB
LOG IF Power Detector 1 dB Dynamic Range		50		dB
LOG IF Power Detector Range	-30		+10	dBm
LOG IF Power Detector Slope		37		mV/dB
Square Log Power Detector Range		17		dB
RF OUTPUT INTERFACE				
Input Impedance		50		Ω
Return Loss	15	23		dB
LOG Power Detector 1 dB Dynamic Range		50		dB
LOG Power Detector Range	-25		+10	dBm
LOG Power Detector Slope		37		mV/dB
LO INPUT INTERFACE				
Input Impedance		50		Ω
Return Loss	12	17		dB
DYNAMIC PERFORMANCE				
Conversion Gain	22	30		dB
Digital VGA Dynamic Range	30	35		dB
Analog VGA Dynamic Range	20	25		dB
Sideband Rejection ¹	22	30		dBc
Noise Figure		5.5		dB
Output Third-Order Intercept (OIP3)	20	26		dBm
Output 1 dB Compression Point (OP1dB)	7	14		dBm
LO to RF Rejection ¹		32		dBc
IF to RF Rejection	50	55		dBc
POWER SUPPLY				
Supply Voltage				
V _{CCx}		3.3		V
VCC_VGA ²		3.3		V
Supply Current				
V _{CCx}		540		mA
VCC_VGA ²		11		μ A

¹ Measurement was taken uncalibrated.² VCC_VGA can be adjusted from 3.3 V (maximum gain) to 0 V (minimum gain) to control the RF VGA.

ABSOLUTE MAXIMUM RATINGS

Table 4.

Parameter	Rating
IF Input	10 dBm
LO Input	10 dBm
V _{CCx}	-0.5 V to +5.5 V
Digital Input/Output	-0.3 V to +3.6 V
Maximum Junction Temperature to Maintain 1 Million Hour MTTF	150°C
Thermal Resistance (R _{TH}), Junction to Ground Paddle	11°C/W
Temperature	
Operating	-40°C to +85°C
Storage	-65°C to +150°C
Maximum Peak Reflow Temperature (MSL3)	260°C
ESD Sensitivity (Human Body Model)	2000 V (Class 2)

Stresses at or above those listed under Absolute Maximum Ratings may cause permanent damage to the product. This is a stress rating only; functional operation of the product at these or any other conditions above those indicated in the operational section of this specification is not implied. Operation beyond the maximum operating conditions for extended periods may affect product reliability.

ESD CAUTION



ESD (electrostatic discharge) sensitive device. Charged devices and circuit boards can discharge without detection. Although this product features patented or proprietary protection circuitry, damage may occur on devices subjected to high energy ESD. Therefore, proper ESD precautions should be taken to avoid performance degradation or loss of functionality.

PIN CONFIGURATION AND FUNCTION DESCRIPTIONS

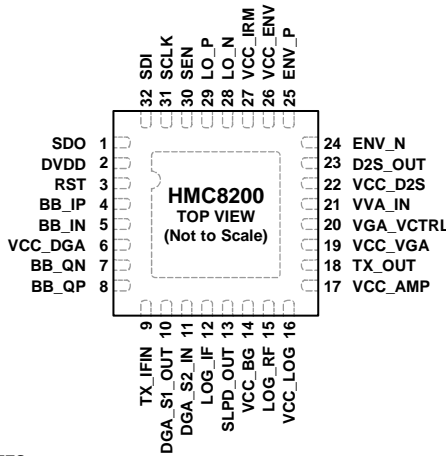

NOTES
 1. CONNECT EXPOSED GROUND PADDLE TO RF/DC GROUND.

Figure 2. Pin Configuration

13868-100

Table 5. Pin Function Descriptions

Pin No.	Mnemonic	Description
1	SDO	SPI Serial Data Output.
2	DVDD	SPI Digital Supply. Refer to Figure 64 for the required external components.
3	RST	SPI Reset. Connect to logic high for normal operation.
4, 5	BB_IP, BB_IN	Positive and Negative Filter Baseband IF I Inputs.
6	VCC_DGA	Power Supply for the Digital Variable Gain Amplifier. Refer to Figure 64 for the required external components.
7, 8	BB_QN, BB_QP	Negative and Positive Filter Baseband IF Q Inputs.
9	TX_IFIN	Transmit (Tx) IF Input, Intermediate Frequency Input Port. This pin is matched to 50 Ω.
10	DGA_S1_OUT	Power Supply for the First Stage Digital Gain Amplifier. This pin is matched to 50 Ω. Refer to Figure 64 for the required external components.
11	DGA_S2_IN	Second Stage Digital Gain Amplifier Input.
12	LOG_IF	IF Log Detector Output.
13	SLPD_OUT	Square Law Detector Output.
14	VCC_BG	Band Gap Supply. Power Supply Voltage for the Bias Controller. Refer to Figure 64 for the required external components.
15	LOG_RF	RF Log Detector Output.
16	VCC_LOG	RF Log Detector Supply. Refer to Figure 64 for the required external components.
17	VCC_AMP	Power Supply for the RF Output Amplifier. Refer to Figure 64 for the required external components.
18	TX_OUT	Tx Chip Output.
19	VCC_VGA	Power Supply for the Variable Gain Amplifier. Refer to Figure 64 for the required external components.
20	VGA_VCTRL	VGA Control Voltage. Refer to Figure 64 for the required external components.
21	VVA_IN	VVA Intermediate Frequency Input Port. This pin is matched to 50 Ω.
22	VCC_D2S	Differential to Single Amplifier Supply. Refer to Figure 64 for the required external components.
23	D2S_OUT	Differential to Single Amplifier Intermediate Frequency Output Port. This pin is matched to 50 Ω.
24, 25	ENV_N, ENV_P	Envelope Detector Outputs.
26	VCC_ENV	Envelope Detector Supply. Refer to Figure 64 for the required external components.
27	VCC_IRM	Power Supply for the Mixer Output. Refer to Figure 64 for the required external components.
28, 29	LO_N, LO_P	Local Oscillator Inputs. These pins are ac-coupled and matched to 50 Ω.
30	SEN	SPI Serial Enable.
31	SCLK	SPI Clock Digital Input.
32	SDI	SPI Serial Data Input.
	EPAD	Exposed Pad. Connect exposed ground paddle to RF/dc ground.

TYPICAL PERFORMANCE CHARACTERISTICS

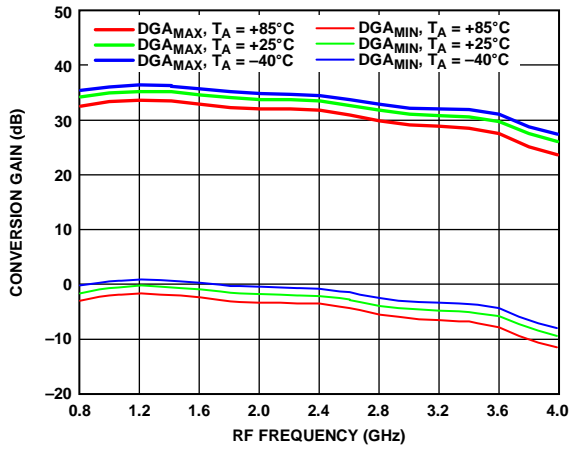

Figure 3. Conversion Gain vs. RF Frequency over Temperature, Lower Sideband

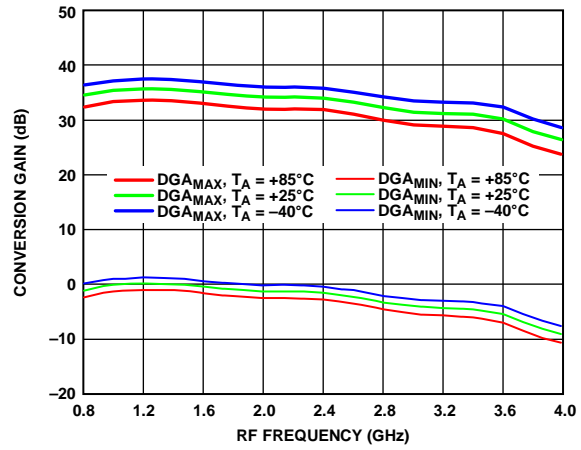

Figure 6. Conversion Gain vs. RF Frequency over Temperature, Upper Sideband

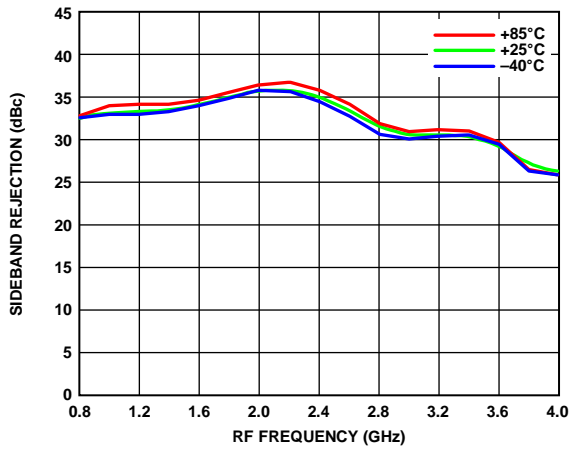

Figure 4. Sideband Rejection vs. RF Frequency over Temperature, Lower Sideband

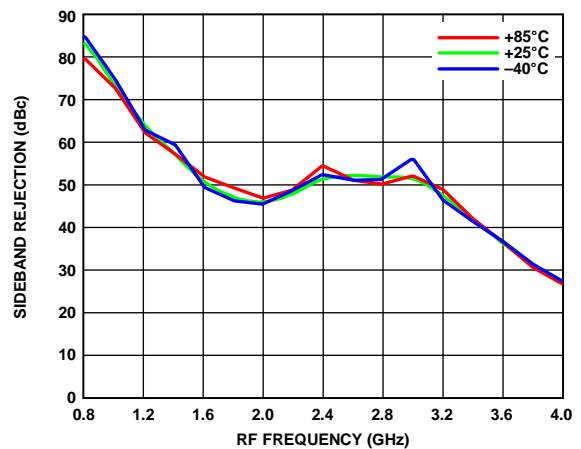

Figure 7. Sideband Rejection vs. RF Frequency over Temperature, Upper Sideband

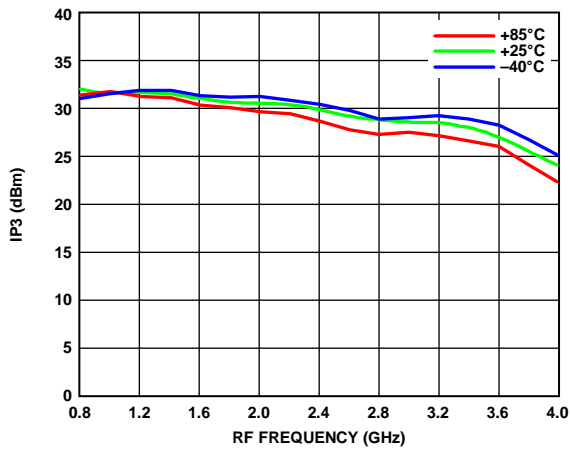

Figure 5. Output IP3 vs. RF Frequency over Temperature, Lower Sideband

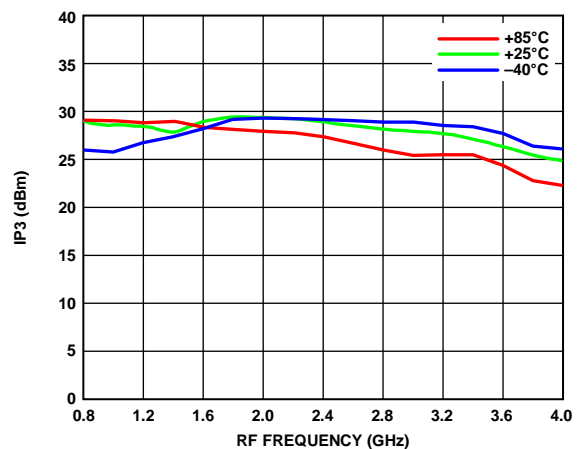

Figure 8. Output IP3 vs. RF Frequency over Temperature, Upper Sideband

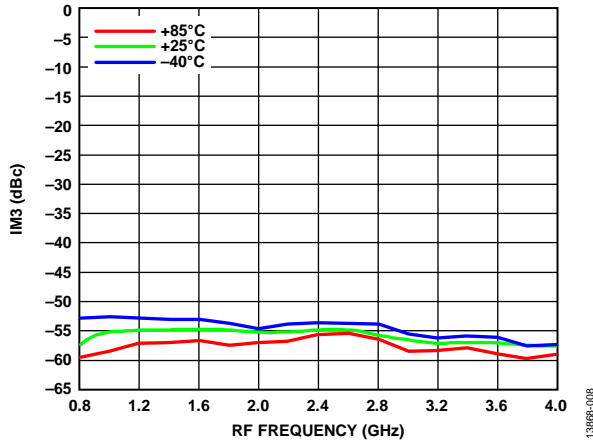

Figure 9. IM3 vs. RF Frequency over Temperature, Lower Sideband

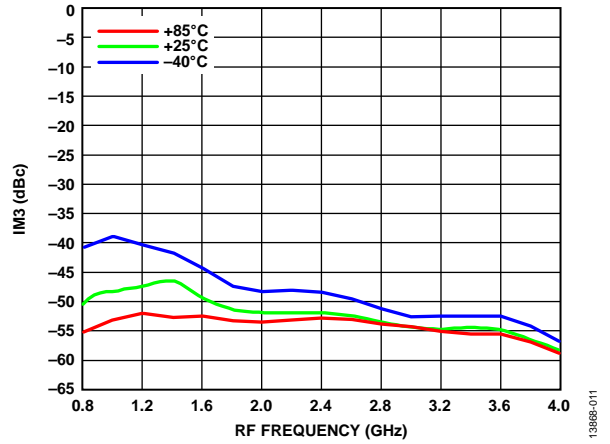

Figure 12. IM3 vs. RF Frequency over Temperature, Upper Sideband

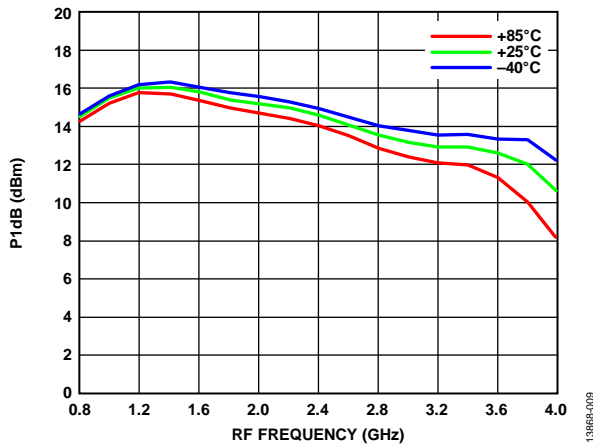

Figure 10. Output P1dB vs. RF Frequency over Temperature, Lower Sideband

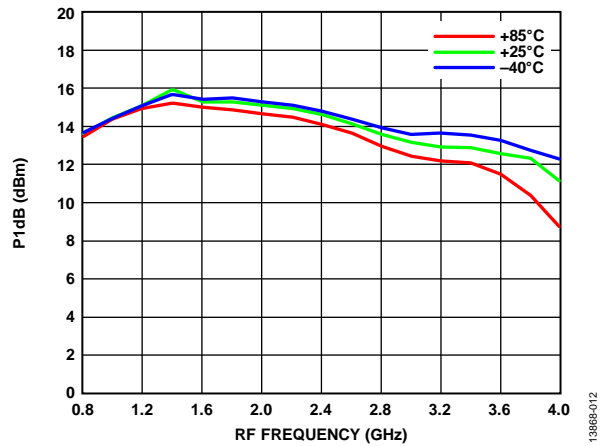

Figure 13. Output P1dB vs. RF Frequency over Temperature, Upper Sideband

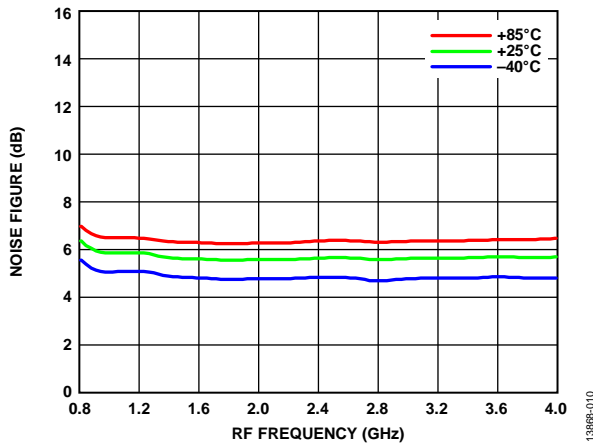

Figure 11. Noise Figure vs. RF Frequency over Temperature, Lower Sideband

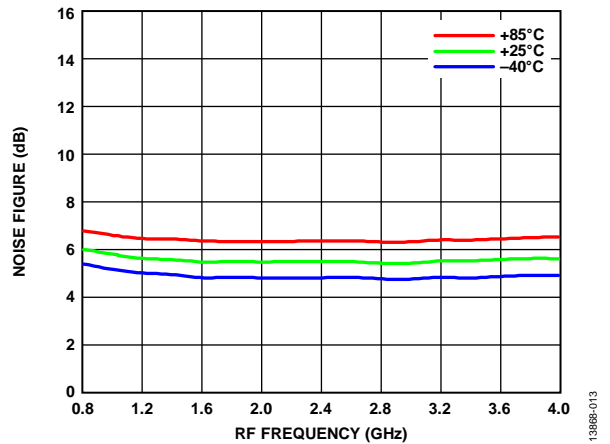

Figure 14. Noise Figure vs. RF Frequency over Temperature, Upper Sideband

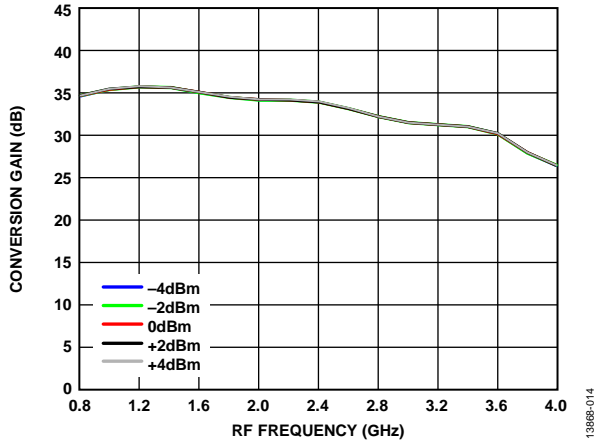

Figure 15. Conversion Gain vs. RF Frequency at Various LO Powers

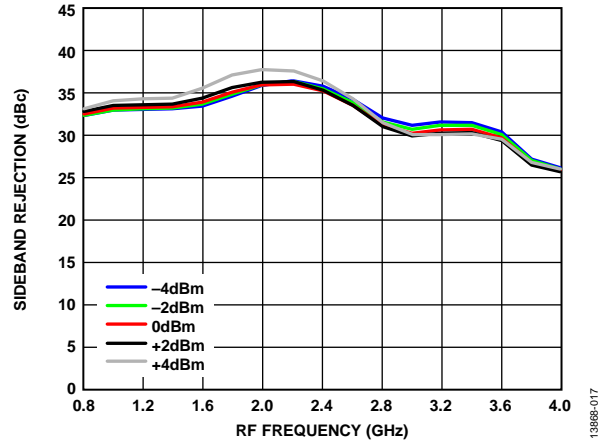

Figure 18. Sideband Rejection vs. RF Frequency at Various LO Powers

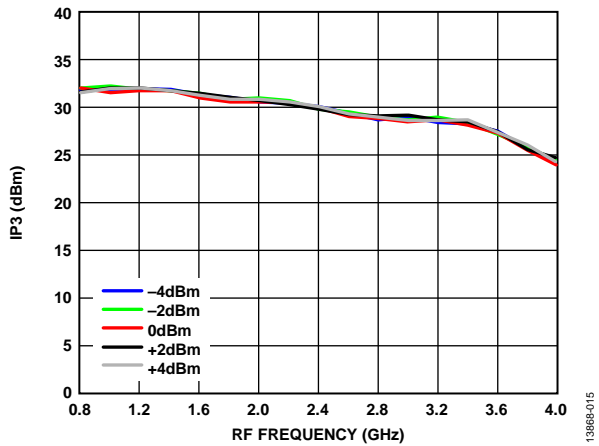

Figure 16. Output IP3 vs. RF Frequency at Various LO Powers

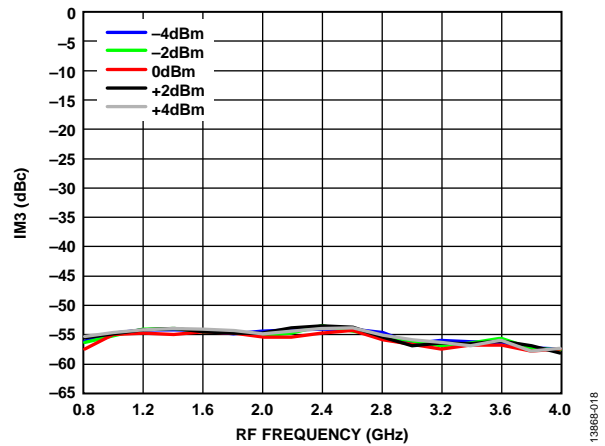

Figure 19. IM3 vs. RF Frequency at Various LO Powers

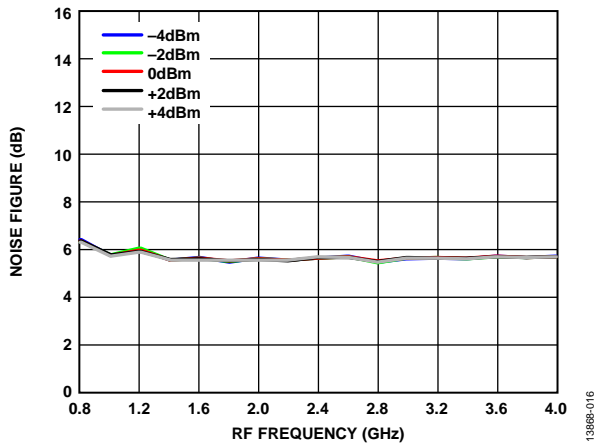

Figure 17. Noise Figure vs. RF Frequency at Various LO Powers

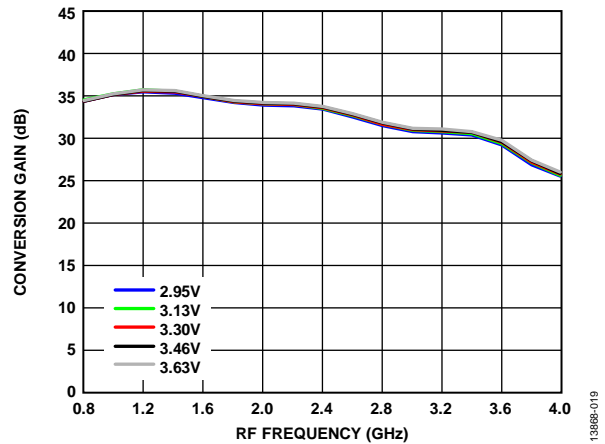

Figure 20. Conversion Gain vs. RF Frequency at Various V_{CCx}

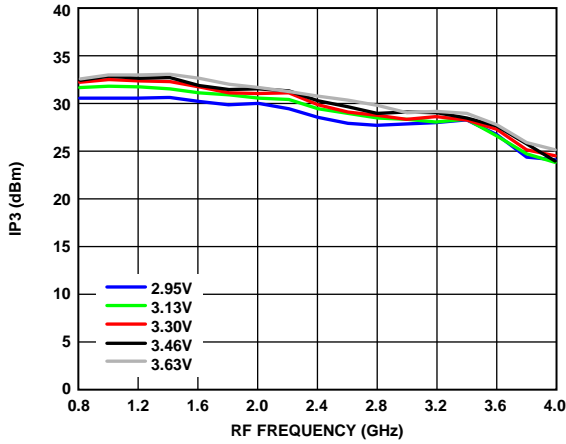

Figure 21. Output IP3 vs. RF Frequency at Various V_{CCX}

13986-020

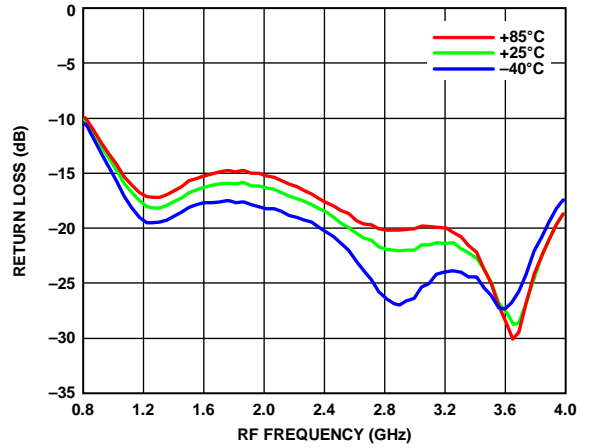

Figure 24. RF Return Loss vs. RF Frequency over Temperature

13986-023

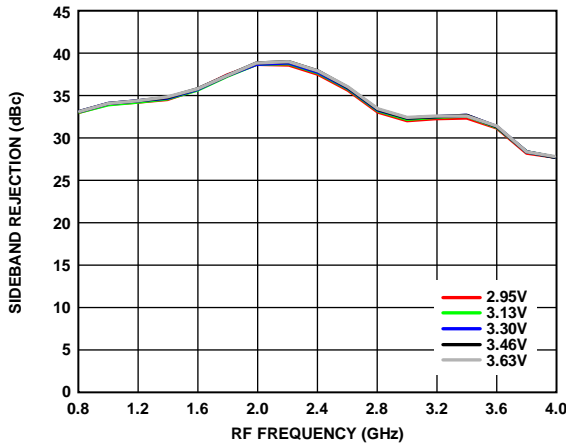

Figure 22. Sideband Rejection vs. RF Frequency at Various V_{CCX}

13986-021

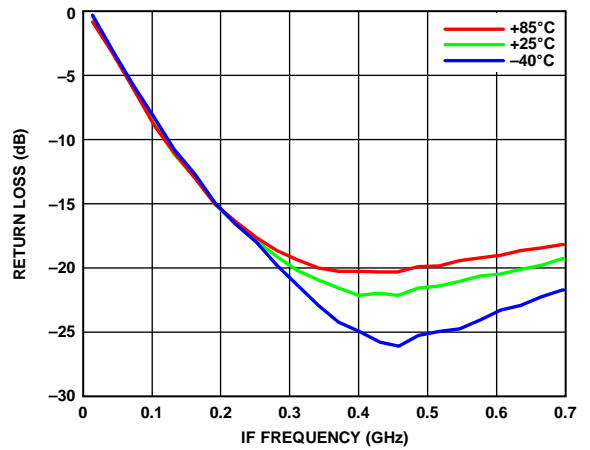

Figure 25. IF Return Loss vs. RF Frequency over Temperature

13986-024

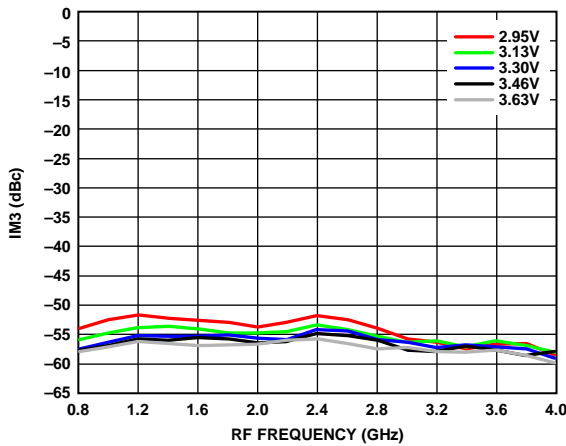

Figure 23. IM3 vs. RF Frequency at Various V_{CCX}

13986-022

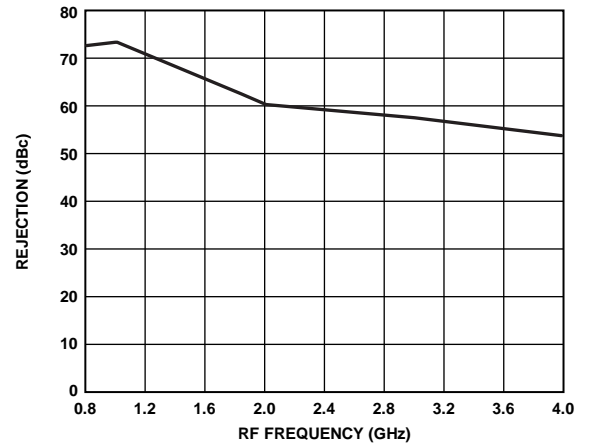

Figure 26. IF to RF Rejection vs. RF Frequency at 25°C

13986-025

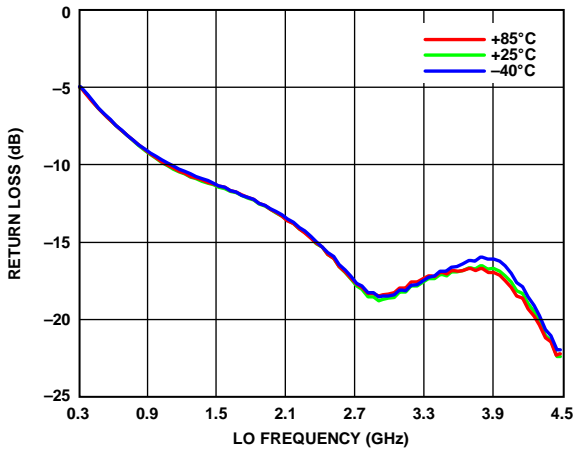

Figure 27. LO Return Loss vs. RF Frequency over Temperature

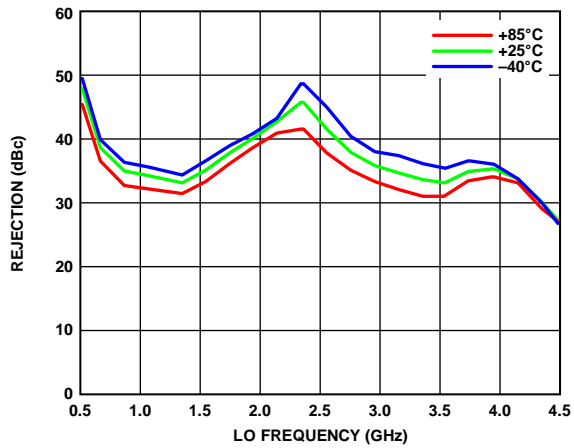

Figure 28. LO to RF Rejection vs. LO Frequency over Temperature, Measurement Uncalibrated for LO Leakage

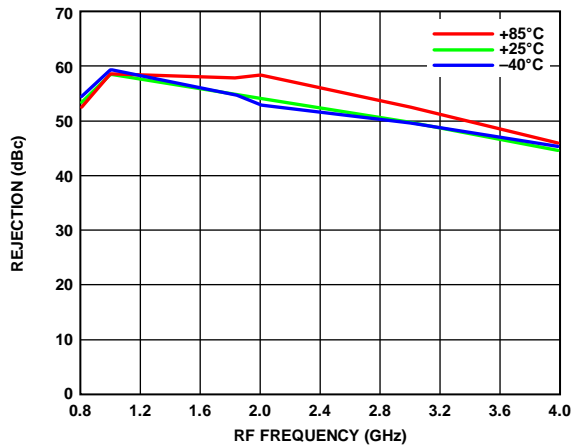

Figure 29. IF to RF Rejection vs. RF Frequency over Temperature, Measured at the Input of the External Low-Pass Filter After C55, see Figure 64

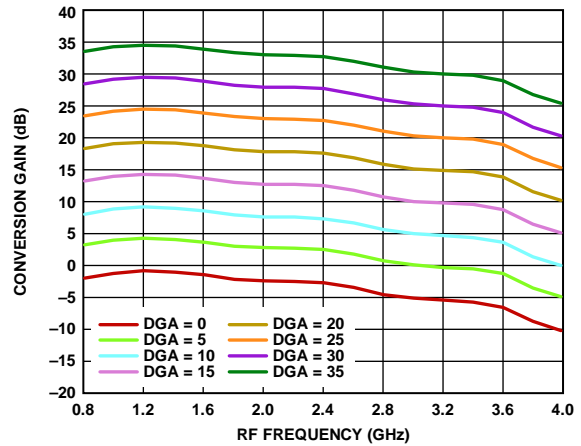

Figure 30. Conversion Gain vs. RF Frequency over DGA Word, Measurement Conducted with VCC_VGA = 3.3 V (Maximum Gain) on RF VGA

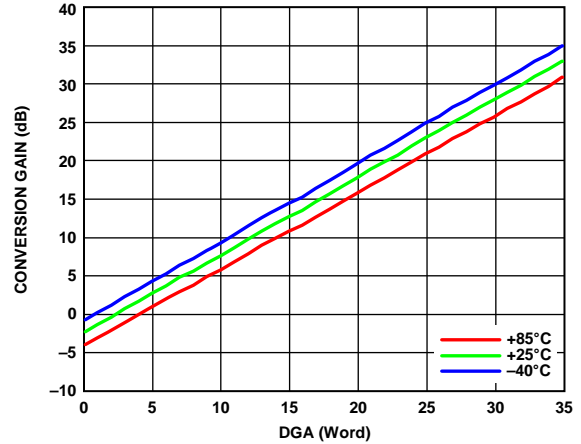

Figure 31. Conversion Gain vs. DGA Word over Temperature, Measurement Conducted with VCC_VGA = 3.3 V (Maximum Gain) on RF VGA, RF = 2 GHz

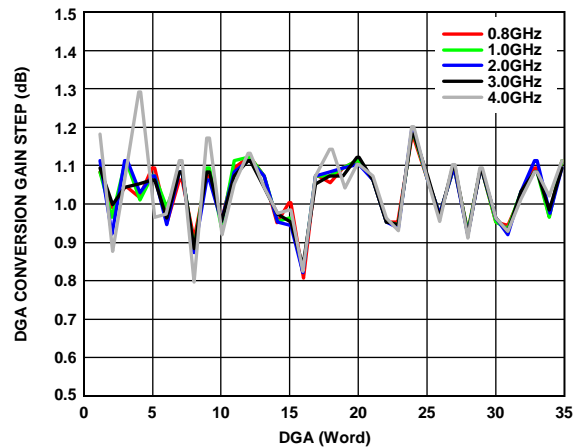

Figure 32. Conversion Gain Step vs. DGA Word over RF Frequency

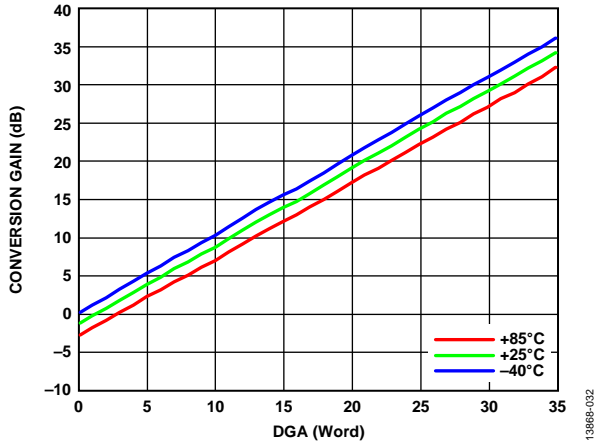

Figure 33. Conversion Gain vs. DGA Word over Temperature, RF = 1 GHz, Measurement Conducted with VCC_VGA = 3.3 V (Maximum Gain) on RF VGA

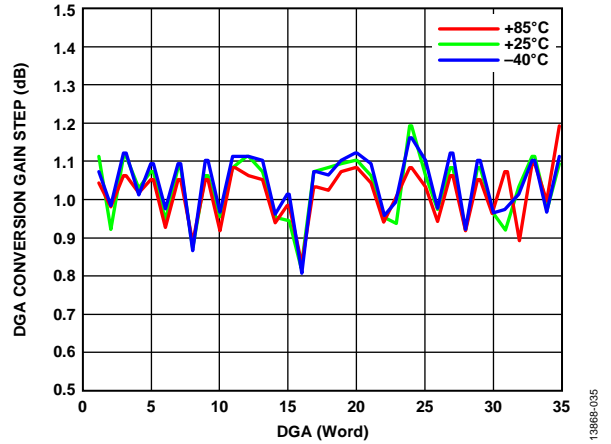

Figure 36. Conversion Gain Step vs. DGA Word over Temperature, RF = 2 GHz

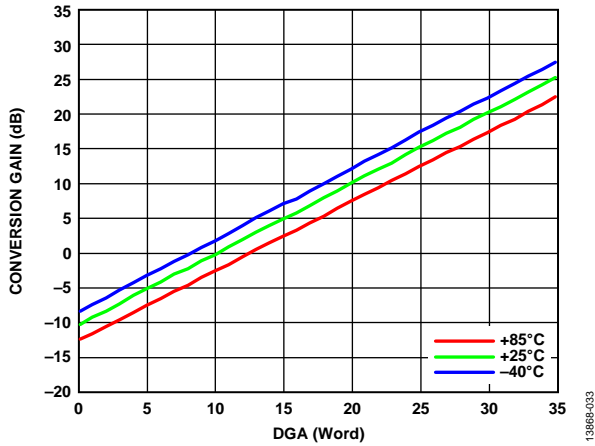

Figure 34. Conversion Gain vs. DGA Word over Temperature, RF = 4 GHz, Measurement Conducted with VCC_VGA = 3.3 V (Maximum Gain) on RF VGA

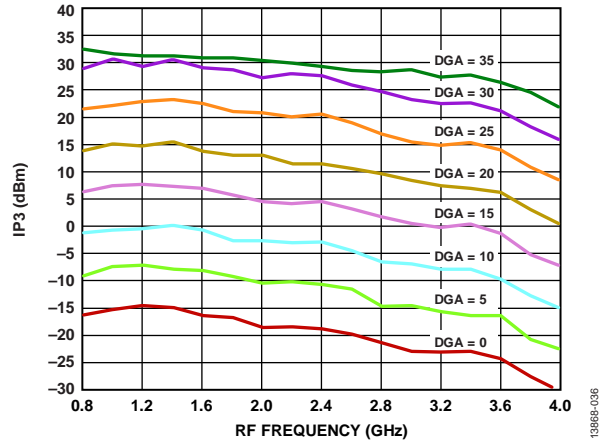

Figure 37. Output IP3 vs. RF Frequency over DGA Word, Measurement Conducted with VCC_VGA = 3.3 V (Maximum Gain) on RF VGA

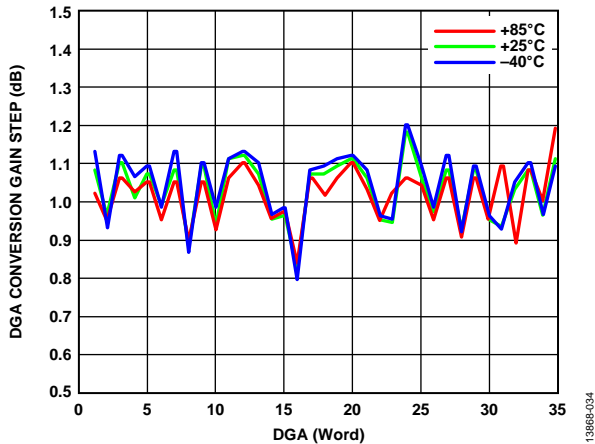

Figure 35. Conversion Gain Step vs. DGA Word over Temperature, RF = 1 GHz, Measurement Conducted with VCC_VGA = 3.3 V (Maximum Gain) on RF VGA

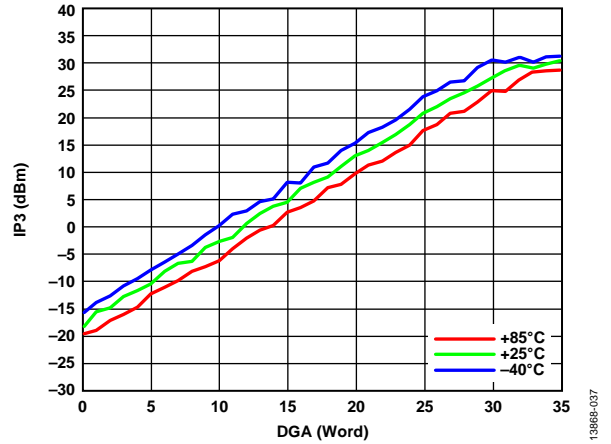

Figure 38. Output IP3 vs. DGA Word over Temperature, RF = 2 GHz, Measurement Conducted with VCC_VGA = 3.3 V (Maximum Gain) on RF VGA

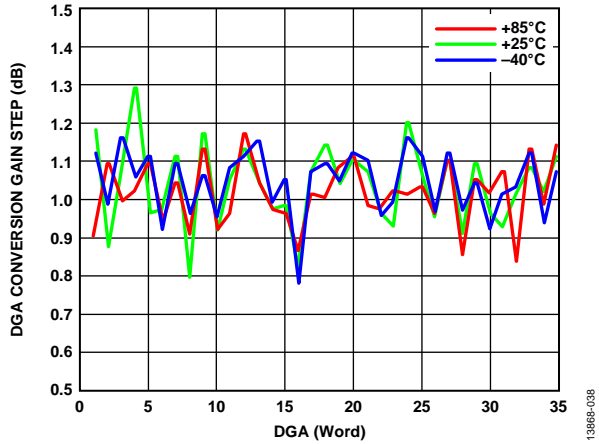

Figure 39. Conversion Gain Step vs. DGA Word over Temperature, RF = 4 GHz

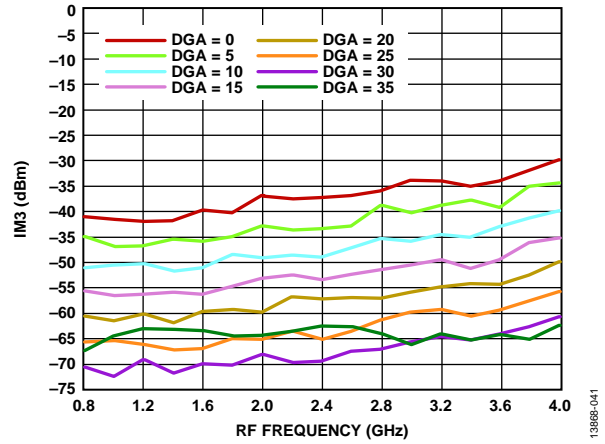

Figure 42. IM3 vs. RF Frequency over DGA Word, Measurement Conducted with VCC_VGA = 3.3 V (Maximum Gain) on RF VGA

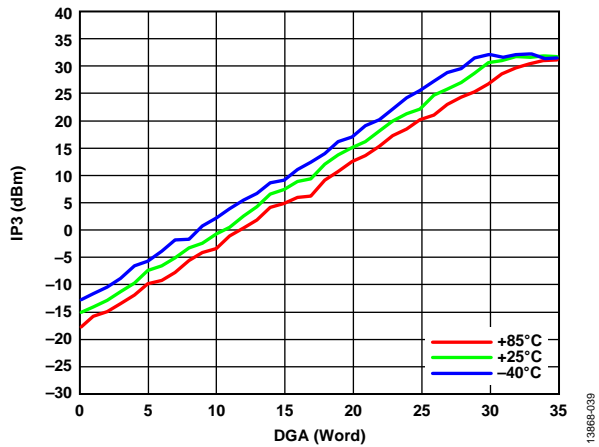

Figure 40. Output IP3 vs. DGA Word over Temperature, RF = 1 GHz, Measurement Conducted with VCC_VGA = 3.3 V (Maximum Gain) on RF VGA

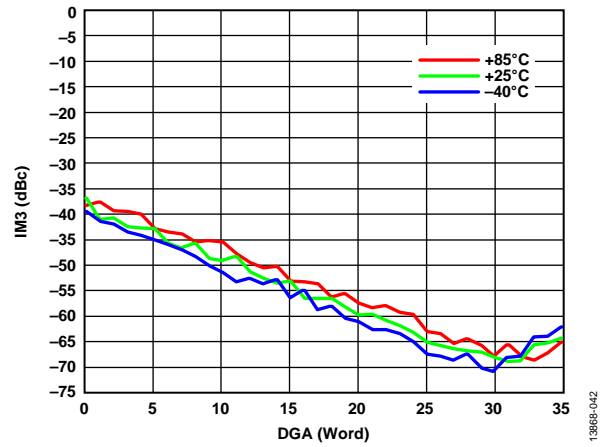

Figure 43. IM3 vs. DGA Word over Temperature, RF = 2 GHz, Measurement Conducted with VCC_VGA = 3.3 V (Maximum Gain) on RF VGA

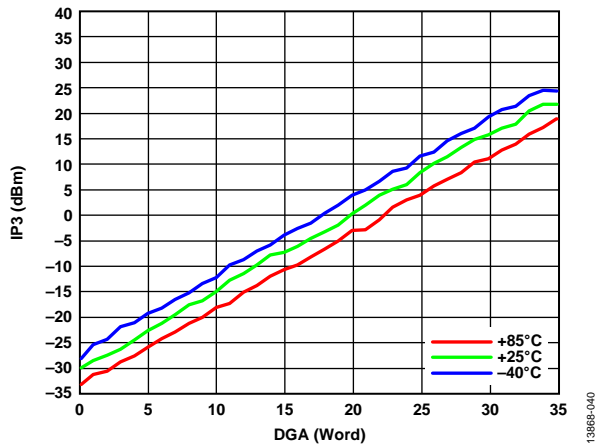

Figure 41. Output IP3 vs. DGA Word over Temperature, RF = 4 GHz, Measurement Conducted with VCC_VGA = 3.3 V (Maximum Gain) on RF VGA

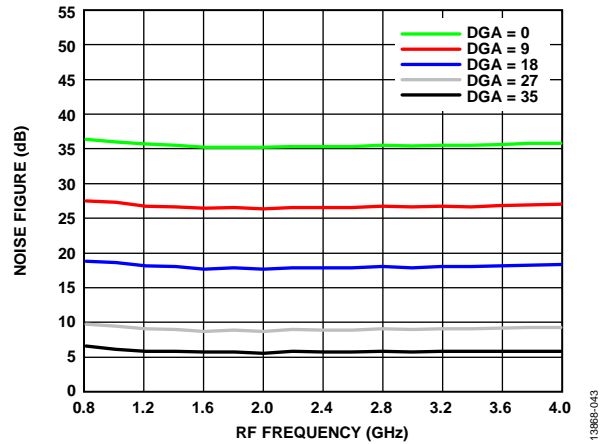

Figure 44. Noise Figure vs. RF Frequency over DGA Word at VCC_VGA = 3.3 V

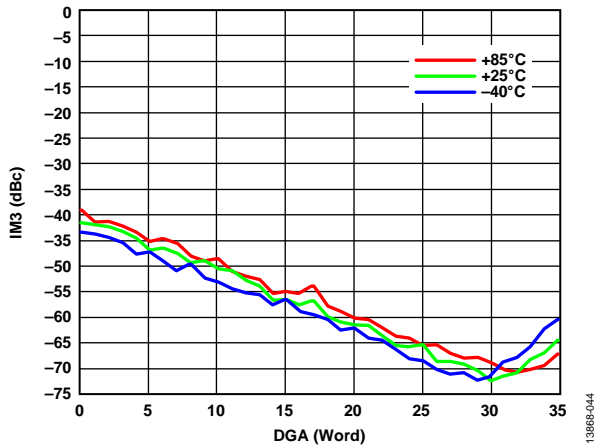

Figure 45. IM3 vs. DGA Word over Temperature, RF = 1 GHz, Measurement Conducted with VCC_VGA = 3.3 V (Maximum Gain) on RF VGA

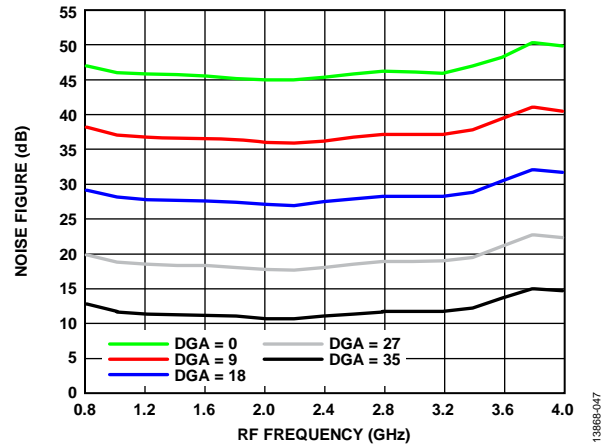

Figure 48. Noise Figure vs. RF Frequency over DGA Word at VCC_VGA = 0 V

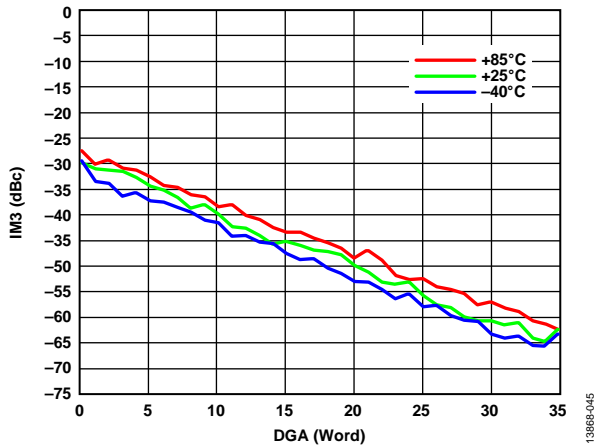

Figure 46. IM3 vs. DGA Word over Temperature, RF = 4 GHz, Measurement Conducted with VCC_VGA = 3.3 V (Maximum Gain) on RF VGA

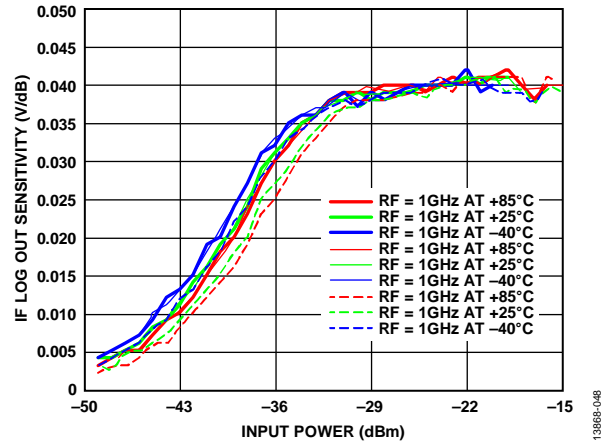

Figure 49. Log IF Detector Sensitivity vs. Input Power over Temperature and RF Frequency

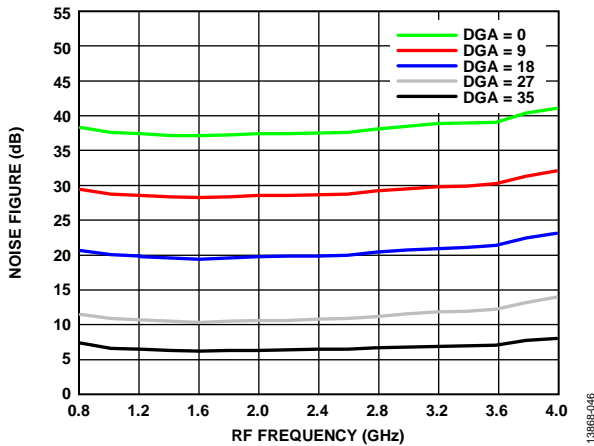

Figure 47. Noise Figure vs. RF Frequency over DGA Word at VCC_VGA = 1.5 V

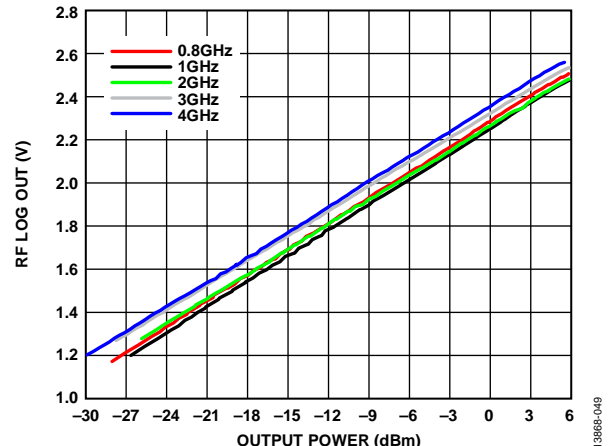

Figure 50. Log RF Detector vs. Output Power over RF Frequency

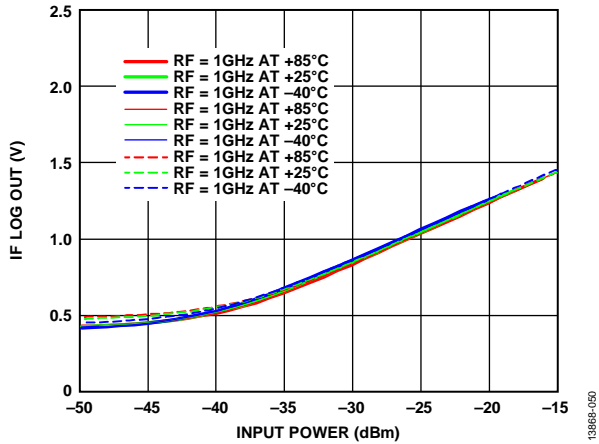

Figure 51. Log IF Detector Output vs. Input Power over Temperature and RF Frequency

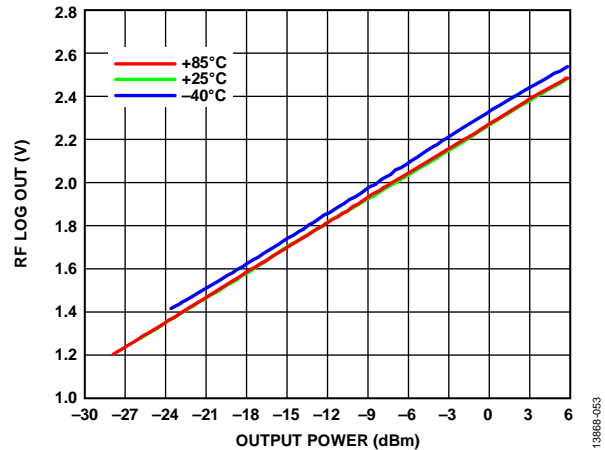

Figure 54. Log RF Detector vs. Output Power over Temperature, RF = 2 GHz

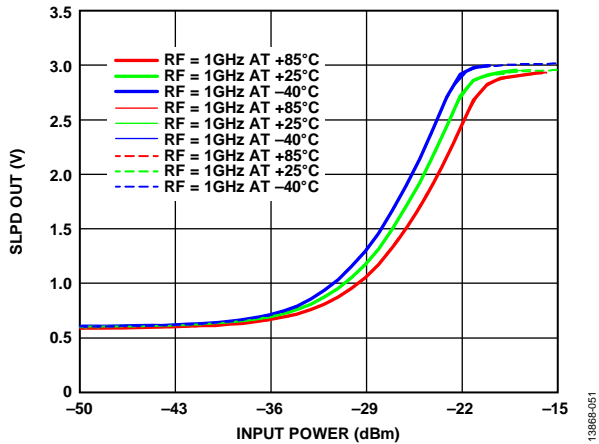

Figure 52. Square Law Detector Output vs. Input Power over Temperature and RF Frequency

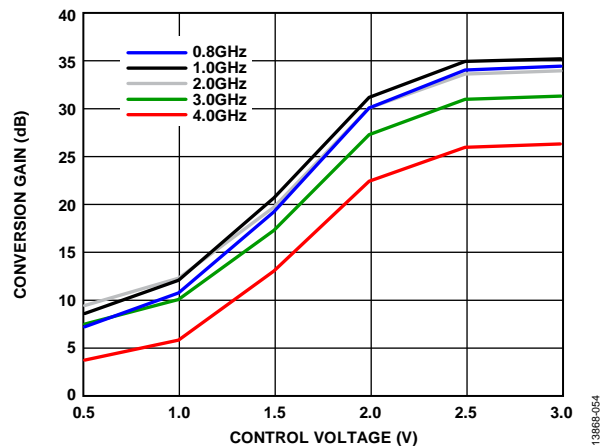

Figure 55. Conversion Gain vs. VGA Control Voltage over RF Frequency, Measurement Conducted with DGA = 35 (Maximum Gain) on IF DGA

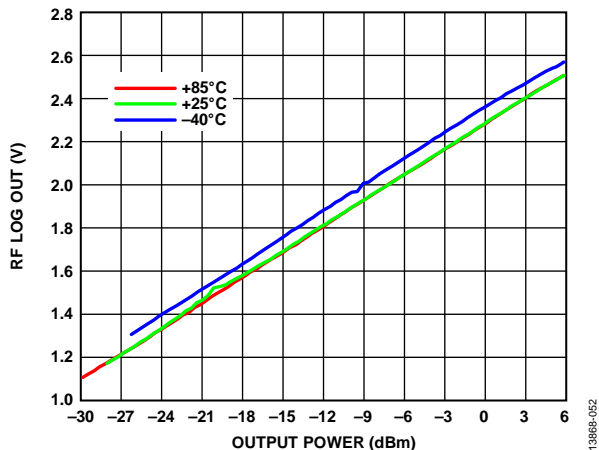

Figure 53. Log RF Detector vs. Output Power over Temperature, RF = 0.8 GHz

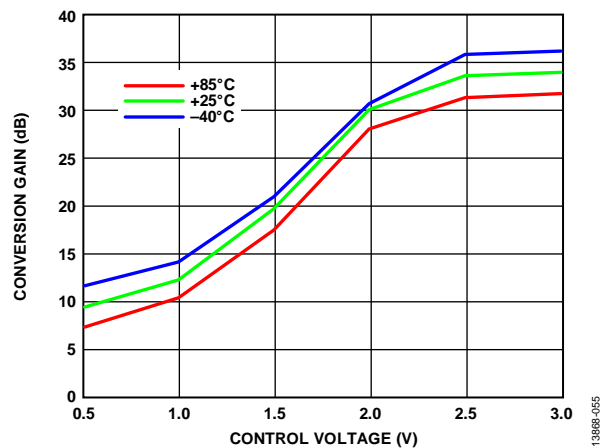

Figure 56. Conversion Gain vs. VGA Control Voltage over Temperature, RF = 2 GHz, Measurement Conducted with DGA = 35 (Maximum Gain) on IF DGA

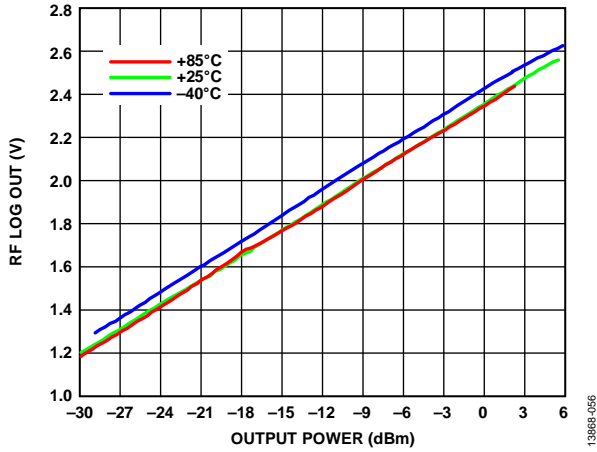

Figure 57. Log RF Detector vs. Output Power over Temperature, RF = 4 GHz

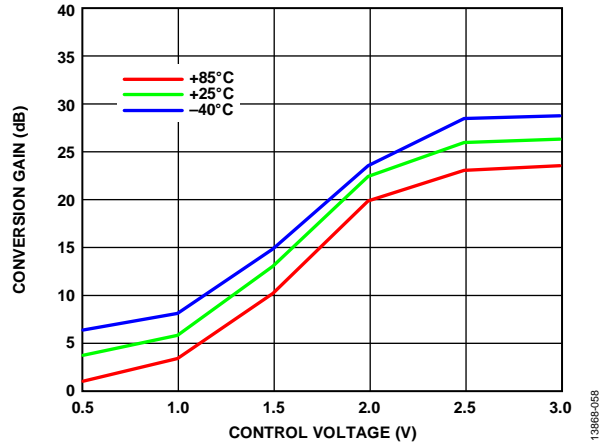

Figure 59. Conversion Gain vs. VGA Control Voltage over Temperature, RF = 4 GHz, Measurement Conducted with DGA = 35 (Maximum Gain) on IF DGA

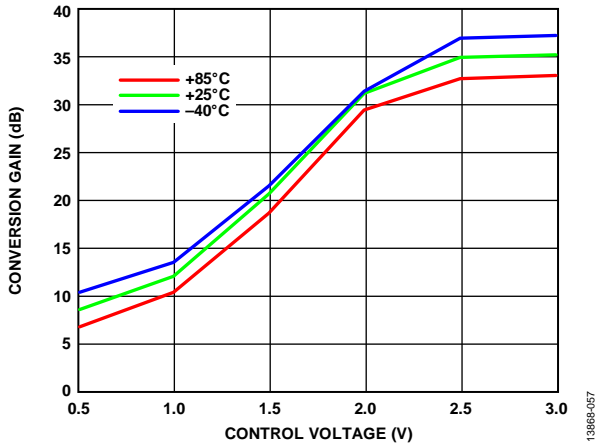

Figure 58. Conversion Gain vs. VGA Control Voltage over Temperature, RF = 1 GHz, Measurement Conducted with DGA = 35 (Maximum Gain) on IF DGA

THEORY OF OPERATION

The **HMC8200LP5ME** is a highly integrated intermediate frequency (IF) transceiver chip that converts intermediate frequency to a single-ended radio frequency (RF) signal at its output. The intermediate frequency (IF) can be supplied to the **HMC8200LP5ME** single ended or through the baseband differential inputs.

The single-ended input of the **HMC8200LP5ME** utilizes an input digital gain amplifier (DGA) that is controlled via SPI, which feeds the IF signals to an image reject mixer. At the input of the device before the DGA, an intermediate log power detector can be used to monitor input power levels into the device. A square law detector follows the DGA to monitor the power entering the mixer. See the Register Array Assignments and Serial Interface section for more information regarding the DGA.

The baseband differential inputs of the **HMC8200LP5ME** feed the intermediate frequency directly into the image reject mixer. It is recommended that when using the single-ended input, do not leave the baseband differential inputs connected. The local oscillator port can either be driven single ended through LO_N or differentially through the combination of LO_N and LO_P. If Driving the local oscillator port differentially improves the LO to RF rejection.

The IF is then converted to RF, which is followed by an amplifier. Next, the amplified RF signal is fed off chip to a low-pass filter. The external filter path feeds back into a variable gain amplifier (VGA) that is voltage controlled. The output of the VGA drives a final amplifier that is the output of the device. An RF log detector is connected to the output of the final amplifier to monitor the output power of the **HMC8200LP5ME**.

The **HMC8200LP5ME** utilizes an input low noise amplifier (LNA) cascaded with a VGA, which can either be controlled by the internal AGC or external voltages, that feeds the RF signals to an image reject mixer. The local oscillator port can either be driven single ended through LO_N or differentially through the combination of LO_N and LO_P.

The radio frequency is then converted to intermediate frequencies, which can either feed off chip via baseband differential outputs or feed on chip into a programmable band-pass filter. It is recommended during IF mode operation that the baseband outputs be unconnected.

The programmable band-pass filter on chip has four programmable bandwidths (14 MHz, 28 MHz, 56 MHz, and 112 MHz). The programmable band-pass filter has the capability to adjust the center frequency.

From the factory, a filter calibration is conducted and the center frequency of the filter is set to 140 MHz. This calibration can be recalled via SPI control or the customer can adjust the center

frequency, but the calibration value must be stored off chip (see the Register Array Assignments section). An external filter option can be utilized to allow the customer to select other filter bandwidths/responses that are not available on chip. The external filter path coming from the image reject mixer feeds into an amplifier that has differential outputs. The output of the external filter can be fed back into the chip, which is then connected to another amplifier.

A VGA follows immediately after the band-pass filter. Control the IF VGA either by the AGC or external voltages. The output of the variable gain amplifier is the output of the device.

REGISTER ARRAY ASSIGNMENTS AND SERIAL INTERFACE

The register arrays for the **HMC8200LP5ME** are organized into seven registers of 16 bits. Using the serial interface, the arrays are written or read one row at a time, as shown in Figure 61 and Figure 62. Figure 61 shows the sequence of signals on the enable (SEN), CLK, and data (SDI) lines to write one 16-bit array of data to a single register. The enable line goes low, the first of 24 data bits is placed on the data line, and the data is sampled on the rising edge of the clock. The data line should remain stable for at least 2 ns after the rising edge of CLK. The device supports a serial interface running up to 10 MHz, the interface is 3.3 V CMOS logic.

A write operation requires 24 data bits and 24 clock pulses, as shown in Figure 61. The 24 data bits contain the 3-bit chip address, followed by the 5-bit register array number, and finally the 16-bit register data. After the 24th clock pulses of the write operation, the enable line returns high to load the register array on the IC.

A read operation requires 24 data bits and 48 clock pulses, as shown in Figure 62. For every register read operation, a write to Register 7 is required first. The data written should contain the 3-bit chip address, followed by the 5-bit register number for Register 7, and finally the 5-bit number of the register to be read. The remaining 11 bits should be logic zeroes. When the read operation is initiated, the data is available on the data output (SDO) pin.

Read Example

If reading Register 2, write the following 24 bits to initiate the read operation.

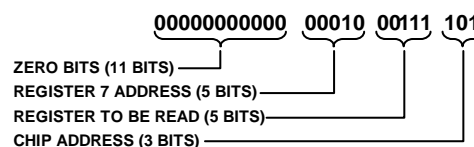

Figure 60. Sample Bits to Initiate Read

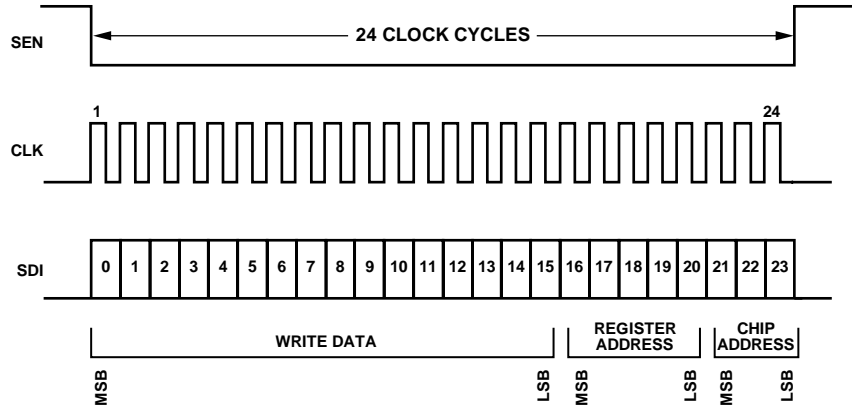

Figure 61. Timing Diagram, SPI Register Write

1386B-060

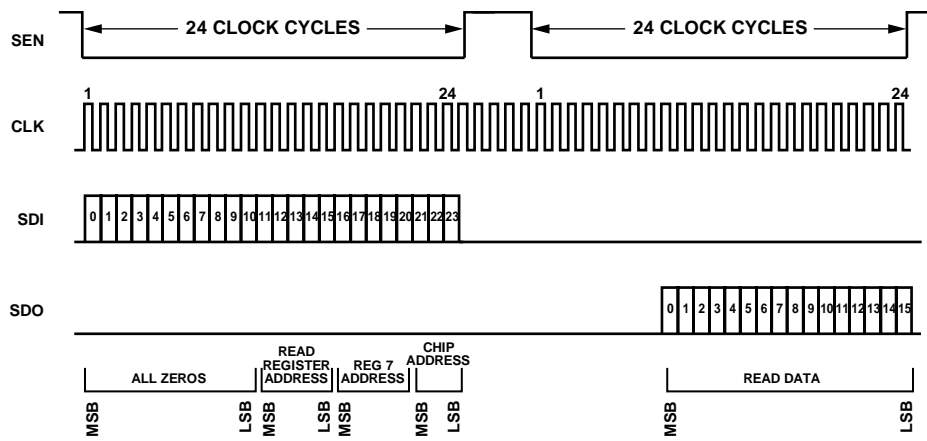

Figure 62. Timing Diagram, SPI Register Read

1386B-061

REGISTER DESCRIPTIONS

REGISTER ARRAY ASSIGNMENTS

In the Access columns (Table 6 through Table 12), R means read, W means write, and R/W means read/write.

Enable Bits

Table 6. Enable Register, (Address 0x01)

Bit No.	Bit Name	Description	Reset	Access
[15:13]	Reserved	Not used	0x6	R/W
12	LOG_IF_EN	Log intermediate frequency (IF) detector enable 0 = disable 1 = enable	0x1	R/W
11	D2SE_EN	Differential to single (after mixer) enable 0 = disable 1 = enable	0x1	R/W
10	Factory diagnostics	0 = Logic 0 for normal operation	0x0	R/W
9	CM_BUFFER_EN	Common-mode buffer enable 0 = disable 1 = enable	0x0	R/W
8	Factory Diagnostics	1 = Logic 1 for normal operation	0x1	R/W
7	LOG_DET_EN	Log detector enable 0 = disable 1 = enable	0x1	R/W
6	MS_EN	Square detector enable 0 = disable 1 = enable	0x1	R/W
5	ENVELOPE_EN	Envelope detector enable 0 = enable 1 = disable	0x1	R/W
4	VGA_EN	Variable gain amplifier (VGA) enable 0 = disable 1 = enable	0x1	R/W
3	IRM_EN	Image reject mixer enable 0 = disable 1 = enable	0x1	R/W
2	IRM_IQ_EN	IQ line enable 0 = disable 1 = enable	0x0	R/W
1	DGA_EN	Digital gain amplifier (DGA) enable 0 = disable 1 = enable	0x1	R/W
0	LPF_EN	Low-pass filter enable 0 = disable 1 = enable	0x0	R/W

Digital Gain Amplifier: DGA Control

Table 7. Digital Gain Amplifier (Address 0x03)

Bit No.	Bit Name	Description	Reset	Access
15	Reserved	Not used	0x0	R/W
[14:9]	DGA_CTRL	Override SPI FIL2_FRQ_SET and use 8-bit word from OTP 0 = minimum gain 1 = ... 100011 = maximum gain	0x0	R/W
[8:0]	Reserved	Not used	0x0	R/W

Digital Gain Amplifier: Amplifier Current, Envelope Level, and VGA Attenuation Bias

Table 8. Digital Gain Amplifier, (Address 0x04)

Bit No.	Bit Name	Description	Reset	Access
[15:9]	Reserved	Not used	0000111	R/W
[8:7]	AMP_CUR	Amplifier current	11	R/W
[6:2]	ENV_LVL	Envelope level	11100	R/W
[1:0]	VGA_ATT_BIAS	VGA attenuation bias	10	R/W

Image Reject Mixer: Sideband, and Polarity and Offset for I

Table 9. Image Reject Mixer Register, (Address 0x05)

Bit No.	Bit Name	Description	Reset	Access
[15:12]	Reserved	Reserved Logic 0010 for normal operation	0010	
11	IRM_IS	Image sideband 0 = upper sideband 1 = lower sideband	1	R/W
[10:9]	Reserved	Reserved Logic 01 for normal operation	01	R/W
8	OFFSET_POLARITY_I	Offset Polarity I	0	R/W
[7:0]	IRM_OFFSET_I	Image reject mixer offset for I	0x0	R/W

Image Reject Mixer: Polarity and Offset for Q

Table 10. Image Reject Mixer Register, (Address 0x06)

Bit No.	Bit Name	Description	Reset	Access
[15:9]	Reserved	Not used	1111000	R/W
8	OFFSET_POLARITY_Q	Offset Polarity Q	0	R/W
[7:0]	IRM_OFFSET_Q	Image reject mixer offset for Q	0x0	R/W

Phase I: Adjust

Table 11. Phase I Register, (Address 0x08)

Bit No.	Bit Name	Description	Reset	Access
[15:9]	Reserved	Not used	1111000	R/W
[8:0]	I_PHASE_ADJ	I phase adjust	0x0	R/W

Phase Q: Adjust

Table 12. Phase Q Register, (Address 0x09)

Bit No.	Bit Name	Description	Reset	Access
[15:9]	Reserved	Not used	1111000	R/W
[8:0]	Q_PHASE_ADJ	Q phase adjust	0x0	R/W

EVALUATION PRINTED CIRCUIT BOARD (PCB)

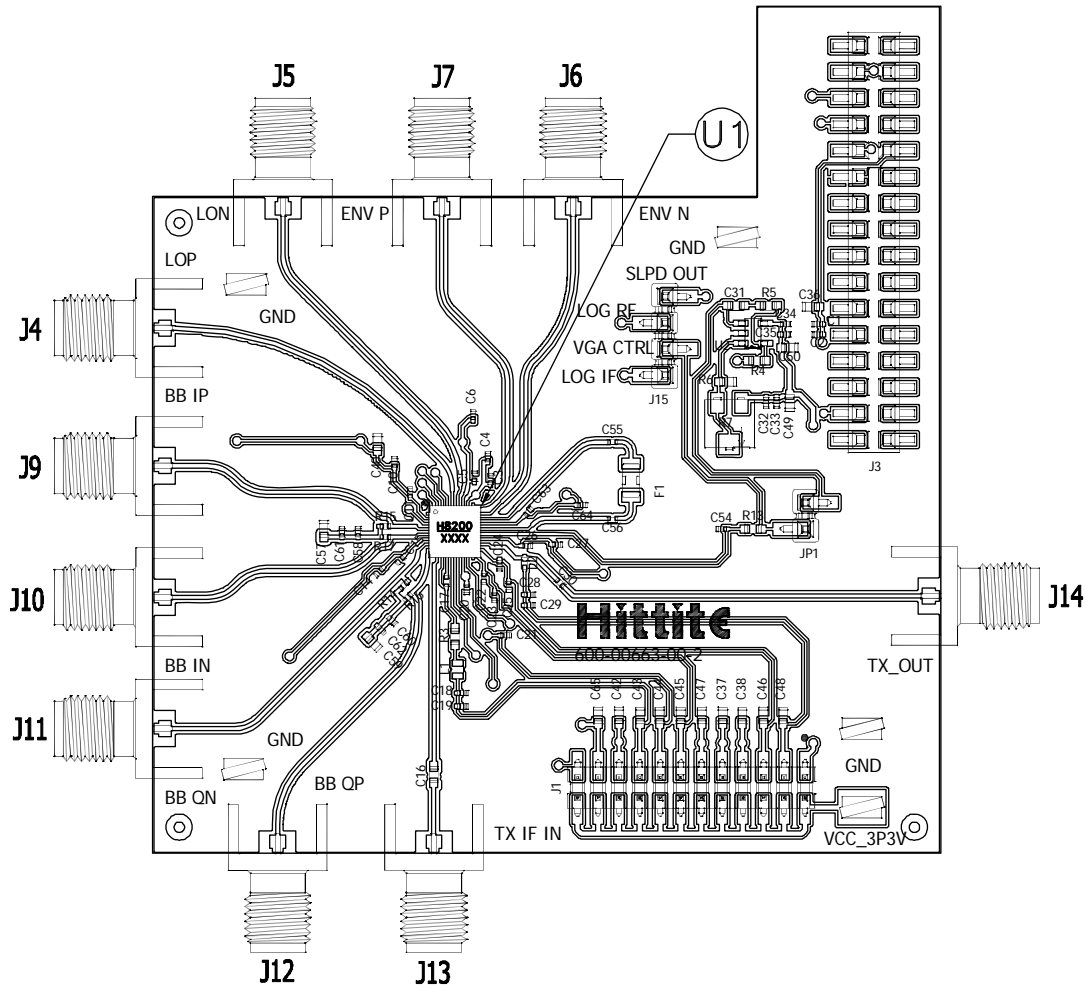

Figure 63. Evaluation PCB

13889-063

EVALUATION PCB SCHEMATIC

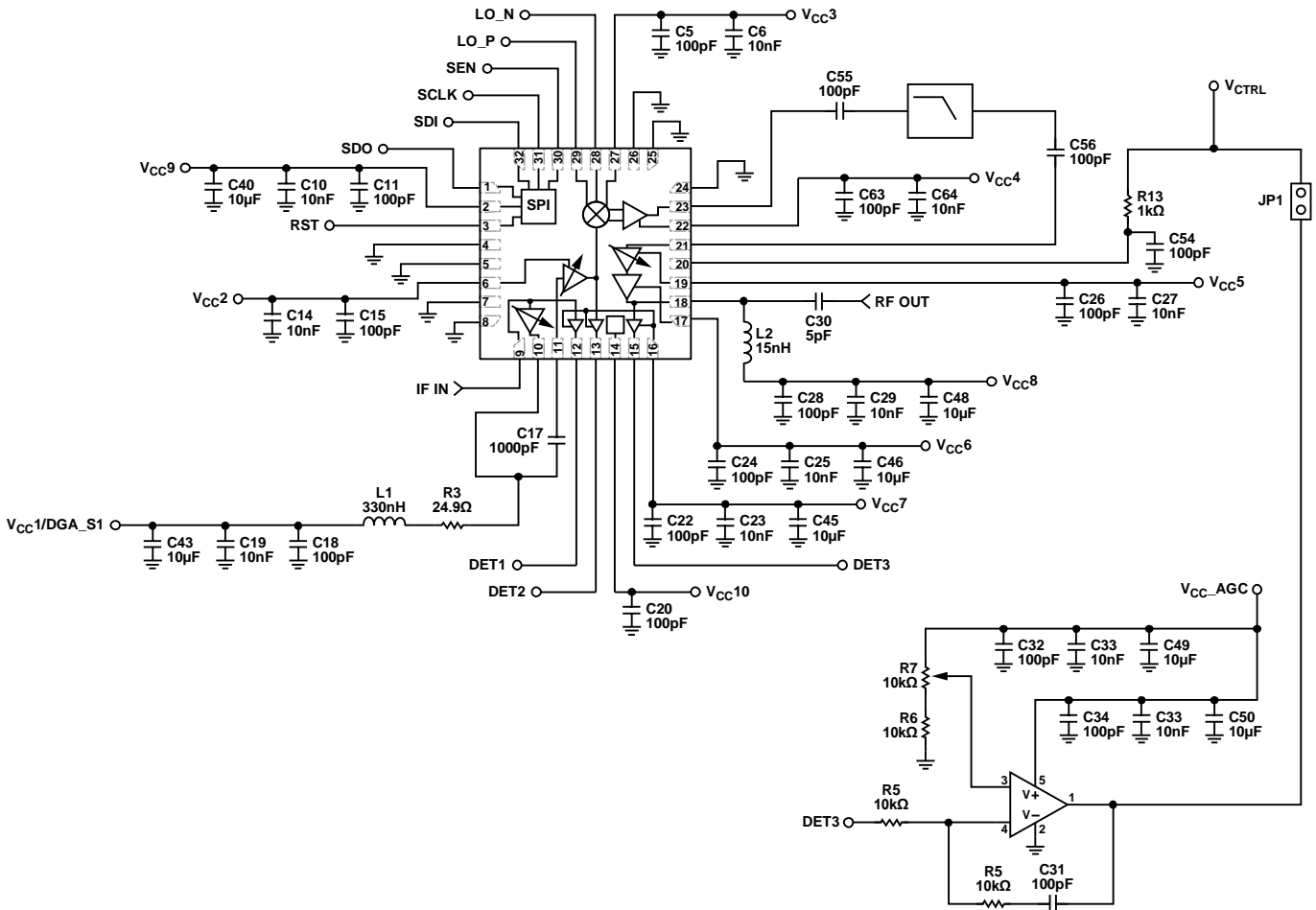
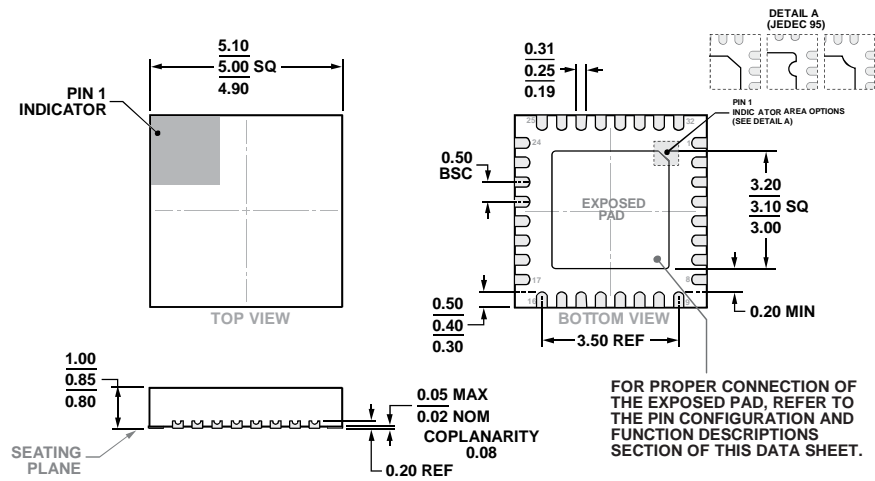

Figure 64. PCB Schematic/Typical Applications Circuit

13869-062

OUTLINE DIMENSIONS



COMPLIANT TO JEDEC STANDARDS MO-220-VHHD-2

Figure 65. 32-Lead Lead Frame Chip Scale Package [LFCSP]
5 mm × 5 mm Body, 0.85 mm Package Height
(CP-32-27)

Dimensions shown in millimeters

ORDERING GUIDE

Model ^{1,2}	Temperature Range	MSL Rating ³	Package Description	Package Option	Branding ⁴	Quantity
HMC8200LP5ME	-40°C to +85°C	MSL3	32-Lead LFCSP, Tape and Reel	CP-32-27	H8200 XXXX	50
HMC8200LP5METR	-40°C to +85°C	MSL3	32-Lead LFCSP, Tape and Reel	CP-32-27	H8200 XXXX	500
EK1HMC8200LP5M			Evaluation Kit			

¹ All products listed in the ordering guide are RoHS compliant.

² The HMC8200LP5ME lead finish is NiPdAu.

³ See the Absolute Maximum Ratings section.

⁴ XXXX is the 4-digit lot number.