



Is Now Part of



**ON Semiconductor®**

To learn more about ON Semiconductor, please visit our website at  
[www.onsemi.com](http://www.onsemi.com)

ON Semiconductor and the ON Semiconductor logo are trademarks of Semiconductor Components Industries, LLC dba ON Semiconductor or its subsidiaries in the United States and/or other countries. ON Semiconductor owns the rights to a number of patents, trademarks, copyrights, trade secrets, and other intellectual property. A listing of ON Semiconductor's product/patent coverage may be accessed at [www.onsemi.com/site/pdf/Patent-Marking.pdf](http://www.onsemi.com/site/pdf/Patent-Marking.pdf). ON Semiconductor reserves the right to make changes without further notice to any products herein. ON Semiconductor makes no warranty, representation or guarantee regarding the suitability of its products for any particular purpose, nor does ON Semiconductor assume any liability arising out of the application or use of any product or circuit, and specifically disclaims any and all liability, including without limitation special, consequential or incidental damages. Buyer is responsible for its products and applications using ON Semiconductor products, including compliance with all laws, regulations and safety requirements or standards, regardless of any support or applications information provided by ON Semiconductor. "Typical" parameters which may be provided in ON Semiconductor data sheets and/or specifications can and do vary in different applications and actual performance may vary over time. All operating parameters, including "Typicals" must be validated for each customer application by customer's technical experts. ON Semiconductor does not convey any license under its patent rights nor the rights of others. ON Semiconductor products are not designed, intended, or authorized for use as a critical component in life support systems or any FDA Class 3 medical devices or medical devices with a same or similar classification in a foreign jurisdiction or any devices intended for implantation in the human body. Should Buyer purchase or use ON Semiconductor products for any such unintended or unauthorized application, Buyer shall indemnify and hold ON Semiconductor and its officers, employees, subsidiaries, affiliates, and distributors harmless against all claims, costs, damages, and expenses, and reasonable attorney fees arising out of, directly or indirectly, any claim of personal injury or death associated with such unintended or unauthorized use, even if such claim alleges that ON Semiconductor was negligent regarding the design or manufacture of the part. ON Semiconductor is an Equal Opportunity/Affirmative Action Employer. This literature is subject to all applicable copyright laws and is not for resale in any manner.

# USB1T11A — Universal Serial Bus Transceiver

## Features

- Complies with Universal Serial Bus Specification 1.1
- Utilizes Digital Inputs and Outputs to Transmit and Receive USB Cable Data
- Supports 12Mbit/s “Full Speed” and 1.5Mbit/s “Low Speed” Serial Data Transmission
- Compatible with the VHDL “Serial Interface Engine” from USB Implementers’ Forum
- Supports Single-ended Data Interface
- Single 3.3V Supply
- ESD Performance: Human Body Model  
>9.5kV on D-, D+ pins only  
>4kV on all other pins

## Description

The USB1T11A is a one-chip, generic USB transceiver. It is designed to allow 5.0V or 3.3V programmable and standard logic to interface with the physical layer of the Universal Serial Bus. It is capable of transmitting and receiving serial data at both full-speed (12Mbit/s) and low-speed (1.5Mbit/s) data rates.

The input and output signals of the USB1T11A conform with the “Serial Interface Engine.” Implementation of the serial interface engine allows designers to make USB-compatible devices with off-the-shelf logic to modify and update the application.

## Ordering Information

Part Number	Operating Temperature Range	Package	Packing Method
USB1T11AM	-40 to +85°C	14-Lead, Small Outline Integrated Circuit (SOIC), JEDEC MS-012, 0.150-Inch Narrow	Tube
USB1T11AMX		14-Lead, Small Outline Integrated Circuit (SOIC), JEDEC MS-012, 0.150-Inch Narrow	Tape and Reel
USB1T11AMTC		14-Lead, Thin Shrink Small Outline Package (TSSOP), JEDEC MO-153, 4.4mm Wide	Tube
USB1T11AMTCX		14-Lead, Thin Shrink Small Outline Package (TSSOP), JEDEC MO-153, 4.4mm Wide	Tape and Reel

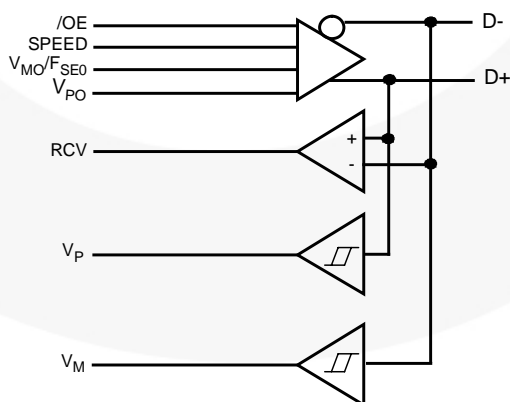

Figure 1. Logic Diagram

## Pin Configuration

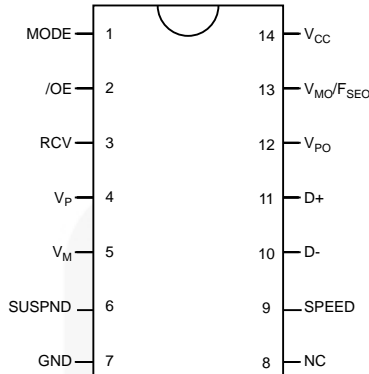

Figure 2. TSSOP and SOIC Pin Assignments

## Pin Descriptions

Pin Names	I/O	Description																																				
RCV	O	<b>Receive Data.</b> CMOS level output for USB differential input.																																				
/OE	I	<b>Output Enable.</b> Active LOW, enables the transceiver to transmit data on the bus. When not active, the transceiver is in receive mode.																																				
Mode	I	<b>Mode.</b> When left unconnected, a weak pull-up transistor pulls it to $V_{CC}$ and, in this GND, the $V_{MO}/F_{SEO}$ pin takes the function of $F_{SEO}$ (force SEO).																																				
$V_{PO}, V_{MO}/F_{SEO}$	I	Inputs to differential driver. (Outputs from SIE.)																																				
		<table border="1"> <thead> <tr> <th>Mode</th> <th><math>V_{PO}</math></th> <th><math>V_{MO}/F_{SEO}</math></th> <th>RESULT</th> </tr> </thead> <tbody> <tr> <td>0</td> <td>0</td> <td>0</td> <td>Logic "0"</td> </tr> <tr> <td>0</td> <td>0</td> <td>1</td> <td>/SEO</td> </tr> <tr> <td>0</td> <td>1</td> <td>0</td> <td>Logic "1"</td> </tr> <tr> <td>0</td> <td>1</td> <td>1</td> <td>/SEO</td> </tr> <tr> <td>1</td> <td>0</td> <td>0</td> <td>/SEO</td> </tr> <tr> <td>1</td> <td>0</td> <td>1</td> <td>Logic "0"</td> </tr> <tr> <td>1</td> <td>1</td> <td>0</td> <td>Logic "1"</td> </tr> <tr> <td>1</td> <td>1</td> <td>1</td> <td>Illegal Code</td> </tr> </tbody> </table>	Mode	$V_{PO}$	$V_{MO}/F_{SEO}$	RESULT	0	0	0	Logic "0"	0	0	1	/SEO	0	1	0	Logic "1"	0	1	1	/SEO	1	0	0	/SEO	1	0	1	Logic "0"	1	1	0	Logic "1"	1	1	1	Illegal Code
		Mode	$V_{PO}$	$V_{MO}/F_{SEO}$	RESULT																																	
		0	0	0	Logic "0"																																	
		0	0	1	/SEO																																	
		0	1	0	Logic "1"																																	
		0	1	1	/SEO																																	
		1	0	0	/SEO																																	
		1	0	1	Logic "0"																																	
1	1	0	Logic "1"																																			
1	1	1	Illegal Code																																			
$V_P, V_M$	O	Buffered version of D- and D+. Outputs are logic "0" and logic "1." Used to detect single ended zero (/SEO), error conditions, and interconnected speed. (Input to SIE).																																				
		<table border="1"> <thead> <tr> <th><math>V_P</math></th> <th><math>V_M</math></th> <th>RESULT</th> </tr> </thead> <tbody> <tr> <td>0</td> <td>0</td> <td>/SEO</td> </tr> <tr> <td>0</td> <td>1</td> <td>Low Speed</td> </tr> <tr> <td>1</td> <td>0</td> <td>Full Speed</td> </tr> <tr> <td>0</td> <td>1</td> <td>Error</td> </tr> </tbody> </table>	$V_P$	$V_M$	RESULT	0	0	/SEO	0	1	Low Speed	1	0	Full Speed	0	1	Error																					
		$V_P$	$V_M$	RESULT																																		
		0	0	/SEO																																		
		0	1	Low Speed																																		
1	0	Full Speed																																				
0	1	Error																																				
D+, D-	AI/O	Data+, Data-. Differential data bus conforming to the Universal Serial Bus standard.																																				
SUSPND	I	<b>Suspend.</b> Enables a low-power state while the USB bus is inactive. While the suspend pin is active, it drives the RCV pin to a logic "0" state. Both D+ and D- are 3-STATE.																																				
Speed	I	<b>Edge Rate Control.</b> Logic "1" operates at edge rates for "full speed." Logic "0" operates edge rates for "low speed."																																				
$V_{CC}$		3.0 to 3.6 power supply.																																				
GND		Ground reference.																																				

### Functional Truth Table

Input					I/O		Outputs			
Mode	V <sub>PO</sub>	V <sub>MO</sub> /F <sub>SEO</sub>	/OE	SUSPND	D+	D-	RCV	V <sub>P</sub>	V <sub>M</sub>	Result
0	0	0	0	0	0	1	0	0	1	Logic "0"
0	0	1	0	0	0	0	Undefined State	0	0	/SEO
0	1	0	0	0	1	0	1	1	0	Logic "1"
0	1	1	0	0	0	0	Undefined State	0	0	/SEO
1	0	0	0	0	0	0	Undefined State	0	0	/SEO
1	0	1	0	0	0	1	0	0	1	Logic "0"
1	1	0	0	0	1	0	1	1	0	Logic "1"
1	1	1	0	0	1	1	Undefined State	Undefined State	Undefined State	Illegal Code
Don't Care	Don't Care	Don't Care	1	0	3-State	3-State	Undefined State	Undefined State	Undefined State	D+/D-Hi-Z
Don't Care	Don't Care	Don't Care	1	1	3-State	3-State	Undefined State	Undefined State	Undefined State	D+/D-Hi-Z

## Absolute Maximum Ratings

Stresses exceeding the absolute maximum ratings may damage the device. The device may not function or be operable above the recommended operating conditions and stressing the parts to these levels is not recommended. In addition, extended exposure to stresses above the recommended operating conditions may affect device reliability. The absolute maximum ratings are stress ratings only.

Symbol	Parameter		Min.	Max.	Unit
$V_{CC}$	DC Supply Voltage		0.5	7.0	V
$I_{IK}$	DC Input Diode Current, $V_{IN} < 0V$			-50	mA
$V_{IN}$	Input Voltage <sup>(1)</sup>		0.5	5.5	V
$V_{I/O}$	Input Voltage		0.5	$V_{CC} + 0.5$	V
$I_{OK}$	Output Diode Current, $V_O > V_{CC}$ or $V_O < 0$			$\pm 50$	mA
$V_O$	Output Voltage		0.5	$V_{CC} + 0.5$	V
$I_O$	Output Source or Sink Current ( $V_O = 0$ to $V_{CC}$ )	$V_P, V_M, RCV$ Pins		$\pm 15$	mA
		D+/D- Pins		$\pm 50$	
$I_{CC} / I_{GND}$	$V_{CC} / GND$ Current			$\pm 100$	mA
$T_{STG}$	Storage Temperature Range		-60	+150	°C

### Note:

- The input and output negative voltage ratings may be exceeded if the input and output diode current ratings are observed.

## Recommended Operating Conditions

The Recommended Operating Conditions table defines the conditions for actual device operation. Recommended operating conditions are specified to ensure optimal performance to the datasheet specifications. Fairchild does not recommend exceeding them or designing to Absolute Maximum Ratings.

Symbol	Parameter	Min.	Max.	Unit
$V_{CC}$	Power Supply Operating	3.0	3.6	V
$V_{IN}$	Input Voltage	0	5.5	V
$V_{AI/O}$	Input Range for AI/O	0	$V_{CC}$	V
$V_O$	Output Voltage	0	$V_{CC}$	V
$T_A$	Operating Ambient Temperature, Free Air	-40	+85	°C

## DC Electrical Characteristics Digital Pins

Over recommended range of supply voltage and operating free air temperature unless otherwise noted.  
 $V_{CC} = 3.0V$  to  $3.6V$ .

Symbol	Parameter	Conditions	$T_A = -40$ to $+85^\circ C$			Units
			Min.	Typ.	Max.	
<b>Input Levels</b>						
$V_{IL}$	Low-Level Input Voltage				0.8	V
$V_{IH}$	High-Level Input Voltage		2			V
<b>Output Levels</b>						
$V_{OL}$	Low-Level Output Voltage	$I_{OL}=4mA$			0.4	V
		$I_{OL}=20\mu A$			0.1	
$V_{OH}$	High-Level Output Voltage	$I_{OH}=4mA$	2.5			V
		$I_{OH}=20\mu A$	$V_{CC}-0.1$			
<b>Leakage Current</b>						
$I_{IN}$	Input Leakage Current	$V_{CC}=3.0$ to $3.6$			$\pm 5$	$\mu A$
$I_{CCFS}$	Supply Current, Full Speed	$V_{CC}=3.0$ to $3.6$			5	mA
$I_{CCLS}$	Supply Current, Low Speed	$V_{CC}=3.0$ to $3.6$			5	mA
$I_{CCQ}$	Quiescent Supply Current	$V_{CC}=3.0$ to $3.6$ , $V_{IN}=V_{CC}$ or GND			5	mA
$I_{CCS}$	Supply Current in Suspend	$V_{CC}=3.0$ to $3.6$ , Mode= $V_{CC}$			10	$\mu A$

## DC Electrical Characteristics D+/D- Pins

Over recommended range of supply voltage and operating free air temperature unless otherwise noted.  
 $V_{CC} = 3.0V$  to  $3.6V$ .

Symbol	Parameter	Conditions	$T_A = -40$ to $+85^\circ C$			Units
			Min.	Typ.	Max.	
<b>Input Levels</b>						
$V_{DI}$	Differential Input Sensitivity	$ (D+) - (D-) $	0.2			V
$V_{CM}$	Differential Common-Mode Range	Includes $V_{DI}$ Range	0.8		2.5	V
$V_{SE}$	Single-Ended Receiver Threshold		0.8		2.0	V
<b>Output Levels</b>						
$V_{OL}$	Static Output Low-Voltage				0.3	V
$V_{OH}$	Static Output High-Voltage	$R_L$ of $1.5k\Omega$ to $3.6V$	2.8		3.6	V
$V_{CR}$	Differential Crossover	$R_L$ of $1.5k\Omega$ to GND	1.3		2.0	V
<b>Leakage Current</b>						
$I_{OZ}$	High Z-State Data Line Leakage Current	$0V < V_{IN} < 3.3V$			$\pm 5$	$\mu A$
<b>Capacitance</b>						
$C_{IN}^{(2)}$	Transceiver Capacitance	Pin to GND			10	pF
	Capacitance Match				10	%
<b>Output Resistance</b>						
$Z_{DRV}^{(3)}$	Driver Output Resistance	Steady-State Drive	4		20	$\Omega$
	Resistance Match				10	%

### Notes:

- This specification is guaranteed by design and statistical process distribution.
- Excludes external resistor. To comply with USB specification 1.1, external series resistors of  $24W \pm 1\%$  each on D+ and D- are recommended.

## AC Electrical Characteristics D+/D- Pins, Full Speed

Over recommended range of supply voltage and operating free air temperature unless otherwise noted.  
 $V_{CC} = 3.0V$  to  $3.6V$ ,  $C_L = 50pF$ ;  $R_L = k\Omega$  on D+ to  $V_{CC}$ .

Symbol	Parameter	Conditions	$T_A = -40$ to $+85^\circ C$			Units
			Min.	Typ.	Max.	
<b>Driver Characteristics</b>						
$t_R, t_F$	Rise and Fall Time	10 and 90%, Figure 4	4		20	ns
$t_{RFM}$	Rise/Fall Time Matching	$t_R / t_F$	90		110	%
$V_{CRS}$	Output Signal Crossover Voltage		1.3		2.0	V
<b>Driver Timings</b>						
$t_{PLH}$	Driver Propagation Delay ( $V_{PO}, V_{MO}/F_{SEO}$ to D+/D-)	Figure 4			18	ns
$t_{PHZ}, t_{PLZ}$	Driver Disable Delay (/OE to D+/D-)	Figure 6			13	ns
$t_{PZH}, t_{PZL}$	Driver Enable Delay (/OE to D+/D-)	Figure 6			17	ns
<b>Receiver Timings</b>						
$t_{PLH}$	Receiver Propagation Delay	Figure 5			16	ns
$t_{PHL}$	D+/D- to RVC	Figure 5			19	ns
$t_{PLH}, t_{PHL}$	Single-ended Receiver Delay (D+/D- to $V_P, V_M$ )	Figure 5			8	ns

## AC Electrical Characteristics D+/D- Pins, Low Speed

Over recommended range of supply voltage and operating free air temperature unless otherwise noted.  
 $V_{CC} = 3.0V$  to  $3.6V$ ,  $C_L = 200pF$  to  $600pF$ ;  $R_L = 1.5k\Omega$  on D- to  $V_{CC}$ .

Symbol	Parameter	Conditions	$T_A = -40$ to $+85^\circ C$			Units
			Min.	Typ.	Max.	
<b>Driver Characteristics</b>						
$t_{LR}, t_{LF}$	Rise and Fall Time	10 and 90%, Figure 4	75		300	ns
$t_{RFM}$	Rise/Fall Time Matching	$t_R / t_F$	80		120	%
$V_{CRS}$	Output Signal Crossover Voltage		1.3		2.0	V
<b>Driver Timings</b>						
$t_{PLH}, t_{PHL}$	Driver Propagation Delay ( $V_{PO}, V_{MO}/F_{SEO}$ to D+/D-)	Figure 4			300	ns
$t_{PHZ}, t_{PLZ}$	Driver Disable Delay (/OE to D+/D-)	Figure 6			13	ns
$t_{PZH}, t_{PZL}$	Driver Enable Delay (/OE to D+/D-)	Figure 6			205	ns
<b>Receiver Timings</b>						
$t_{PLH}, t_{PHL}$	Receiver Propagation Delay (D+/D- to RVC)	Figure 5			18	ns
$t_{PLH}, t_{PHL}$	Single-ended Receiver Delay (D+/D- to $V_P, V_M$ )	Figure 5			28	ns

### AC Loadings and Waveforms

$V_{OL}$  and  $V_{OH}$  are the typical output voltage drops that occur with the output load.  $V_{CC}$  never goes below 3.0V.

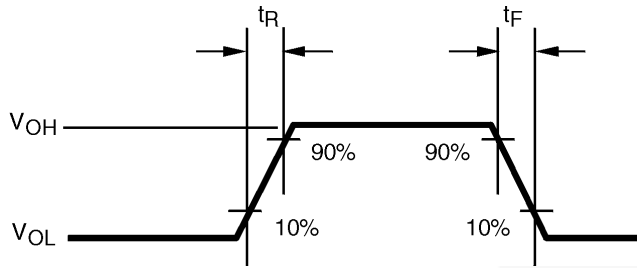

Figure 3. Rise and Fall Times

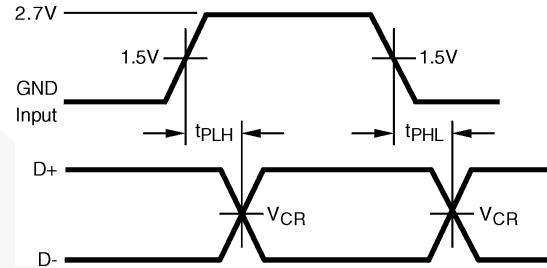

Figure 4.  $V_{PO}$ ,  $V_{MO}/F_{SEO}$  to D+/D-

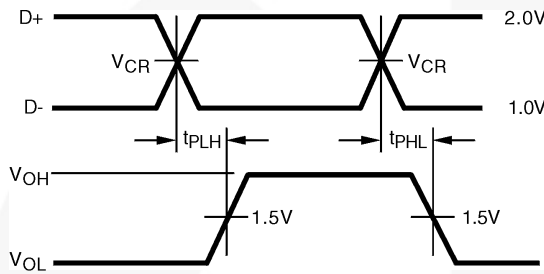

Figure 5. D+/D- to RCV,  $V_P/V_M$

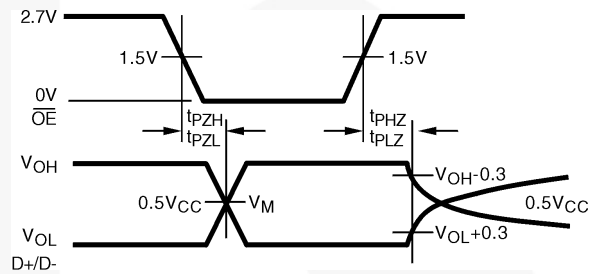

Figure 6. /OE to D+/D-

### Test Circuits and Waveforms

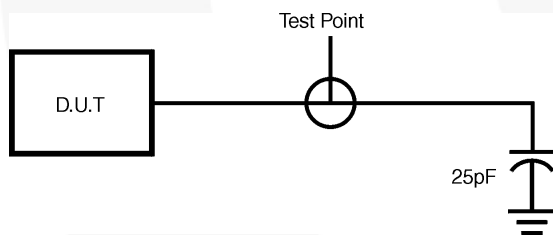

Figure 7. Load for  $V_M/V_P$  and RCV

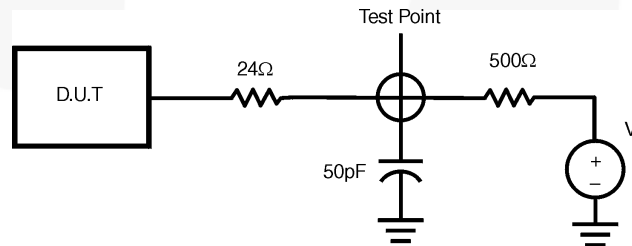
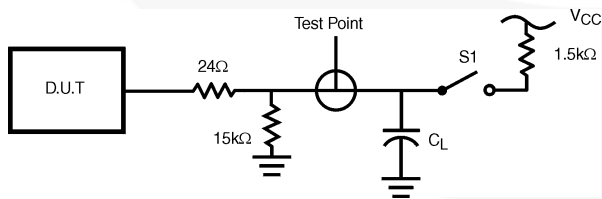

Figure 8. Load for Enable and Disable Times



$C_L=50\text{pF}$ , Full Speed  
 $C_L=200\text{pF}$ , Full Speed (Minimum Timing)  
 $C_L=600\text{pF}$ , Full Speed (Maximum Timing)  
 1.5k $\Omega$  on D-(Low Speed) or D+ (Full Speed) only.

Test	S1
D-/LS	Close
D+/LS	Open
D-/FS	Open
D+/FS	Close

Figure 9. Load for D+/D-



Physical Dimensions

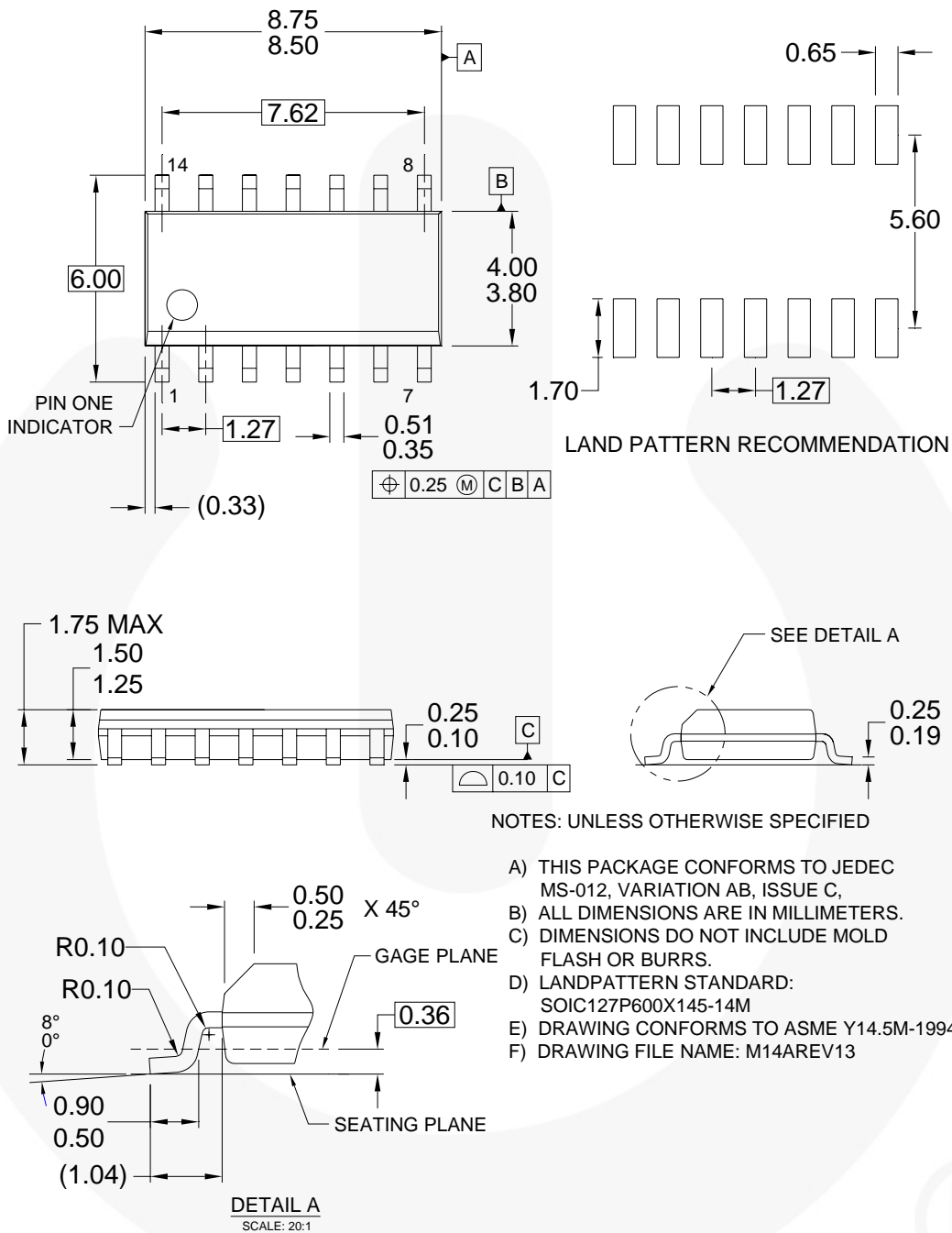
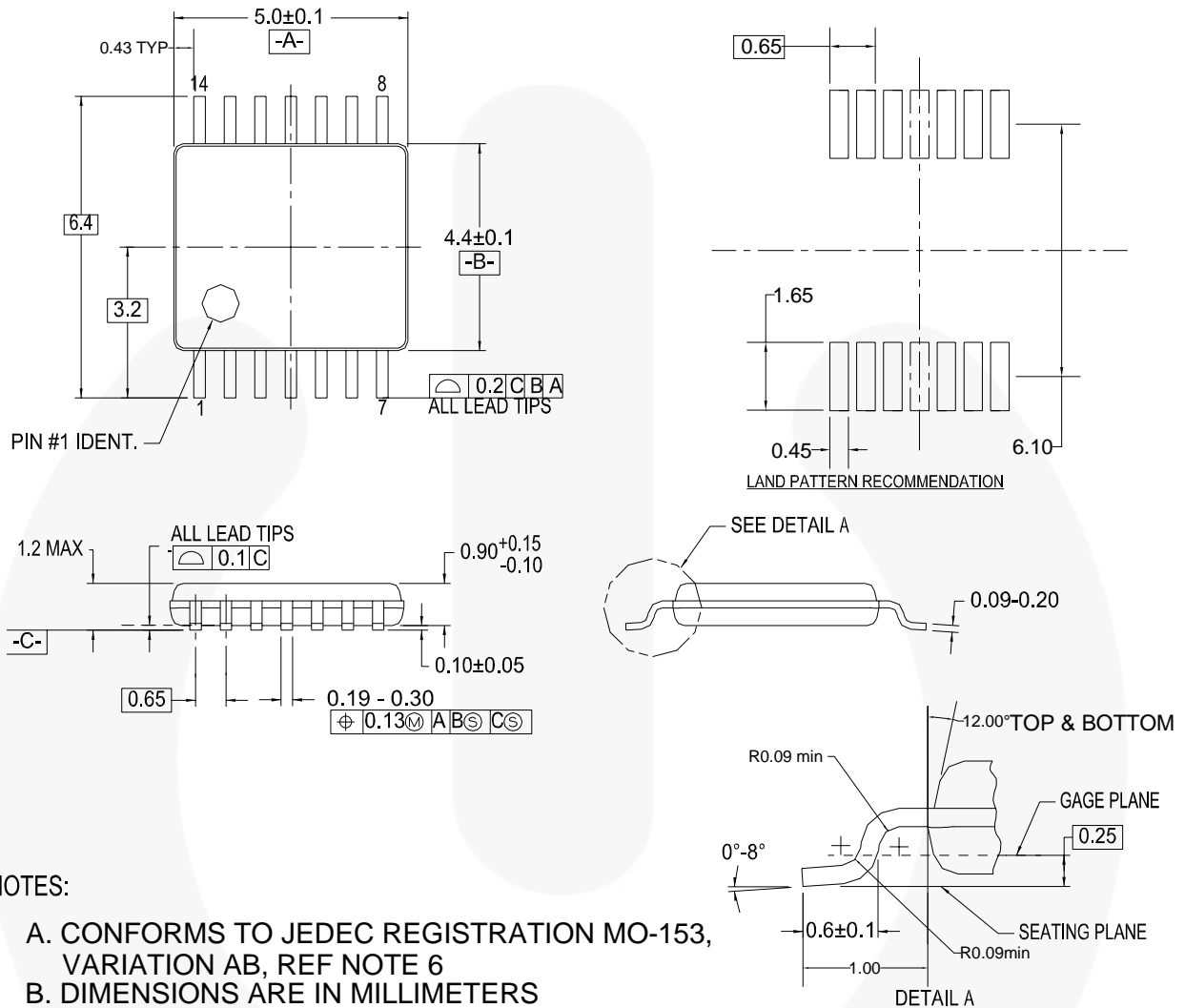

Figure 10. 14-Lead, Small Outline Integrated Circuit (SOIC) MO-012, 0.150-inch Wide

Package drawings are provided as a service to customers considering Fairchild components. Drawings may change in any manner without notice. Please note the revision and/or date on the drawing and contact a Fairchild Semiconductor representative to verify or obtain the most recent revision. Package specifications do not expand the terms of Fairchild's worldwide terms and conditions, specifically the warranty therein, which covers Fairchild products.

Always visit Fairchild Semiconductor's online packaging area for the most recent package drawings:  
<http://www.fairchildsemi.com/packaging/>

## Physical Dimensions



### NOTES:

- A. CONFORMS TO JEDEC REGISTRATION MO-153, VARIATION AB, REF NOTE 6
- B. DIMENSIONS ARE IN MILLIMETERS
- C. DIMENSIONS ARE EXCLUSIVE OF BURRS, MOLD FLASH, AND TIE BAR EXTRUSIONS
- D. DIMENSIONING AND TOLERANCES PER ANSI Y14.5M, 1982
- E. LANDPATTERN STANDARD: SOP65P640X110-14M
- F. DRAWING FILE NAME: MTC14REV6

**Figure 11. 14-Lead Thin Shrink Small Outline Package (TSSOP), JEDEC MO-153, 4.4mm Wide**







Package drawings are provided as a service to customers considering Fairchild components. Drawings may change in any manner without notice. Please note the revision and/or date on the drawing and contact a Fairchild Semiconductor representative to verify or obtain the most recent revision. Package specifications do not expand the terms of Fairchild's worldwide terms and conditions, specifically the warranty therein, which covers Fairchild products.

Always visit Fairchild Semiconductor's online packaging area for the most recent package drawings:  
<http://www.fairchildsemi.com/packaging/>



**TRADEMARKS**

The following includes registered and unregistered trademarks and service marks, owned by Fairchild Semiconductor and/or its global subsidiaries, and is not intended to be an exhaustive list of all such trademarks.

- |                                                                                              |                                                                                            |                                                                                                                         |                                                                                                         |
|----------------------------------------------------------------------------------------------|--------------------------------------------------------------------------------------------|-------------------------------------------------------------------------------------------------------------------------|---------------------------------------------------------------------------------------------------------|
| AccuPower™                                                                                   | F-PFS™                                                                                     | Power-SPM™                                                                                                              |  SYSTEM GENERAL®     |
| Auto-SPM™                                                                                    | FRFET®                                                                                     | PowerTrench®                                                                                                            | The Power Franchise®                                                                                    |
| Build it Now™                                                                                | Global Power Resource™                                                                     | PowerXS™                                                                                                                |  the power franchise |
| CorePLUS™                                                                                    | Green FPST™                                                                                | Programmable Active Droop™                                                                                              | TinyBoost™                                                                                              |
| CorePOWER™                                                                                   | Green FPST™ e-Series™                                                                      | QFET®                                                                                                                   | TinyBuck™                                                                                               |
| CROSSVOLT™                                                                                   | Gmax™                                                                                      | QS™                                                                                                                     | TinyCalc™                                                                                               |
| CTL™                                                                                         | GTO™                                                                                       | Quiet Series™                                                                                                           | TinyLogic®                                                                                              |
| Current Transfer Logic™                                                                      | IntelliMAX™                                                                                | RapidConfigure™                                                                                                         | TINYOPTO™                                                                                               |
| DEUXPEED®                                                                                    | ISOPLANAR™                                                                                 |  Saving our world, 1mW/W/kW at a time™ | TinyPower™                                                                                              |
| Dual Cool™                                                                                   | MegaBuck™                                                                                  | SignalWise™                                                                                                             | TinyPWM™                                                                                                |
| EcoSPARK®                                                                                    | MICROCOUPLER™                                                                              | SmartMax™                                                                                                               | TinyWire™                                                                                               |
| EfficientMax™                                                                                | MicroFET™                                                                                  | SMART START™                                                                                                            | TriFault Detect™                                                                                        |
| ESBC™                                                                                        | MicroPak™                                                                                  | SPM®                                                                                                                    | TRUECURRENT™*                                                                                           |
|  Fairchild® | MicroPak2™                                                                                 | STEALTH™                                                                                                                | µSerDes™                                                                                                |
| Fairchild Semiconductor®                                                                     | MillerDrive™                                                                               | SuperFET™                                                                                                               |  SerDes™             |
| FACT Quiet Series™                                                                           | MotionMax™                                                                                 | SuperSOT™-3                                                                                                             | UHC®                                                                                                    |
| FACT®                                                                                        | Motion-SPM™                                                                                | SuperSOT™-6                                                                                                             | Ultra FRFET™                                                                                            |
| FAST®                                                                                        | OptoHIT™                                                                                   | SuperSOT™-8                                                                                                             | UniFET™                                                                                                 |
| FAST®                                                                                        | OPTOLOGIC®                                                                                 | SupreMOS®                                                                                                               | Vcx™                                                                                                    |
| FastvCore™                                                                                   | OPTOPLANAR®                                                                                | SyncFET™                                                                                                                | VisualMax™                                                                                              |
| FETBench™                                                                                    |  PDP SPM™ | Sync-Lock™                                                                                                              | XS™                                                                                                     |
| FlashWriter®*                                                                                |                                                                                            |                                                                                                                         |                                                                                                         |
| FPS™                                                                                         |                                                                                            |                                                                                                                         |                                                                                                         |

\* Trademarks of System General Corporation, used under license by Fairchild Semiconductor.

**DISCLAIMER**

FAIRCHILD SEMICONDUCTOR RESERVES THE RIGHT TO MAKE CHANGES WITHOUT FURTHER NOTICE TO ANY PRODUCTS HEREIN TO IMPROVE RELIABILITY, FUNCTION, OR DESIGN. FAIRCHILD DOES NOT ASSUME ANY LIABILITY ARISING OUT OF THE APPLICATION OR USE OF ANY PRODUCT OR CIRCUIT DESCRIBED HEREIN; NEITHER DOES IT CONVEY ANY LICENSE UNDER ITS PATENT RIGHTS, NOR THE RIGHTS OF OTHERS. THESE SPECIFICATIONS DO NOT EXPAND THE TERMS OF FAIRCHILD'S WORLDWIDE TERMS AND CONDITIONS, SPECIFICALLY THE WARRANTY THEREIN, WHICH COVERS THESE PRODUCTS.

**LIFE SUPPORT POLICY**

FAIRCHILD'S PRODUCTS ARE NOT AUTHORIZED FOR USE AS CRITICAL COMPONENTS IN LIFE SUPPORT DEVICES OR SYSTEMS WITHOUT THE EXPRESS WRITTEN APPROVAL OF FAIRCHILD SEMICONDUCTOR CORPORATION.

As used herein:

- Life support devices or systems are devices or systems which, (a) are intended for surgical implant into the body or (b) support or sustain life, and (c) whose failure to perform when properly used in accordance with instructions for use provided in the labeling, can be reasonably expected to result in a significant injury of the user.
- A critical component in any component of a life support, device, or system whose failure to perform can be reasonably expected to cause the failure of the life support device or system, or to affect its safety or effectiveness.

**ANTI-COUNTERFEITING POLICY**

Fairchild Semiconductor Corporation's Anti-Counterfeiting Policy. Fairchild's Anti-Counterfeiting Policy is also stated on our external website, [www.fairchildsemi.com](http://www.fairchildsemi.com), under Sales Support.

Counterfeiting of semiconductor parts is a growing problem in the industry. All manufacturers of semiconductor products are experiencing counterfeiting of their parts. Customers who inadvertently purchase counterfeit parts experience many problems such as loss of brand reputation, substandard performance, failed applications, and increased cost of production and manufacturing delays. Fairchild is taking strong measures to protect ourselves and our customers from the proliferation of counterfeit parts. Fairchild strongly encourages customers to purchase Fairchild parts either directly from Fairchild or from Authorized Fairchild Distributors who are listed by country on our web page cited above. Products customers buy either from Fairchild directly or from Authorized Fairchild Distributors are genuine parts, have full traceability, meet Fairchild's quality standards for handling and storage and provide access to Fairchild's full range of up-to-date technical and product information. Fairchild and our Authorized Distributors will stand behind all warranties and will appropriately address any warranty issues that may arise. Fairchild will not provide any warranty coverage or other assistance for parts bought from Unauthorized Sources. Fairchild is committed to combat this global problem and encourage our customers to do their part in stopping this practice by buying direct or from authorized distributors.

**PRODUCT STATUS DEFINITIONS**

**Definition of Terms**

Datasheet Identification	Product Status	Definition
Advance Information	Formative / In Design	Datasheet contains the design specifications for product development. Specifications may change in any manner without notice.
Preliminary	First Production	Datasheet contains preliminary data; supplementary data will be published at a later date. Fairchild Semiconductor reserves the right to make changes at any time without notice to improve design.
No Identification Needed	Full Production	Datasheet contains final specifications. Fairchild Semiconductor reserves the right to make changes at any time without notice to improve the design.
Obsolete	Not In Production	Datasheet contains specifications on a product that is discontinued by Fairchild Semiconductor. The datasheet is for reference information only.

Rev. 149

ON Semiconductor and  are trademarks of Semiconductor Components Industries, LLC dba ON Semiconductor or its subsidiaries in the United States and/or other countries. ON Semiconductor owns the rights to a number of patents, trademarks, copyrights, trade secrets, and other intellectual property. A listing of ON Semiconductor's product/patent coverage may be accessed at [www.onsemi.com/site/pdf/Patent-Marking.pdf](http://www.onsemi.com/site/pdf/Patent-Marking.pdf). ON Semiconductor reserves the right to make changes without further notice to any products herein. ON Semiconductor makes no warranty, representation or guarantee regarding the suitability of its products for any particular purpose, nor does ON Semiconductor assume any liability arising out of the application or use of any product or circuit, and specifically disclaims any and all liability, including without limitation special, consequential or incidental damages. Buyer is responsible for its products and applications using ON Semiconductor products, including compliance with all laws, regulations and safety requirements or standards, regardless of any support or applications information provided by ON Semiconductor. "Typical" parameters which may be provided in ON Semiconductor data sheets and/or specifications can and do vary in different applications and actual performance may vary over time. All operating parameters, including "Typicals" must be validated for each customer application by customer's technical experts. ON Semiconductor does not convey any license under its patent rights nor the rights of others. ON Semiconductor products are not designed, intended, or authorized for use as a critical component in life support systems or any FDA Class 3 medical devices or medical devices with a same or similar classification in a foreign jurisdiction or any devices intended for implantation in the human body. Should Buyer purchase or use ON Semiconductor products for any such unintended or unauthorized application, Buyer shall indemnify and hold ON Semiconductor and its officers, employees, subsidiaries, affiliates, and distributors harmless against all claims, costs, damages, and expenses, and reasonable attorney fees arising out of, directly or indirectly, any claim of personal injury or death associated with such unintended or unauthorized use, even if such claim alleges that ON Semiconductor was negligent regarding the design or manufacture of the part. ON Semiconductor is an Equal Opportunity/Affirmative Action Employer. This literature is subject to all applicable copyright laws and is not for resale in any manner.

## PUBLICATION ORDERING INFORMATION

### LITERATURE FULFILLMENT:

Literature Distribution Center for ON Semiconductor  
19521 E. 32nd Pkwy, Aurora, Colorado 80011 USA  
**Phone:** 303-675-2175 or 800-344-3860 Toll Free USA/Canada  
**Fax:** 303-675-2176 or 800-344-3867 Toll Free USA/Canada  
**Email:** [orderlit@onsemi.com](mailto:orderlit@onsemi.com)

**N. American Technical Support:** 800-282-9855 Toll Free  
USA/Canada  
**Europe, Middle East and Africa Technical Support:**  
Phone: 421 33 790 2910  
**Japan Customer Focus Center**  
Phone: 81-3-5817-1050

**ON Semiconductor Website:** [www.onsemi.com](http://www.onsemi.com)  
**Order Literature:** <http://www.onsemi.com/orderlit>  
For additional information, please contact your local  
Sales Representative