

**PLEASE CHECK WWW.MOLEX.COM FOR LATEST PART INFORMATION**

**Part Number:** **0190020044**  
**Status:** **Active**  
**Overview:** Standard Quick-Disconnect Terminals  
**Description:** Avikrimp™ Quick Disconnect, Female, for 10-12 (5.00-3.30mm<sup>2</sup>) Wire, Box, Tab 6.35 x 0.81mm

**Documents:**

<a href="#">3D Model</a>	<a href="#">Product Specification PS-19902-013-001 (PDF)</a>
<a href="#">Drawing (PDF)</a>	<a href="#">Product Specification PS-19902-014-001 (PDF)</a>
<a href="#">Product Specification PS-19902-011-001 (PDF)</a>	<a href="#">RoHS Certificate of Compliance (PDF)</a>

**Agency Certification**

CSA	LR18689
UL	E79133

**General**

Product Family	Quick Disconnects
Series	<u>19002</u>
Crimp Quality Equipment	Yes
Insulated	Fully
Overview	<u>Standard Quick-Disconnect Terminals</u>
Product Name	Avikrimp™
Type	Quick Disconnect
UPC	800753027763

**Physical**

Barrel Type	Closed
Color - Resin	Yellow
Flammability	94V-2
Gender	Female
Glow-Wire Compliant	Yes
Insulation	Nylon (PA)
Lock to Mating Part	None
Material - Metal	Brass
Material - Plating Mating	Tin
Material - Plating Termination	Tin
Net Weight	1.941/g
Orientation	Straight
Packaging Type	Bag
Polarized to Mating Part	No
Tab Thickness	0.81mm
Tab Width	6.35mm
Temperature Range - Operating	-65°C to +105°C
Wire Insulation Diameter	6.22mm max.
Wire Size AWG	10, 12

**Electrical**

Voltage - Maximum	300V
-------------------	------

**Solder Process Data**

Lead-free Process Capability	N/A
------------------------------	-----

**Material Info**

Engineering Number	C-5265
--------------------	--------

**Reference - Drawing Numbers**

Product Specification	PS-19902-011-001, PS-19902-013-001, PS-19902-014-001
-----------------------	--

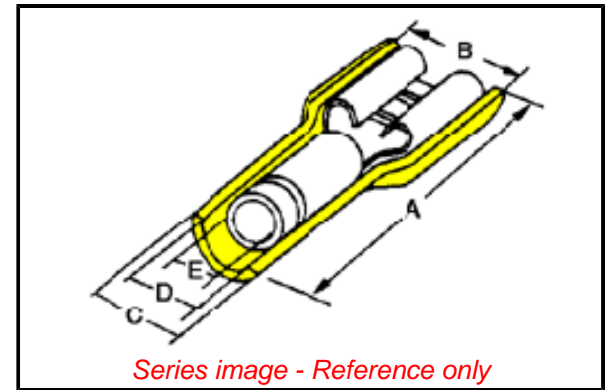

*Series image - Reference only*

**EU ELV**

**Not Relevant**

**EU RoHS**

**Compliant**

**REACH SVHC**

Not Contained Per - ED/21/2016 (20 June 2016)

**Halogen-Free**

**Status**

**Low-Halogen**

**Need more information on product environmental compliance?**

Email [productcompliance@molex.com](mailto:productcompliance@molex.com)  
Please visit the [Contact Us](#) section for any non-product compliance questions.

China ROHS

ELV

RoHS Phthalates

Green Image

Not Relevant

Not Contained

**Search Parts in this Series**

19002 Series

**Use With**

19001-0010 , 19001-0011

This document was generated on 02/15/2017

**PLEASE CHECK [WWW.MOLEX.COM](http://WWW.MOLEX.COM) FOR LATEST PART INFORMATION**