



Is Now Part of



ON Semiconductor®

To learn more about ON Semiconductor, please visit our website at

www.onsemi.com

ON Semiconductor and the ON Semiconductor logo are trademarks of Semiconductor Components Industries, LLC dba ON Semiconductor or its subsidiaries in the United States and/or other countries. ON Semiconductor owns the rights to a number of patents, trademarks, copyrights, trade secrets, and other intellectual property. A listing of ON Semiconductor's product/patent coverage may be accessed at www.onsemi.com/site/pdf/Patent-Marking.pdf. ON Semiconductor reserves the right to make changes without further notice to any products herein. ON Semiconductor makes no warranty, representation or guarantee regarding the suitability of its products for any particular purpose, nor does ON Semiconductor assume any liability arising out of the application or use of any product or circuit, and specifically disclaims any and all liability, including without limitation special, consequential or incidental damages. Buyer is responsible for its products and applications using ON Semiconductor products, including compliance with all laws, regulations and safety requirements or standards, regardless of any support or applications information provided by ON Semiconductor. "Typical" parameters which may be provided in ON Semiconductor data sheets and/or specifications can and do vary in different applications and actual performance may vary over time. All operating parameters, including "Typicals" must be validated for each customer application by customer's technical experts. ON Semiconductor does not convey any license under its patent rights nor the rights of others. ON Semiconductor products are not designed, intended, or authorized for use as a critical component in life support systems or any FDA Class 3 medical devices or medical devices with a same or similar classification in a foreign jurisdiction or any devices intended for implantation in the human body. Should Buyer purchase or use ON Semiconductor products for any such unintended or unauthorized application, Buyer shall indemnify and hold ON Semiconductor and its officers, employees, subsidiaries, affiliates, and distributors harmless against all claims, costs, damages, and expenses, and reasonable attorney fees arising out of, directly or indirectly, any claim of personal injury or death associated with such unintended or unauthorized use, even if such claim alleges that ON Semiconductor was negligent regarding the design or manufacture of the part. ON Semiconductor is an Equal Opportunity/Affirmative Action Employer. This literature is subject to all applicable copyright laws and is not for resale in any manner.



July 2015

MC78LXXA / LM78LXXA

3-Terminal 0.1 A Positive Voltage Regulator

Features

- Maximum Output Current of 100 mA
- Output Voltage of 5 V, 6 V, 8 V, 12 V, and 15 V
- Thermal Overload Protection
- Short-Circuit Current Limiting
- Output Voltage Offered in $\pm 5\%$ Tolerance

Description

The MC78LXXA / LM78LXXA series of fixed-voltage monolithic integrated circuit voltage regulators are suitable for applications that required supply current up to 100 mA.

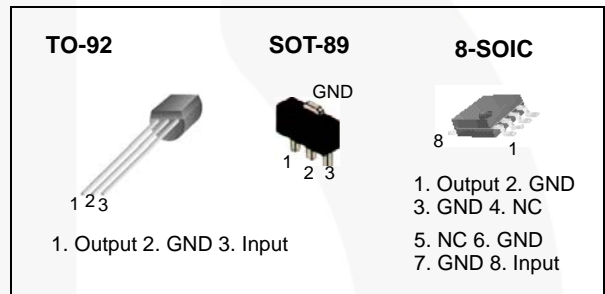

Ordering Information

Product Number	Package	Packing Method	Output Voltage Tolerance	Operating Temperature
LM78L05ACZ	TO-92	Bulk	$\pm 5\%$	-40 to +125°C
LM78L05ACZX		Tape & Reel		
LM78L05ACZXA		Ammo		
LM78L12ACZ		Bulk		
LM78L12ACZX		Tape & Reel		
MC78L05ACP		Bulk		
MC78L05ACPXA		Ammo		
MC78L06ACP		Bulk		
MC78L08ACP		Bulk		
MC78L15ACP		Bulk		
MC78L15ACPXA		Ammo		
MC78L05ACD		8-SOIC		
MC78L05ACDX	Tape & Reel			
MC78L05ACHX	SOT-89	Tape & Reel		
MC78L08ACHX		Tape & Reel		

MC78LXXA / LM78LXXA — 3-Terminal 0.1 A Positive Voltage Regulator

Block Diagram



Figure 1. Block Diagram

Absolute Maximum Ratings

Stresses exceeding the absolute maximum ratings may damage the device. The device may not function or be operable above the recommended operating conditions and stressing the parts to these levels is not recommended. In addition, extended exposure to stresses above the recommended operating conditions may affect device reliability. The absolute maximum ratings are stress ratings only. Values are at $T_A = 25^\circ\text{C}$ unless otherwise noted.

Symbol	Parameter		Value	Unit
V_I	Input Voltage	$V_O = 5\text{ V to }8\text{ V}$	30	V
		$V_O = 12\text{ V to }15\text{ V}$	35	V
T_{OPR}	Operating Temperature Range		-40 to +125°C	°C
$T_{\text{J(MAX)}}$	Maximum Junction Temperature		150	°C
T_{STG}	Storage Temperature Range		-65 to +150	°C
$R_{\theta\text{JC}}$	Thermal Resistance, Junction-Case	TO-92	50	°C/W
$R_{\theta\text{JA}}$	Thermal Resistance, Junction-Air	TO-92	150	°C/W
		SOT-89	225	°C/W
		8-SOIC	160	°C/W

Electrical Characteristics (MC78L05A / LM78L05A)

$V_I = 10\text{ V}$, $I_O = 40\text{ mA}$, $-40^\circ\text{C} \leq T_J \leq 125^\circ\text{C}$, $C_I = 0.33\ \mu\text{F}$, $C_O = 0.1\ \mu\text{F}$, unless otherwise specified.

Symbol	Parameter	Conditions	Min.	Typ.	Max.	Unit	
V_O	Output Voltage	$T_J = 25^\circ\text{C}$	4.8	5.0	5.2	V	
ΔV_O	Line Regulation ⁽¹⁾	$T_J = 25^\circ\text{C}$	$7\text{ V} \leq V_I \leq 20\text{ V}$		8	150	mV
			$8\text{ V} \leq V_I \leq 20\text{ V}$		6	100	mV
ΔV_O	Load Regulation ⁽¹⁾	$T_J = 25^\circ\text{C}$	$1\text{ mA} \leq I_O \leq 100\text{ mA}$		11	60	mV
			$1\text{ mA} \leq I_O \leq 40\text{ mA}$		5.0	30.0	mV
V_O	Output Voltage	$7\text{ V} \leq V_I \leq 20\text{ V}$	$1\text{ mA} \leq I_O \leq 40\text{ mA}$			5.25	V
		$7\text{ V} \leq V_I \leq V_{\text{MAX}}^{(2)}$	$1\text{ mA} \leq I_O \leq 70\text{ mA}$	4.75		5.25	V
I_Q	Quiescent Current	$T_J = 25^\circ\text{C}$		2.0	5.5	mA	
ΔI_Q	Quiescent Current Change	With Line	$8\text{ V} \leq V_I \leq 20\text{ V}$			1.5	mA
ΔI_Q		With Load	$1\text{ mA} \leq I_O \leq 40\text{ mA}$			0.1	mA
V_N	Output Noise Voltage	$T_A = 25^\circ\text{C}$, $10\text{ Hz} \leq f \leq 100\text{ kHz}$		40		$\mu\text{V}/V_O$	
$\Delta V_O/\Delta T$	Temperature Coefficient of V_O	$I_O = 5\text{ mA}$		-0.65		$\text{mV}/^\circ\text{C}$	
RR	Ripple Rejection	$f = 120\text{ Hz}$, $8\text{ V} \leq V_I \leq 18\text{ V}$, $T_J = 25^\circ\text{C}$	41	80		dB	
V_D	Dropout Voltage	$T_J = 25^\circ\text{C}$		1.7		V	

Notes:

1. The maximum steady-state usable output current and input voltage are very dependent on the heat sinking and/or lead length of the package. The data above represents pulse test conditions with junction temperature as indicated at the initiation of tests.
2. Power dissipation $P_D \leq 0.75\text{ W}$.

Electrical Characteristics (MC78L06A)

$V_I = 12\text{ V}$, $I_O = 40\text{ mA}$, $-40^\circ\text{C} \leq T_J \leq 125^\circ\text{C}$, $C_I = 0.33\ \mu\text{F}$, $C_O = 0.1\ \mu\text{F}$, unless otherwise specified.

Symbol	Parameter	Conditions	Min.	Typ.	Max.	Unit
V_O	Output Voltage	$T_J = 25^\circ\text{C}$	5.75	6.0	6.25	V
ΔV_O	Line Regulation ⁽³⁾	$T_J = 25^\circ\text{C}$ $8.5\text{ V} \leq V_I \leq 20\text{ V}$		64	175	mV
		$9\text{ V} \leq V_I \leq 20\text{ V}$		54	125	mV
ΔV_O	Load Regulation ⁽³⁾	$T_J = 25^\circ\text{C}$ $1\text{ mA} \leq I_O \leq 100\text{ mA}$		12.8	80.0	mV
		$1\text{ mA} \leq I_O \leq 70\text{ mA}$		5.8	40.0	mV
V_O	Output Voltage	$8.5\text{ V} \leq V_I \leq 20\text{ V}$, $1\text{ mA} \leq I_O \leq 40\text{ mA}$	5.7		6.3	V
		$8.5\text{ V} \leq V_I \leq V_{MAX}^{(4)}$, $1\text{ mA} \leq I_O \leq 70\text{ mA}$	5.7		6.3	V
I_Q	Quiescent Current	$T_J = 25^\circ\text{C}$			5.5	mA
		$T_J = 125^\circ\text{C}$		3.9	6.0	mA
ΔI_Q	Quiescent Current Change	With Line $9\text{ V} \leq V_I \leq 20\text{ V}$			1.5	mA
ΔI_Q		With Load $1\text{ mA} \leq I_O \leq 40\text{ mA}$			0.1	mA
V_N	Output Noise Voltage	$T_A = 25^\circ\text{C}$, $10\text{ Hz} \leq f \leq 100\text{ kHz}$		40		$\mu\text{V}/V_O$
$\Delta V_O/\Delta T$	Temperature Coefficient of V_O	$I_O = 5\text{ mA}$		0.75		$\text{mV}/^\circ\text{C}$
RR	Ripple Rejection	$f = 120\text{ Hz}$, $10\text{ V} \leq V_I \leq 20\text{ V}$, $T_J = 25^\circ\text{C}$	40	46		dB
V_D	Dropout Voltage	$T_J = 25^\circ\text{C}$		1.7		V

Notes:

3. The maximum steady-state usable output current and input voltage are very dependent on the heat sinking and/or lead length of the package. The data above represents pulse test conditions with junction temperature as indicated at the initiation of tests.
4. Power dissipation $P_D \leq 0.75\text{ W}$.

Electrical Characteristics (MC78L08A)

$V_I = 14\text{ V}$, $I_O = 40\text{ mA}$, $-40^\circ\text{C} \leq T_J \leq 125^\circ\text{C}$, $C_I = 0.33\ \mu\text{F}$, $C_O = 0.1\ \mu\text{F}$, unless otherwise specified.

Symbol	Parameter	Conditions	Min.	Typ.	Max.	Unit	
V_O	Output Voltage	$T_J = 25^\circ\text{C}$	7.7	8.0	8.3	V	
ΔV_O	Line Regulation ⁽⁵⁾	$T_J = 25^\circ\text{C}$	$10.5\text{ V} \leq V_I \leq 23\text{ V}$		10	175	mV
			$11\text{ V} \leq V_I \leq 23\text{ V}$		8	125	mV
ΔV_O	Load Regulation ⁽⁵⁾	$T_J = 25^\circ\text{C}$	$1\text{ mA} \leq I_O \leq 100\text{ mA}$		15	80	mV
			$1\text{ mA} \leq I_O \leq 40\text{ mA}$		8	40	mV
V_O	Output Voltage	$10.5\text{V} \leq V_I \leq 23\text{V}$	$1\text{ mA} \leq I_O \leq 40\text{ mA}$	7.6		8.4	V
		$10.5\text{V} \leq V_I \leq V_{\text{MAX}}^{(6)}$	$1\text{ mA} \leq I_O \leq 70\text{ mA}$	7.6		8.4	V
I_Q	Quiescent Current	$T_J = 25^\circ\text{C}$		2.0	5.5	mA	
ΔI_Q	Quiescent Current Change	With Line	$11\text{ V} \leq V_I \leq 23\text{ V}$			1.5	mA
ΔI_Q		With Load	$1\text{ mA} \leq I_O \leq 40\text{ mA}$			0.1	mA
V_N	Output Noise Voltage	$T_A = 25^\circ\text{C}$, $10\text{ Hz} \leq f \leq 100\text{ kHz}$		60		$\mu\text{V}/V_O$	
$\Delta V_O/\Delta T$	Temperature Coefficient of V_O	$I_O = 5\text{ mA}$		-0.8		$\text{mV}/^\circ\text{C}$	
RR	Ripple Rejection	$f = 120\text{ Hz}$, $11\text{ V} \leq V_I \leq 21\text{ V}$, $T_J = 25^\circ\text{C}$	39	70		dB	
V_D	Dropout Voltage	$T_J = 25^\circ\text{C}$		1.7		V	

Notes:

5. The maximum steady-state usable output current and input voltage are very dependent on the heat sinking and/or lead length of the package. The data above represents pulse test conditions with junction temperature as indicated at the initiation of tests.
6. Power dissipation $P_D \leq 0.75\text{ W}$.

Electrical Characteristics (MC78L12A / LM78L12A)

$V_I = 19\text{ V}$, $I_O = 40\text{ mA}$, $-40^\circ\text{C} \leq T_J \leq 125^\circ\text{C}$, $C_I = 0.33\ \mu\text{F}$, $C_O = 0.1\ \mu\text{F}$, unless otherwise specified.

Symbol	Parameter	Conditions	Min.	Typ.	Max.	Unit	
V_O	Output Voltage	$T_J = 25^\circ\text{C}$	11.5	12.0	12.5	V	
ΔV_O	Line Regulation ⁽⁷⁾	$T_J = 25^\circ\text{C}$	$14.5\text{ V} \leq V_I \leq 27\text{ V}$	20	250	mV	
			$16\text{ V} \leq V_I \leq 27\text{ V}$	15	200	mV	
ΔV_O	Load Regulation ⁽⁷⁾	$T_J = 25^\circ\text{C}$	$1\text{ mA} \leq I_O \leq 100\text{ mA}$	20	100	mV	
			$1\text{ mA} \leq I_O \leq 40\text{ mA}$	10	50	mV	
V_O	Output Voltage	$14.5\text{ V} \leq V_I \leq 27\text{ V}$	$1\text{ mA} \leq I_O \leq 40\text{ mA}$	11.4		12.6	V
		$14.5\text{ V} \leq V_I \leq V_{\text{MAX}}^{(8)}$	$1\text{ mA} \leq I_O \leq 70\text{ mA}$	11.4		12.6	V
I_Q	Quiescent Current	$T_J = 25^\circ\text{C}$		2.1	6.0	mA	
ΔI_Q	Quiescent Current Change	With Line	$16\text{ V} \leq V_I \leq 27\text{ V}$		1.5	mA	
ΔI_Q		With Load	$1\text{ mA} \leq I_O \leq 40\text{ mA}$		0.1	mA	
V_N	Output Noise Voltage	$T_A = 25^\circ\text{C}$, $10\text{ Hz} \leq f \leq 100\text{ kHz}$		80		$\mu\text{V}/V_O$	
$\Delta V_O/\Delta T$	Temperature Coefficient of V_O	$I_O = 5\text{ mA}$		-1.0		$\text{mV}/^\circ\text{C}$	
RR	Ripple Rejection	$f = 120\text{ Hz}$, $15\text{ V} \leq V_I \leq 25\text{ V}$, $T_J = 25^\circ\text{C}$	37	65		dB	
V_D	Dropout Voltage	$T_J = 25^\circ\text{C}$		1.7		V	

Notes:

7. The maximum steady-state usable output current and input voltage are very dependent on the heat sinking and/or lead length of the package. The data above represents pulse test conditions with junction temperature as indicated at the initiation of tests.
8. Power dissipation $P_D \leq 0.75\text{ W}$.

Electrical Characteristics (MC78L15A)

$V_I = 23\text{ V}$, $I_O = 40\text{ mA}$, $-40^\circ\text{C} \leq T_J \leq 125^\circ\text{C}$, $C_I = 0.33\ \mu\text{F}$, $C_O = 0.1\ \mu\text{F}$, unless otherwise specified.

Symbol	Parameter		Conditions	Min.	Typ.	Max.	Unit	
V_O	Output Voltage		$T_J = 25^\circ\text{C}$	14.4	15.0	15.6	V	
ΔV_O	Line Regulation ⁽⁹⁾		$T_J = 25^\circ\text{C}$	$17.5\text{ V} \leq V_I \leq 30\text{ V}$		25	300	mV
				$20\text{ V} \leq V_I \leq 30\text{ V}$		20	250	mV
ΔV_O	Load Regulation ⁽⁹⁾		$T_J = 25^\circ\text{C}$	$1\text{ mA} \leq I_O \leq 100\text{ mA}$		25	150	mV
				$1\text{ mA} \leq I_O \leq 40\text{ mA}$		12	75	mV
V_O	Output Voltage		$17.5\text{ V} \leq V_I \leq 30\text{ V}$	$1\text{ mA} \leq I_O \leq 40\text{ mA}$	14.25		15.75	V
			$17.5\text{ V} \leq V_I \leq V_{\text{MAX}}^{(10)}$	$1\text{ mA} \leq I_O \leq 70\text{ mA}$	14.25		15.75	V
I_Q	Quiescent Current		$T_J = 25^\circ\text{C}$		2.1	6.0	mA	
ΔI_Q	Quiescent Current Change	With Line	$20\text{ V} \leq V_I \leq 30\text{ V}$			1.5	mA	
ΔI_Q		With Load	$1\text{ mA} \leq I_O \leq 40\text{ mA}$			0.1	mA	
V_N	Output Noise Voltage		$T_A = 25^\circ\text{C}$, $10\text{ Hz} \leq f \leq 100\text{ kHz}$		90		$\mu\text{V}/V_O$	
$\Delta V_O/\Delta T$	Temperature Coefficient of V_O		$I_O = 5\text{ mA}$		-1.3		$\text{mV}/^\circ\text{C}$	
RR	Ripple Rejection		$f = 120\text{ Hz}$, $18.5\text{ V} \leq V_I \leq 28.5\text{ V}$, $T_J = 25^\circ\text{C}$	34	60		dB	
V_D	Dropout Voltage		$T_J = 25^\circ\text{C}$		1.7		V	

Notes:

9. The maximum steady-state usable output current and input voltage are very dependent on the heat sinking and/or lead length of the package. The data above represents pulse test conditions with junction temperature as indicated at the initiation of tests.
10. Power dissipation $P_D \leq 0.75\text{ W}$.

Typical Application

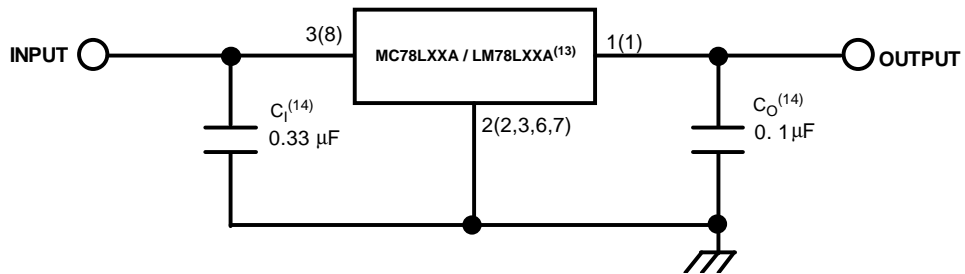
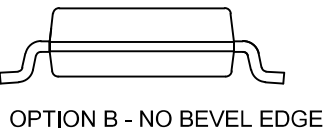
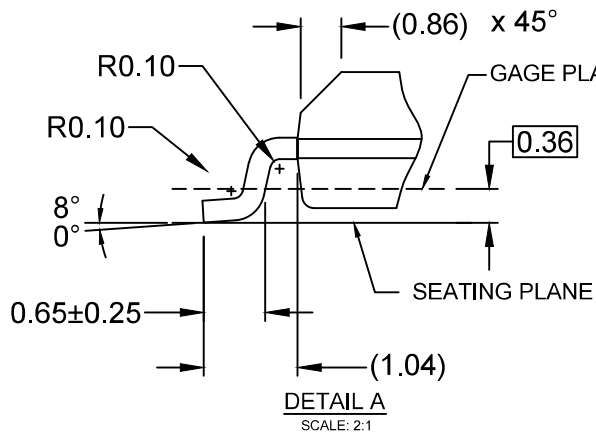
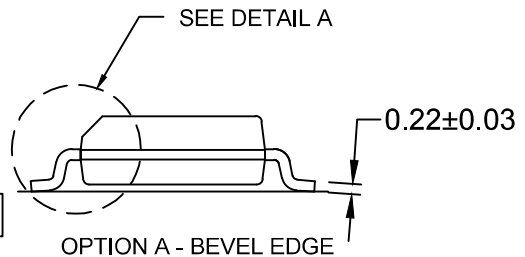
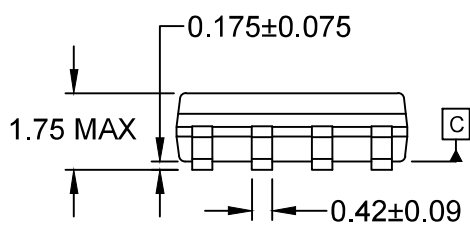
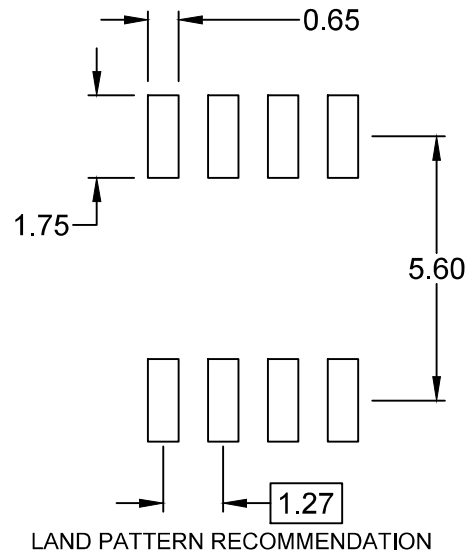

Figure 2. Typical Application

Notes:

13. To specify an output voltage, substitute voltage value for "XX".
14. C_1 is required if the regulator is located an appreciable distance from the power supply filter. Though C_0 is not needed for stability, it improves transient response. Bypass capacitors are recommended for optimum stability and transient response and should be located as close as possible to the regulator.



- NOTES:
- A) THIS PACKAGE CONFORMS TO JEDEC MS-012, VARIATION AA.
 - B) ALL DIMENSIONS ARE IN MILLIMETERS.
 - C) DIMENSIONS DO NOT INCLUDE MOLD FLASH OR BURRS.
 - D) LANDPATTERN STANDARD: SOIC127P600X175-8M
 - E) DRAWING FILENAME: M08Arev16





NOTES: UNLESS OTHERWISE SPECIFIED

- A. DRAWING CONFORMS TO JEDEC MS-013, VARIATION AC.
- B. ALL DIMENSIONS ARE IN MILLIMETERS.
- C. DRAWING CONFORMS TO ASME Y14.5M-2009.
- D. DRAWING FILENAME: MKT-ZA03FREV3.
- E. FAIRCHILD SEMICONDUCTOR.

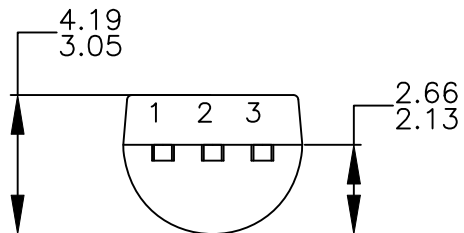

NOTES: UNLESS OTHERWISE SPECIFIED

- A) DRAWING WITH REFERENCE TO JEDEC TO-92 RECOMMENDATIONS.
- B) ALL DIMENSIONS ARE IN MILLIMETERS.
- C) DRAWING CONFORMS TO ASME Y14.5M-2009.
- D) DRAWING FILENAME: MKT-ZA03DREV4.



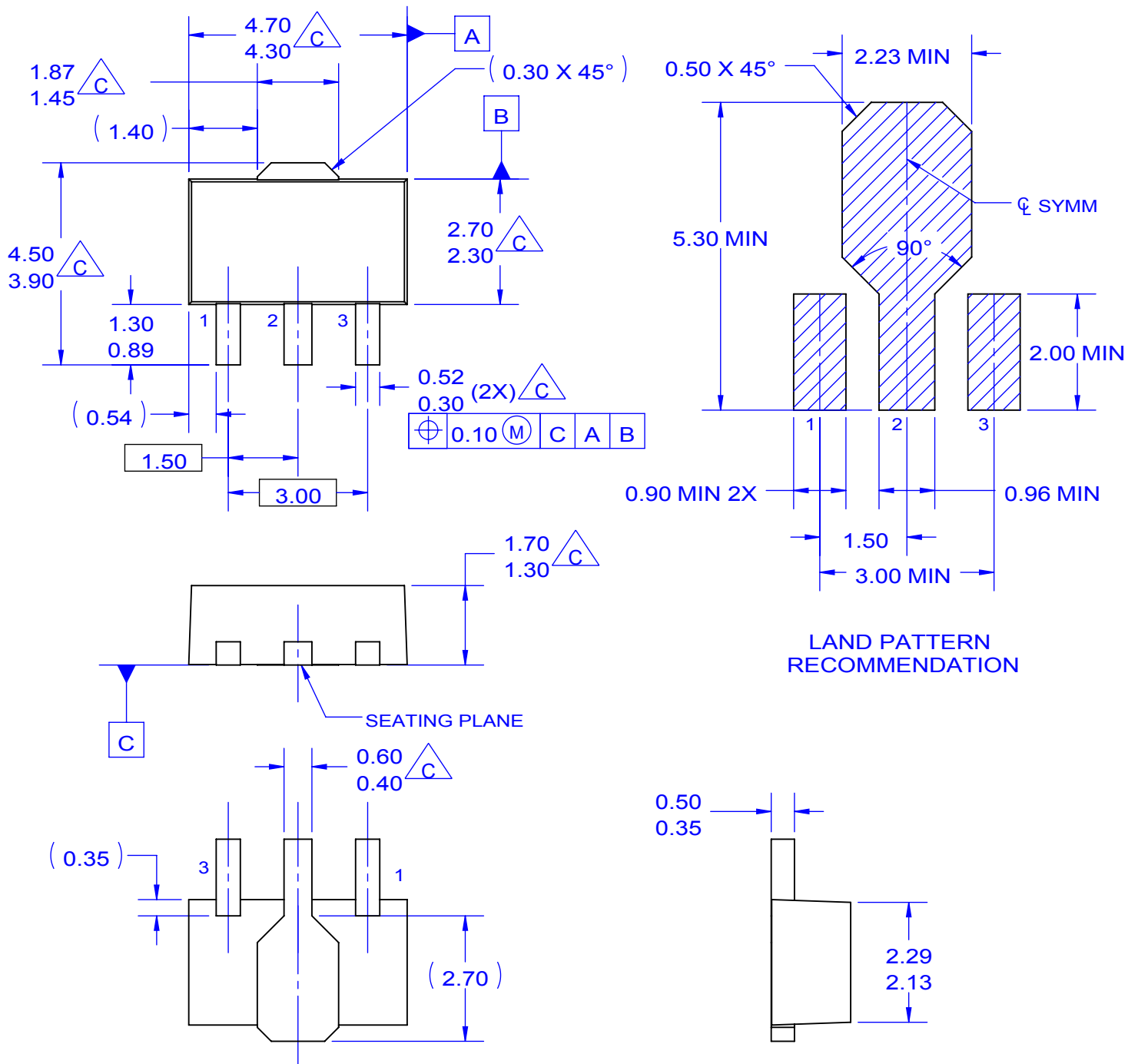

NOTES: UNLESS OTHERWISE SPECIFIED.

A. REFERENCE TO JEDEC TO-243 VARIATION AA.
 B. ALL DIMENSIONS ARE IN MILLIMETERS.

$\triangle C$ DOES NOT COMPLY JEDEC STANDARD VALUE.
 D. DIMENSIONS ARE EXCLUSIVE OF BURRS,
 MOLD FLASH AND TIE BAR PROTRUSION.
 E. DIMENSION AND TOLERANCE AS PER ASME
 Y14.5-1994.

F. DRAWING FILE NAME: MA03CREV3

ON Semiconductor and  are trademarks of Semiconductor Components Industries, LLC dba ON Semiconductor or its subsidiaries in the United States and/or other countries. ON Semiconductor owns the rights to a number of patents, trademarks, copyrights, trade secrets, and other intellectual property. A listing of ON Semiconductor's product/patent coverage may be accessed at www.onsemi.com/site/pdf/Patent-Marking.pdf. ON Semiconductor reserves the right to make changes without further notice to any products herein. ON Semiconductor makes no warranty, representation or guarantee regarding the suitability of its products for any particular purpose, nor does ON Semiconductor assume any liability arising out of the application or use of any product or circuit, and specifically disclaims any and all liability, including without limitation special, consequential or incidental damages. Buyer is responsible for its products and applications using ON Semiconductor products, including compliance with all laws, regulations and safety requirements or standards, regardless of any support or applications information provided by ON Semiconductor. "Typical" parameters which may be provided in ON Semiconductor data sheets and/or specifications can and do vary in different applications and actual performance may vary over time. All operating parameters, including "Typicals" must be validated for each customer application by customer's technical experts. ON Semiconductor does not convey any license under its patent rights nor the rights of others. ON Semiconductor products are not designed, intended, or authorized for use as a critical component in life support systems or any FDA Class 3 medical devices or medical devices with a same or similar classification in a foreign jurisdiction or any devices intended for implantation in the human body. Should Buyer purchase or use ON Semiconductor products for any such unintended or unauthorized application, Buyer shall indemnify and hold ON Semiconductor and its officers, employees, subsidiaries, affiliates, and distributors harmless against all claims, costs, damages, and expenses, and reasonable attorney fees arising out of, directly or indirectly, any claim of personal injury or death associated with such unintended or unauthorized use, even if such claim alleges that ON Semiconductor was negligent regarding the design or manufacture of the part. ON Semiconductor is an Equal Opportunity/Affirmative Action Employer. This literature is subject to all applicable copyright laws and is not for resale in any manner.

PUBLICATION ORDERING INFORMATION

LITERATURE FULFILLMENT:

Literature Distribution Center for ON Semiconductor
19521 E. 32nd Pkwy, Aurora, Colorado 80011 USA
Phone: 303-675-2175 or 800-344-3860 Toll Free USA/Canada
Fax: 303-675-2176 or 800-344-3867 Toll Free USA/Canada
Email: orderlit@onsemi.com

N. American Technical Support: 800-282-9855 Toll Free
USA/Canada
Europe, Middle East and Africa Technical Support:
Phone: 421 33 790 2910
Japan Customer Focus Center
Phone: 81-3-5817-1050

ON Semiconductor Website: www.onsemi.com
Order Literature: <http://www.onsemi.com/orderlit>
For additional information, please contact your local
Sales Representative