

300 W general purpose wide-range SMPS

PFC + TTF Evaluation Board

Author: Andrea Merello

Application Note

About this document

Scope and purpose

The presented evaluation design is a 300 W Switch Mode Power Supply (SMPS) employing the Infineon Combi Controller IC ICE1CS02. The system is partitioned in a Power Factor Correction section (PFC stage) and a Two-Transistor Forward section (TTF stage).

The power supply can be operated from universal input (90 V_{AC} up to 265 V_{AC} at 50~60 Hz) and provides a regulated output of 42 V_{DC}. Alternatively, suggestions are given to obtain 24 V_{DC} or different outputs.

Note: The power board is operated by a control daughterboard using ICE1CS02G. Infineon also offers an alternative solution, using ICE3PCS01G as PFC CCM controller and LM5021-2 as TTF controller. Please see “Addendum to 300 W general purpose wide range SMPS”^[7] on Infineon website.

The design originates from general purpose AC line transformer replacement in low voltage motor drive applications. The design choices are made to allow hard step loads with minimum output drop.

Attention: This board is intended for evaluation purposes only and is not intended to be an end product

Intended audience

Design engineers approaching a Switch Mode Power Supply (SMPS) intended for non continuous load conditions like implemented with Infineon’s 300 W SMPS evaluation board.

Table of contents

1	System and board description	3
1.1	Topology description	3
1.1.1	System protection and features	6
1.1.2	Schematic.....	7
2	AC line input filter and bridge	9
2.1	Input filter layout	9
2.2	Input rectifier bridge	10
3	PFC stage	11

300 W general purpose wide-range SMPS PFC + TTF Evaluation Board



About this document

3.1	PFC inductor design	11
3.2	PFC MOSFET design	13
3.3	PFC Shunt resistor	15
3.4	PFC diode design	16
3.5	PFC capacitor design	16
4	TTF stage	17
4.1	TTF primary side	17
4.1.1	TTF transformer	17
4.1.2	TTF Primary side MOSFETs	19
4.1.3	TTF shunt resistor	21
4.1.4	MOSFET gate driving	21
4.2	TTF secondary side	23
4.2.1	TTF rectifier diodes	23
4.2.2	TTF output passives	25
4.2.3	TTF feedback	26
5	Auxiliary power supply	28
6	Control card with ICE1CS02G	30
6.1	PFC voltage and current loop	31
7	Converter test results	33
7.1	Converter efficiency	33
7.2	Converter waveforms	34
7.2.1	PFC plots	34
7.2.2	TTF plots on primary side	38
7.2.3	TTF plots on secondary side	39
7.2.4	Flyback supply	41
8	Final considerations	43
9	Bill of Material (BOM)	44
10	Appendix A: Average and rms values	47
10.1	Sinusoidal waveform	47
10.2	Rectangular pulse train	48
10.3	Sawtooth waveform	48
10.4	Triangular waveforms	49
11	Appendix B: Chart representation of power MOSFET losses in hard switching	51
12	References and proposed links	53

1 System and board description

The presented design consists in a power supply with aim of reducing system volume and weight, while increasing power factor, standby consumption and efficiency.

The application requirements follow in Table 1:

Table 1 Application requirements

Input	85 V _{AC} to 265 V _{AC}
Input power factor	95% at 150 W @220 V _{AC(in)} ; 99% full load 99% at 150 W @110 V _{AC(in)} ; 99% full load
Output voltage	42 V (24 V variant with changes allowed)
Output power	300 W peak 150 W continuous
Efficiency	90% typ. high-line @220 V _{AC(in)} from 150 W 87% typ. low-line @110 V _{AC(in)} from 150 W
Ambient Temperature	<u>Tested at 25°C ambient</u> Design procedure developed at 70°C ambient

The PFC stage is using Infineon's high voltage MOSFET 600 V CoolMOS™ C6 and Infineon's power silicon diode technology, Rapid 2 Diode. To improve efficiency and reduce commutation noise Infineon's thinQ!™ Generation 5 SiC Schottky Diode can be used. This stage works at a fixed frequency of 65 kHz, both in Discontinued Conduction Mode (DCM) and Continued Conduction Mode (CCM).

The TTF stage takes benefit from 500 V CoolMOS™ CE MOSFET family. This stage works at 130 kHz in CCM mode.

This paper describes a detailed application circuit, the design choices, the PCB drawings, the oscilloscope waveforms and the components. Furthermore, magnetics, power losses evaluation in active devices and heatsink design are included.

1.1 Topology description

The following pictures represent the board topology and it's partitioning with indication of the main components.

For a better explanation, the power supply can be divided into 5 parts, shown in Figure 1.

1. The input filter
2. The PFC stage
3. The TTF stage
4. The output stage
5. The auxiliary supply

300 W general purpose wide-range SMPS PFC + TTF Evaluation Board



System and board description

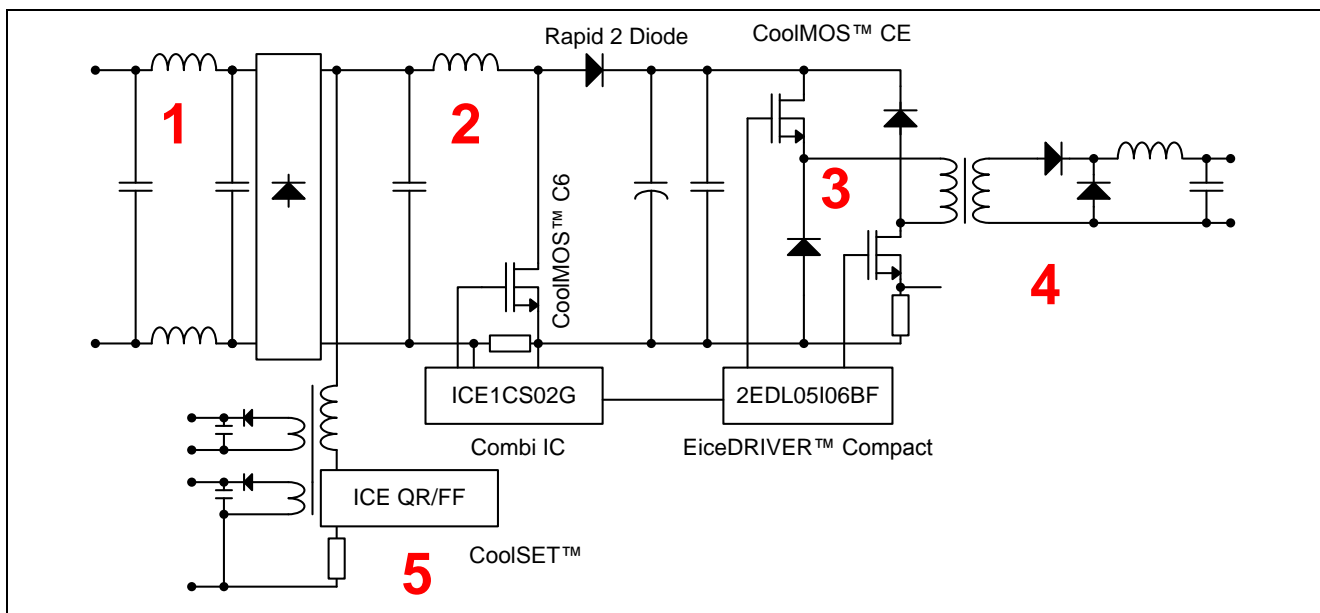

Figure 1 300 W SMPS Evaluationboard - simplified schematic

The following Infineon components are used in the presented design:

Table 2 Used Infineon Components

Product family	Part number	Main parameters	Description	Usage
CoolMOS™ P6	IPP60R190P6	190 mΩ, 600 V	High voltage MOSFET	PFC MOS
thinQ!™ Gen 5	IDH03G65G5	3 A, 650 V	SiC schottky diode	PFC Diode
Rapid2 Diode	IDP08E65D2	8 A, 600 V	Silicon highspeed diode	PFC Diode
CoolMOS™ CE	IPP50R280CE	280 mΩ, 500 V	High voltage MOSFET	TTF MOS
CoolSET™	ICE1CS02G		TTF controller	PFC+TTF IC
CoolSET™	ICE3AR10080JZ	10 Ω, 800 V	Flyback supply	Flyback IC+MOS

300 W general purpose wide-range SMPS PFC + TTF Evaluation Board



System and board description

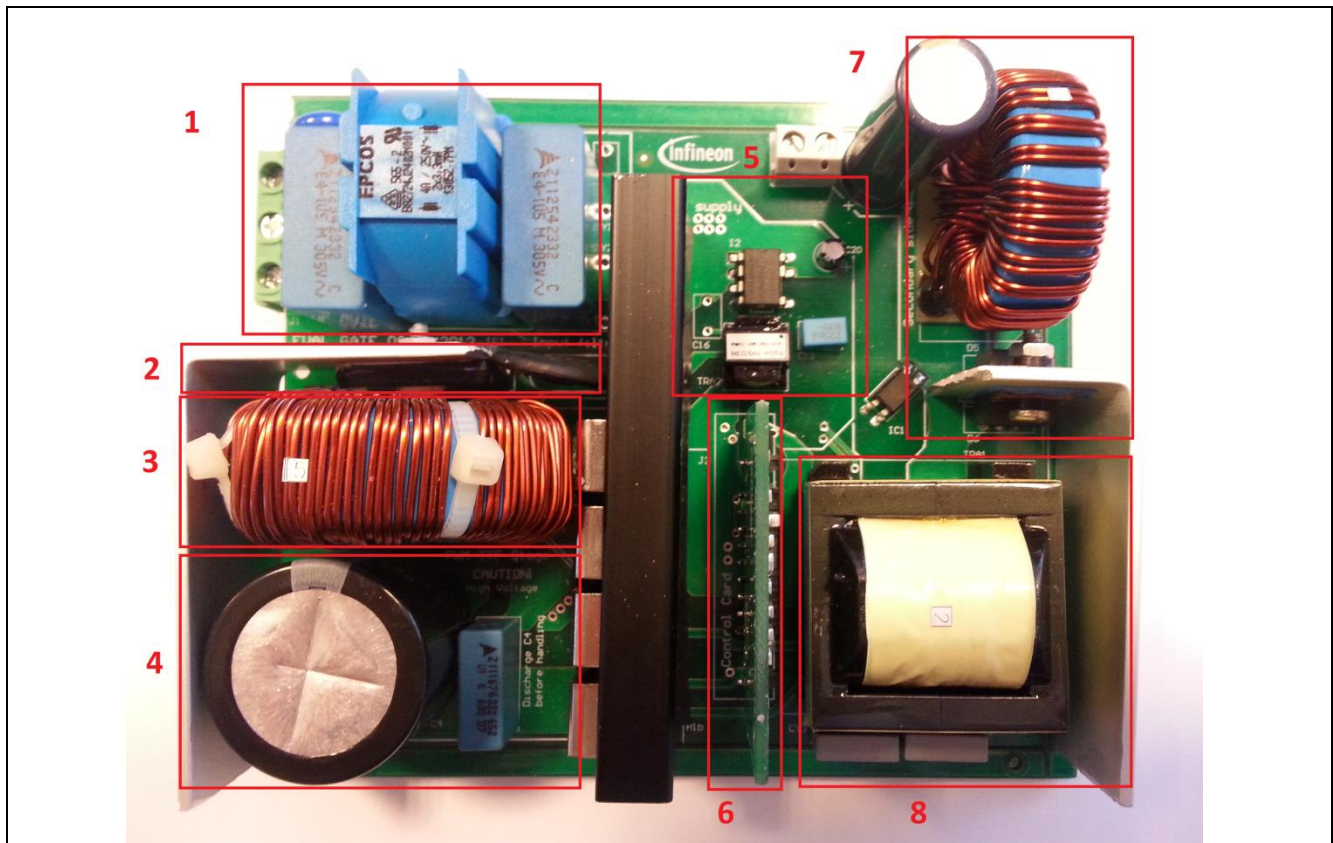

Figure 2 Top view of 300 W SMPS Evaluation board

1. Input filter
2. Input bridge
3. PFC stage (bridge filter, PFC inductor (from PULSE electronics), 600 V CoolMOS™ C6 and Rapid 2 diode/ thinQ!™ SiC Generation 5 diode)
4. TTF stage (bulk and filter capacitor, 500 V CoolMOS™ CE)
5. Auxiliary Flyback supply with CoolSET™
6. Control daughter-board with ICE1CS02G Combi PFC-TTF IC
7. Output inductor (PULSE electronics), capacitor and diodes
8. TTF transformer (PULSE electronics)



Attention: HIGH VOLTAGE!
Discharge completely the bulk capacitor C4 before handling!

300 W general purpose wide-range SMPS PFC + TTF Evaluation Board



System and board description

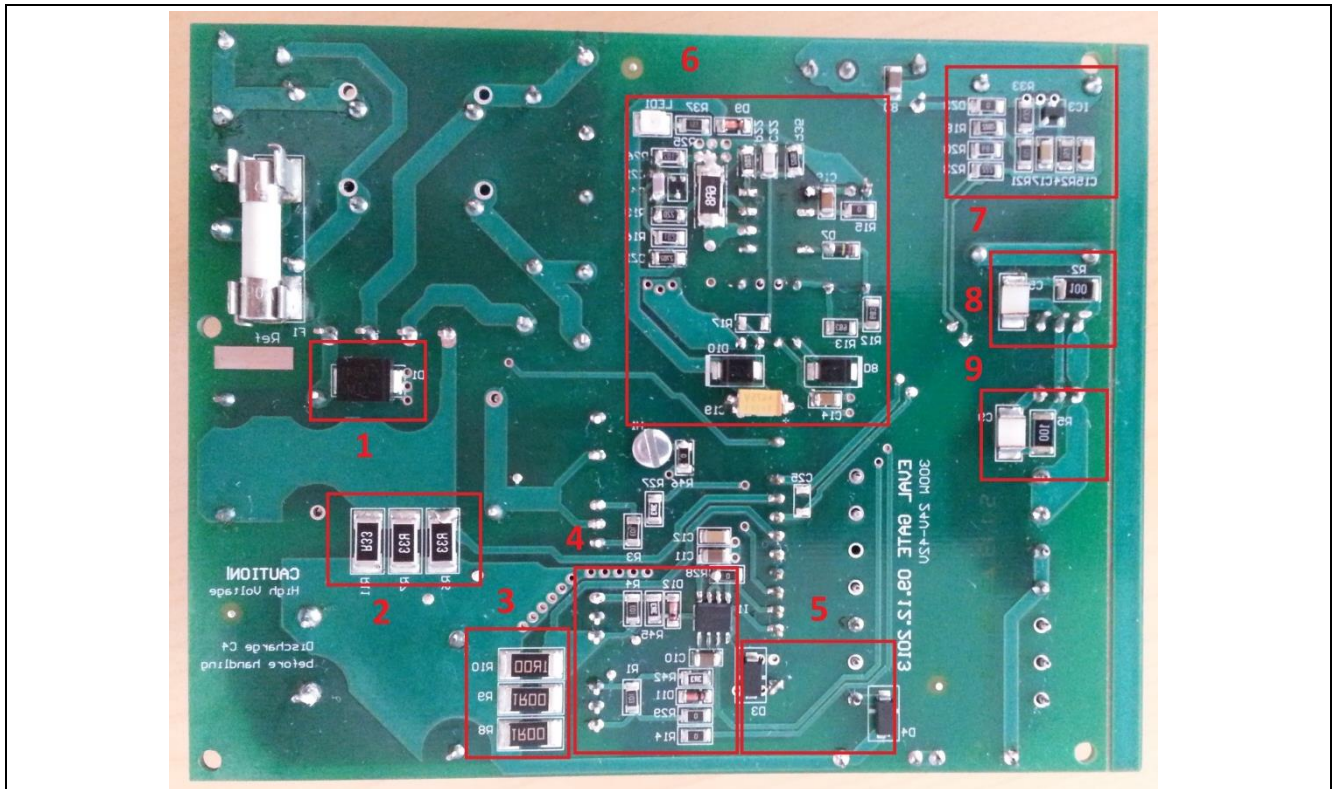

Figure 3 Bottom view of 300 W SMPS Evaluation board (flipped)

1. Bypass diode
2. PFC shunts
3. TTF shunts
4. TTF gate driver 2EDL05I06BF
5. TTF free-wheeling diodes
6. Auxiliary Flyback supply, ICE CoolSET™ design with Fixed Frequency @100 kHz. Quasi Resonant variant possible. GREEN LED indicates operation. When LED is off, bus voltage falls below typ. 50 V
7. TTF feedback network
8. Output rectifier diode snubber
9. Output rectifier diode snubber

1.1.1 System protection and features

The power supply is featured as follows:

PFC

- Cycle-by-cycle overcurrent protection via shunt sensing
- Input Brown-out protection and input under-voltage protection at start-up
- Output redundant overvoltage protection (double sensing)
- Enhanced dynamic response on load jumps and input mains voltage dips
- Soft start of DC bus voltage to limit start-up current
- Frequency synchronization with PWM TTF stage. PFC=65 kHz; TTF=130 kHz.
- Programmable switching frequency by external PWM signal synchronization

300 W general purpose wide-range SMPS PFC + TTF Evaluation Board



System and board description

TTF

- Cycle-by-cycle overcurrent protection via shunt sensing
- Output short circuit protection
- Output overcurrent protection
- Output overvoltage protection
- Output soft start
- DC bus under-voltage protection via PFC
- Slope compensation and limited max duty cycle 47% (or programmable 60%)
- Gate driving under-voltage lockout (UVLO) via gate driver
- Minimum pulse cutout via gate driver

1.1.2 Schematic

The design consists of a Power Board and a Control Card.

Power board and control card schematics are shown respectively in Figure 4 and Figure 5.

For higher resolution, please use the schematic and layout attachment.

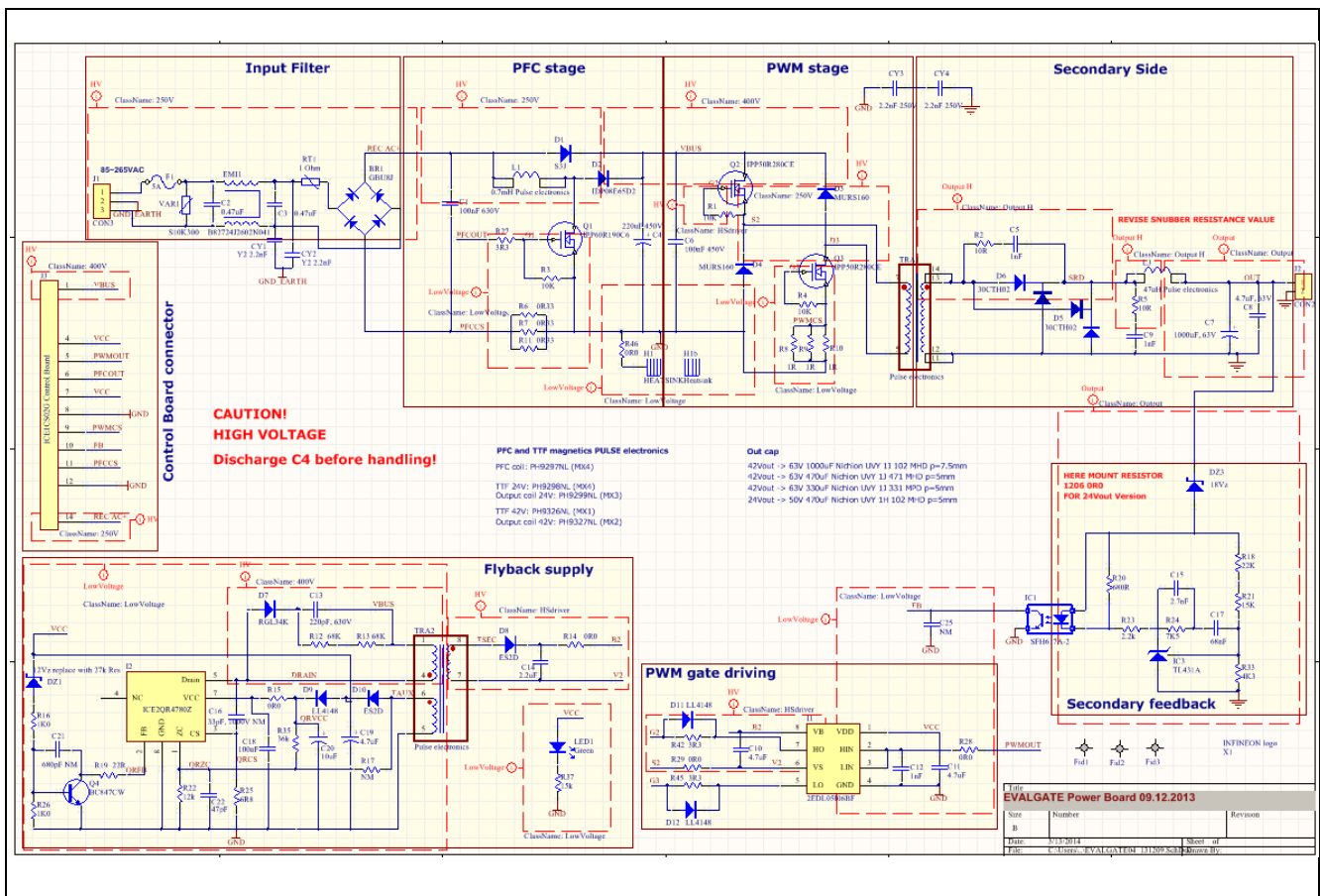

Figure 4 Power board schematic of 300 W SMPS Evaluationboard

300 W general purpose wide-range SMPS PFC + TTF Evaluation Board



System and board description

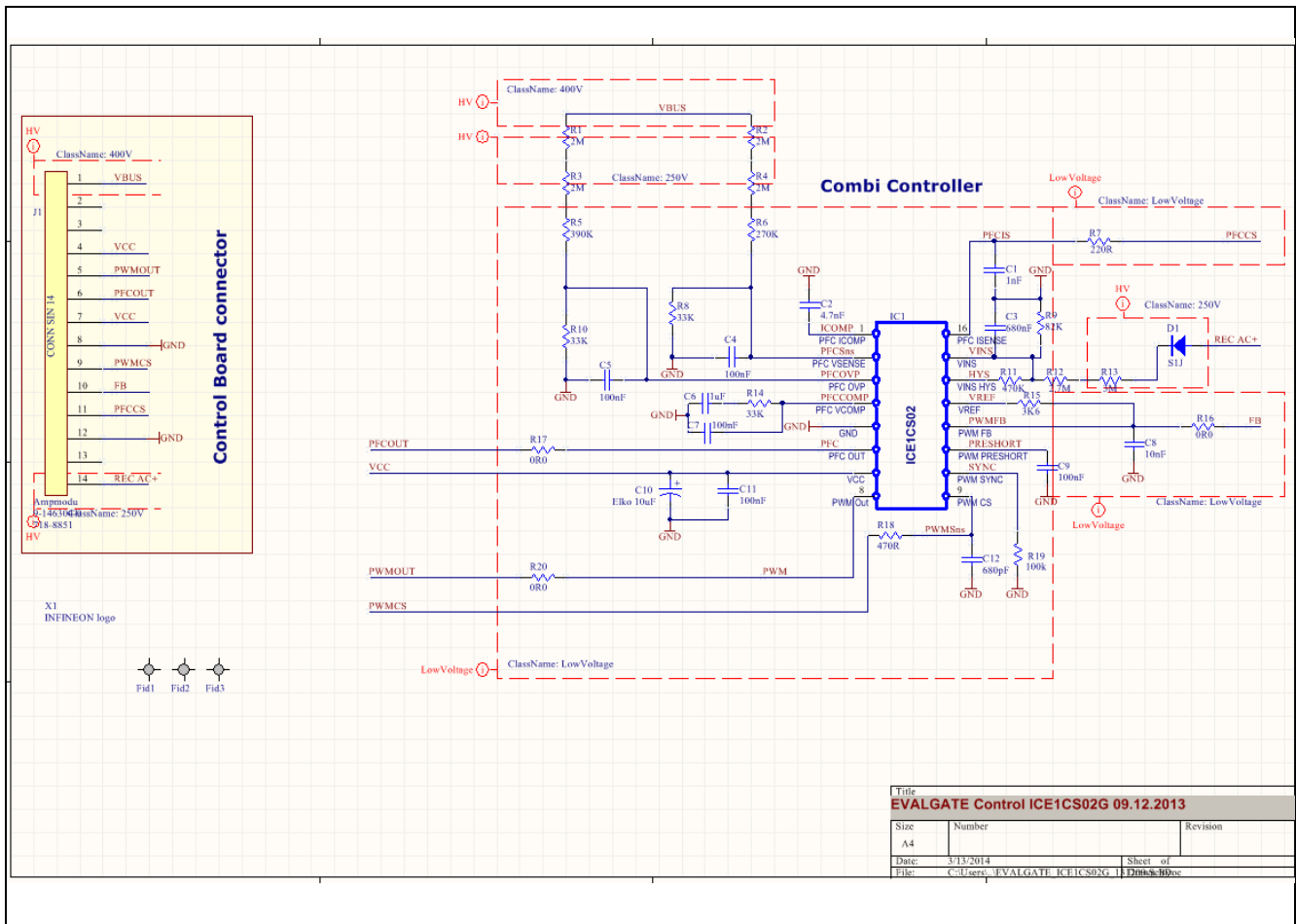

Figure 5 Control card schematic of 300 W SMPS Evaluationboard

2 AC line input filter and bridge

The input filter has been designed to cut common mode noise in the first hundreds kHz band. Highest available values X2 common mode capacitors (C2 and C3) have been equipped, consistently with the available board space. Differential mode noise filter is not implemented. Fuse protection and surge protection has been implemented close to the input connector. 5 Ω NTC (RT1) for inrush current limitation is provided.

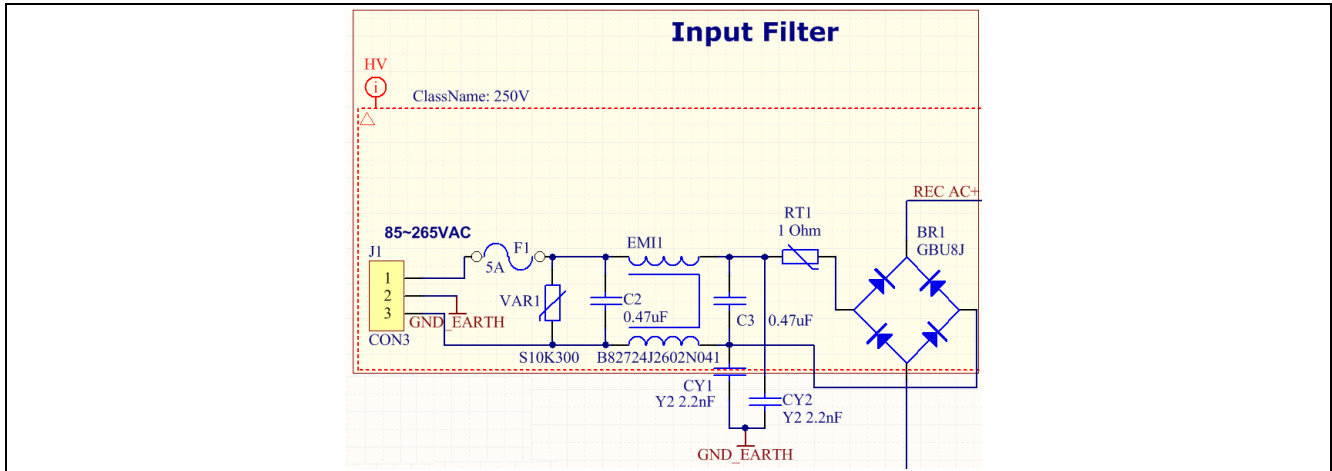

Figure 6 Input filter

2.1 Input filter layout

The filter layout should be as symmetrical as possible. A general rule recommends input filter in an orthogonal placement to other magnetics, in particular the PFC coil. Our proposal follows.

Connection of GND-Earth (Pin 2 of J1 connector) must be connected to metallic enclosure to reduce common mode noise. In case there is no enclosure, Y-caps (CY1 and CY2) have to be removed.

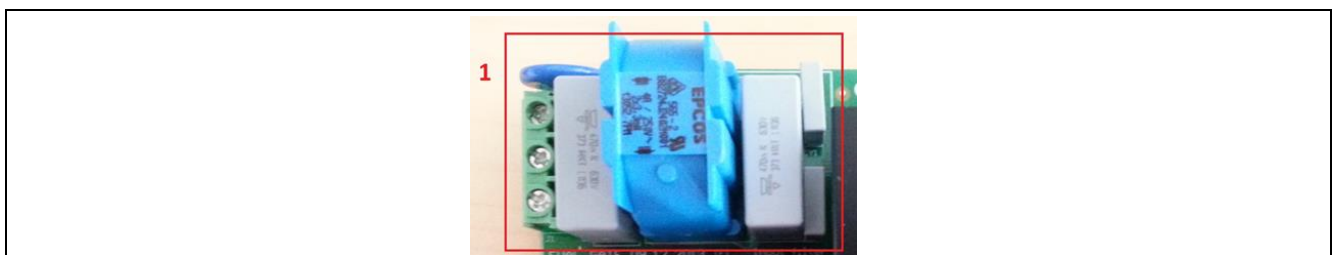

Figure 7 Input filter placement on board

Input filter is designed pragmatically in order to minimize conducted noise. Space and footprint for a bigger common mode choke is available as shown in Figure 8 .

When more than 2-layer board is used, the recommendation is to mount the Y-caps and extend the GND_EARTH shield plane on the bottom layer in order to couple the switching noise back to the power GND.

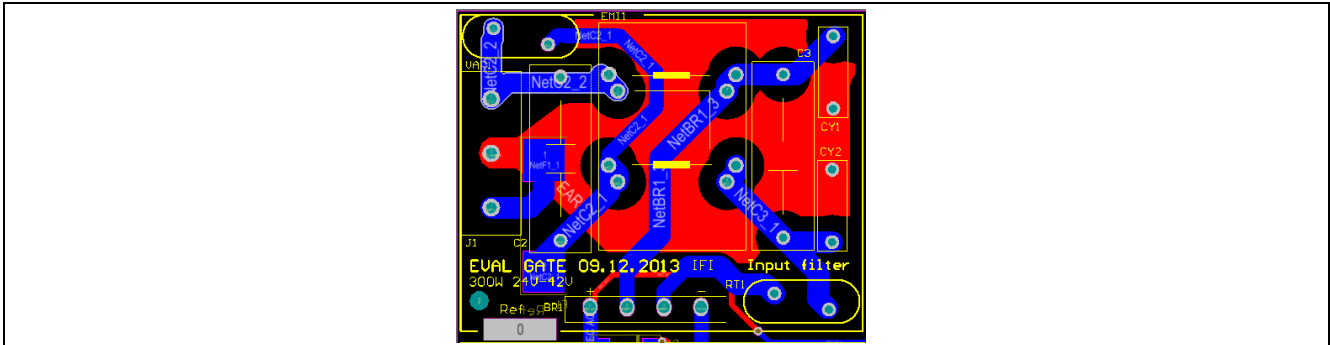

Figure 8 Input filter layout on proposed design

Please note that the fuse (FUSE1) to the surge suppressor (VAR1) net should be shortened in a better layout, in order to reduce the stray inductance path for very fast/high voltage surges from the net.

2.2 Input rectifier bridge

The proposed input bridge rectifier is a GBU8J, which is sized according to the power losses. The Power losses are calculated at maximum output power, 300 W, and minimum input voltage, 85 V_{AC} using simple assumptions.

We assume that efficiency is $\eta=85\%$, and forward voltage $V_F=0.85$ V, which is the value at 4 A_{DC}.

$$I_{IN (rms)} = \frac{P_{IN}}{V_{IN (rms)}} = \frac{P_{OUT} / \eta}{V_{IN (rms)}} = \frac{300 \text{ W} / 0.85}{85 \text{ V}} \sim 4.15 \text{ A} \quad \text{Eq 1}$$

$$P_{BR1} = 2 \cdot V_F \cdot I_{IN (rms)} = 2 \cdot 0.85 \text{ V} \cdot 4.15 \text{ A} = 7 \text{ W} \quad \text{Eq 2}$$

Heatsinking of input bridge is necessary. Average power consumption considering the power supply duty cycle of 5 min off/ 5 min on = 50% is 4.5 W, but temperature ripples depending on heatsink thermal inertia. With the provided heatsink, the temperature at bridge case rises up to 115°C.

Provided from GBU8J a $R_{th(j-c)}=4.0$ K/W, the junction temperature is close to 150°C at 7 W continuous load.

3 PFC stage

The controller provides a fixed frequency CCM PFC control algorithm. The PFC stage is designed to operate at 65 kHz, which is the standard operating frequency generated by the controller ICE1CS02G, mounted on the daughter board.

This frequency provides a compromise between inductor ripple and switching losses. Moreover keeps the 3rd harmonic of the PFC (190 kHz) in the 1st band of the conducted emissions (EMC).

Frequency can be changed by providing a synchronization signal at SYNC pin of the controller IC (see ICE1CS02G datasheet, SYNC pin section).

The PFC stage includes a pre-charge silicon diode (D1) which is recommended when D2 is a SiC diode, to avoid in-rush currents at hot NTC.

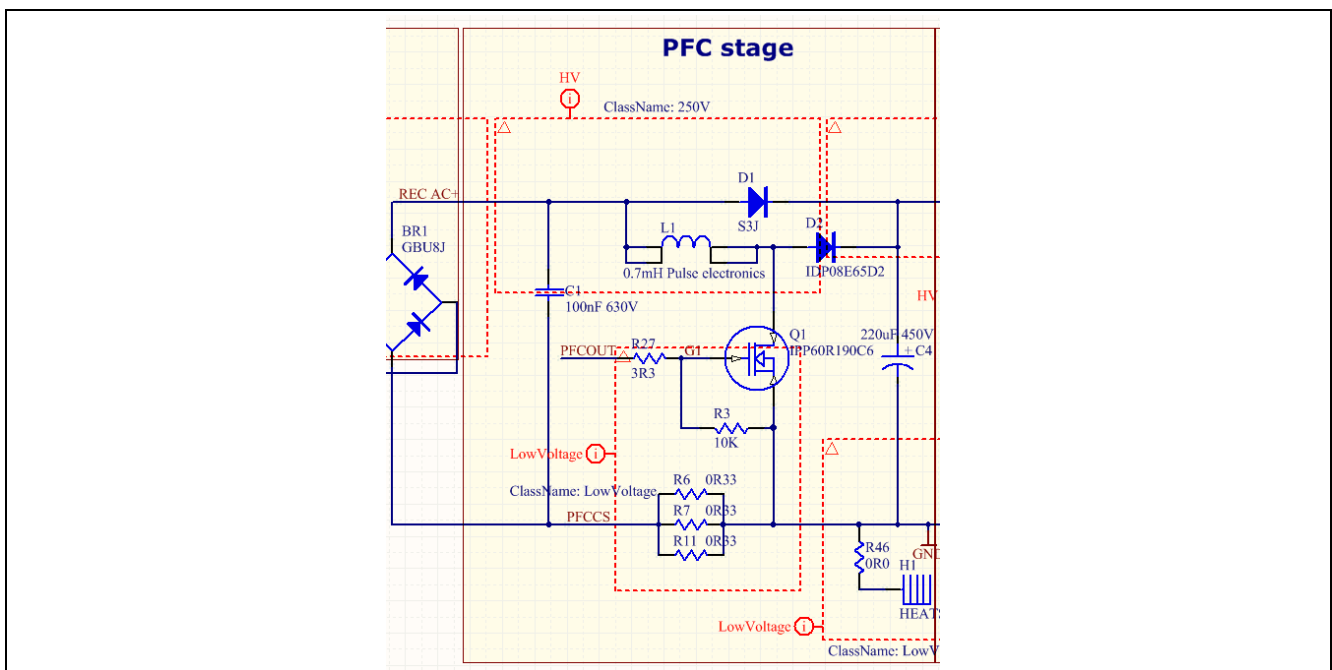

Figure 9 PFC stage schematic

3.1 PFC inductor design

PFC sizing is considered at maximum output power of 300 W and low line ($V_{AC,min} = 85 V_{AC}$), where input current is maximum.

L1 has then been chosen in order to reach a maximum current ripple of

$$\Delta I_{L1,max} = 20\% \cdot I_{L1,max}$$

Eq 3

Where $\Delta I_{L1,max}$ represents the current ripple and $I_{L1,max}$ represents the peak average inductor current in CCM mode.

Considering the following conditions:

- Input mains voltage: $85 V_{AC}$
- Input power: $300 \text{ W} / 85\% = 350 \text{ W}$

300 W general purpose wide-range SMPS PFC + TTF Evaluation Board



PFC stage

$$I_{L1,max} = \frac{P_{max} \cdot \sqrt{2}}{V_{in,min}} = \frac{350W \cdot \sqrt{2}}{85V_{AC}} = 5.82A_{pk} \quad \text{Eq 4}$$

Then $\Delta I_{L1,max} = 1.2 \text{ A}$ from **Eq 3**.

PFC inductance value can be derived from the simplified equation below.

$$\Delta I_{L1,max} = \frac{V_{BUS} - V_{in(rms)}}{L_1} \cdot t_{off} \quad \text{Eq 5}$$

$$\frac{V_{BUS}}{V_{in(rms)}} = \frac{1}{1 - D_{PFC}} \rightarrow L_1 = \frac{V_{BUS}}{f_{sw(PFC)} \cdot \Delta I_{L1,max}} \cdot D_{PFC} \cdot (1 - D_{PFC})$$

$$L1 = \frac{380 \text{ V}}{65 \text{ kHz} \cdot 1.2 \text{ A}} \cdot 0.5 \cdot (1 - 0.5) = 1.2 \text{ mH}$$

The PFC inductor is provided by PULSE Electronics (PH9297NL).

Specification follows in Figure 10.

UNLESS OTHERWISE SPECIFIED, TESTING IS PERFORMED AT 25 ±5°C.

PARAMETER	SPECIFICATIONS
OPERATING TEMP	-40°C ~ 125°C
POLARITY	PER SCHEMATIC
OCL	(4-2) = 1.24mH ±15% (100%, @ AT 100 KHz, 0.1 VRMS)
OCL+DC	(4-2) = 800 uH MIN (100%, @ AT 100 KHz, 0.1 VRMS, 4.6ADC)
DCR	(4-2) = 180.0 mOHMS MAX (SAMPLE)
SRF	(4-2) = 570KHz TYP (SAMPLE)

Figure 10 PFC inductor specification, from Pulse Electronics

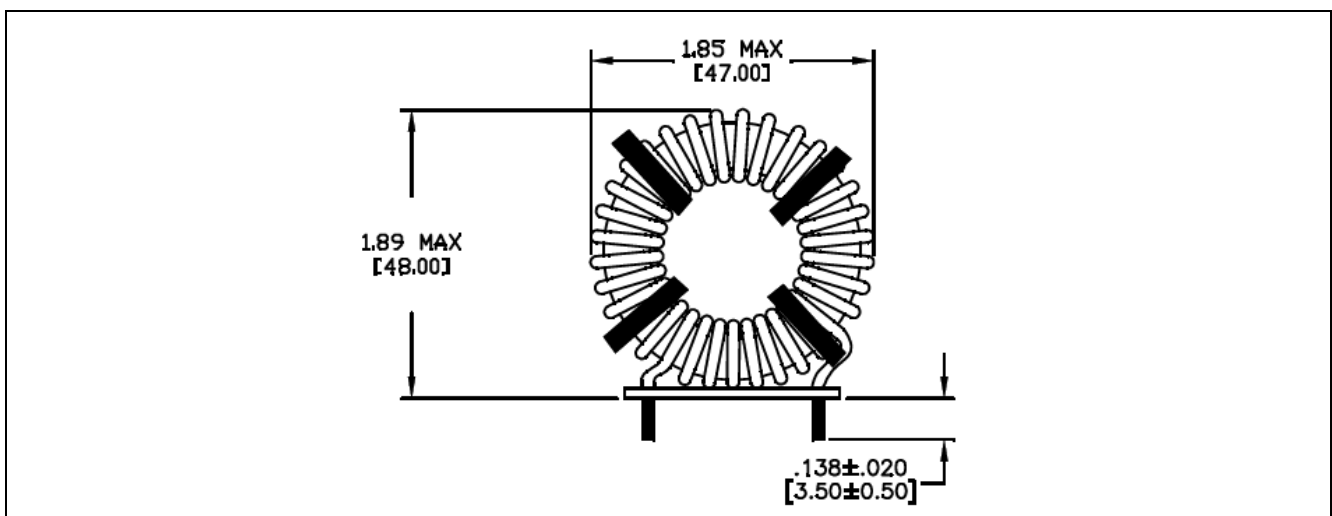

Figure 11 PFC inductor mechanical drawing (side)

PFC stage

As can be seen in Figure 11, the inductor design has been segmented in 4 sub-windings.

The segmentation is made to reduce inter-winding coupling, by keeping distance between turns which have high voltage difference. This minimizes stray inter-winding capacitance, which generates high frequency oscillations. In fact, current oscillations, superimposed on PFC-current, introduce high common mode noise at high frequency, which is quite difficult to remove with input filters. Current oscillations can be seen by measuring directly the inductor current. To see comparative measurement see chapter 7.

3.2 PFC MOSFET design

Active components choice relies on many different considerations, which are related in a very short summary to power dissipation, thermal design and efficiency.

In order to simplify the choice we start from considering the following conditions:

Table 3 Conditions for MOSFET losses calculation in PFC stage

Parameter	Value	Remarks
$T_{A,max}$	70°C	-
$R_{th(c-a)}$ (heatsink)	~15°C/W worst case	Heatsink size is chosen mainly due to space constraints
f_{sw}	65 kHz	Switching frequency
V_{bus}	380 V	DC bus voltage
V_{in}	85 V _{AC}	Input AC voltage
P_{in}	350 W	Considering 85% efficiency

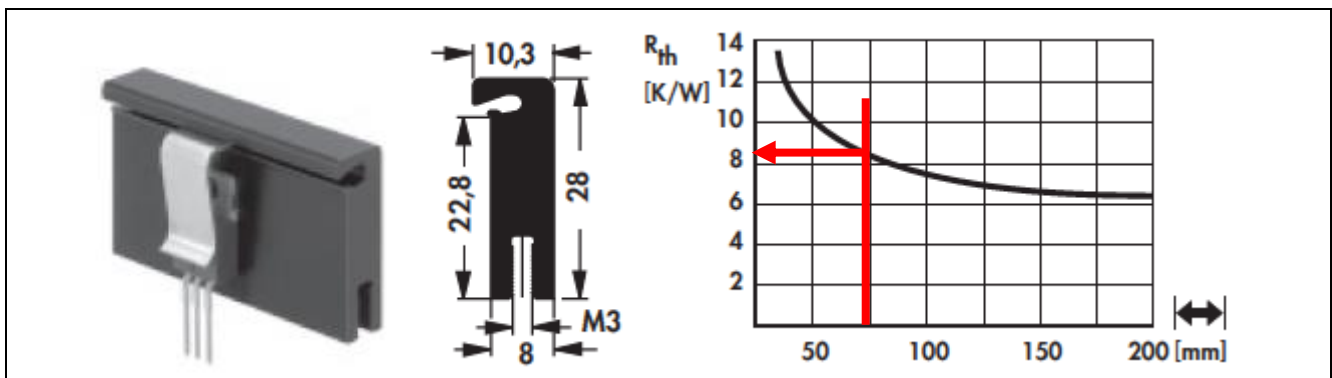
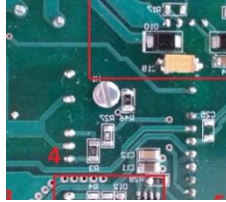

Figure 12 Heatsink choice (space constrained)

PFC main switch Q1 operates in hard switching in CCM, then resulting to high power losses during operation. MOSFETs with low Q_g , C_{oss} , E_{on} , and E_{off} are required to decrease the switching losses. Optimal $R_{DS(on)}$ for MOSFET selection has been evaluated by total power loss trade-off between conduction and switching losses, as explained in Chapter 11: Appendix B.



Attention: *The board is provided with heatsink connected to GND by a screw placed in the middle of the board on SMD side.*

GND is the 400 V negative reference, then, unless the mains voltage is insulated, the heatsink is then at high potential!

A 0 Ω resistor (R46) connects the heatsink from GND and can be removed.

The MOSFET current, which is considered for the plot is

$$\begin{aligned}
 I_{D(rms)Q1}^2 &= \frac{2}{T} \int_0^{\frac{T}{2}} D_{PWM}(t) \cdot I_{L1,max}^2(t) d(t) \\
 &= \frac{2}{T} \int_0^{\frac{T}{2}} \left(1 - \frac{V_{inpk} \cdot \sin(\omega t)}{V_{bus}}\right) \cdot I_{L1,max}^2 \cdot \sin^2(\omega t) d(t) \\
 &= \frac{1}{2} - \frac{4}{3\pi} \frac{V_{in,pk}}{V_{bus}} \cdot I_{L1,max}^2
 \end{aligned}
 \tag{Eq 6}$$

$$I_{D(rms)Q1} = I_{L1,max} \sqrt{\frac{1}{2} - \frac{4}{3\pi} \frac{V_{in,pk}}{V_{bus}}} = 5.82 \text{ A} \sqrt{\frac{1}{2} - \frac{4}{3\pi} \frac{85 \text{ V} \cdot \sqrt{2}}{380 \text{ V}}} = 3.55 \text{ A}$$

E_{oss} is a function of MOSFET drain voltage, which in CCM is output voltage V_{bus} .

Optimal on-resistance value then should be $R_{DS(on)opt} \sim 75 \text{ m}\Omega$, when $V_{IN(rms)} = 85 \text{ V}$ and $P_{IN} = 350 \text{ W}$ (worst case);

However, Q1 $R_{DS(on)}$ has been set to 190 mΩ considering a non-continuous load operation with 50% duty cycle between full load and low load conditions. In order to reduce the losses and allow full 100% duty load, a lower $R_{DS(on)}$ must be considered with the proposed heatsink design.

190 mΩ device provides additionally a good balance between performance and cost.

Figure 13 (described in Chapter 10: Appendix B), represents plots of losses in the power MOSFET as well as junction temperature. Chart shows total power losses are about 3 W with $R_{DS(on)Q1} = 190 \text{ m}\Omega$. Junction temperature rise will increase the effective $R_{DS(on)}$, by a factor of about 1.5, reaching higher junction temperature close to 140°C if steady state load is considered.

PFC stage

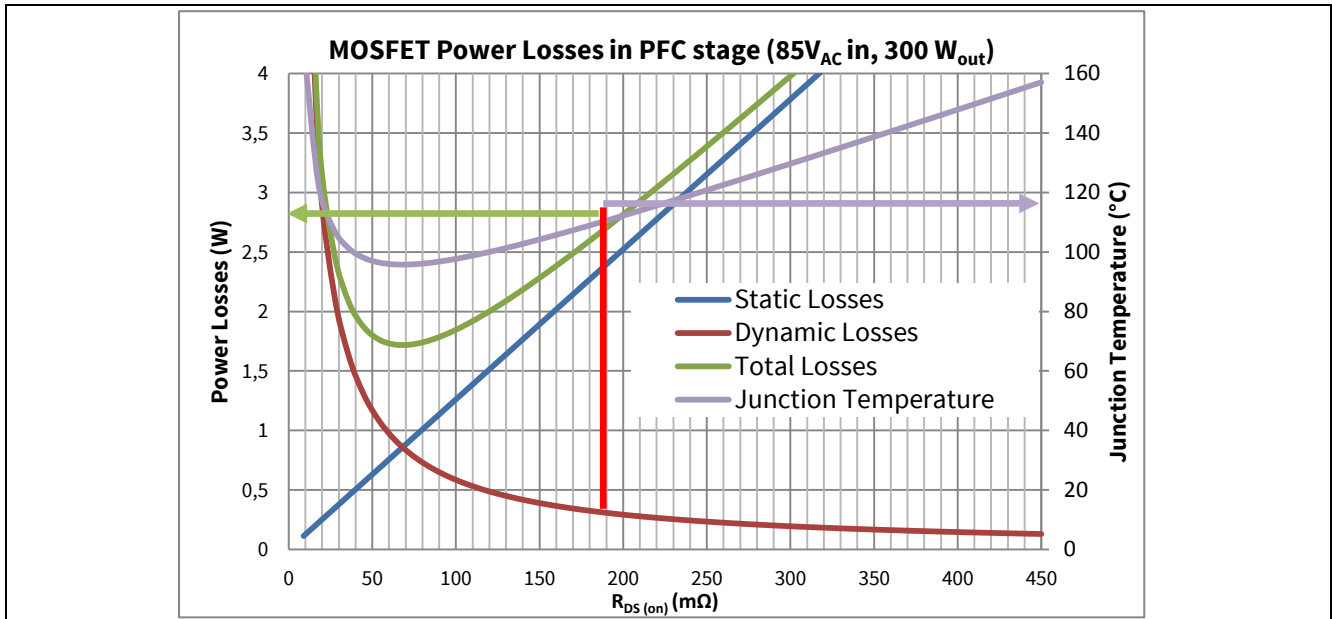

Figure 13 MOSFET losses plot for the PFC stage

MOSFET proposal is a **CoolMOS™ P6**, 190 mΩ (max) **IPP60R190P6**, which main parameters are shown in Table 4.

Table 4 Main Parameter of CoolMOS™ P6

Parameter		Value
$V_{(BR)DSS}$	Breakdown voltage @ ambient	600 V
R_G	Internal gate resistance	6 Ω
$R_{DS(ON)}$	Max R_{DS} @ ambient	190 mΩ
$C_{o(er)}$	Energy related output capacitance	56 pF
C_{oss}	Output capacitance	85 pF
$R_{th(j-c)} \text{ TO-220}$	Max junction-case thermal resistance TO-220	0.83 K/W

The above mentioned procedure to make a choice of the PFC MOSFET is simple and fast. It gives more a qualitative view than a real quantitative solution. Device need to be tested in the environment, in order to make the correct choice.

3.3 PFC Shunt resistor

Shunt resistor size is determined some constraints.

First is the overcurrent protection threshold determined by the controller.

The power board is designed for a shunt voltage threshold $V_{CSTH}=0,65$ V giving the following result:

$$R_{SHUNT_PFC} \leq \frac{|V_{CSTH}|}{I_{L1max} + \frac{\Delta i_{L1max}}{2}} = \frac{|V_{CSTH}|}{I_{L1max} + \frac{20\% \cdot I_{L1max}}{2}} = \frac{0,65 \text{ V}}{5,82 \text{ A}_{pk} \cdot (1,1)} = 101 \text{ m}\Omega \quad \text{Eq 7}$$

300 W general purpose wide-range SMPS PFC + TTF Evaluation Board



PFC stage

A second point to keep in mind is the power dissipation:

$$P_{SHUNT_PFC} = |V_{CSTH}| \cdot I_{D(rms)Q1} = 0,65 \cdot 3.55 A = 2,3 W$$



Eq 8

In order to fulfill both requirements, 3 shunt resistors of 330 mΩ in parallel have been used. The choice is on 1 W SMD resistors, type “2512” resistors to keep also low the stray inductance, which would cause spikes on the sensed voltage.

3.4 PFC diode design

PFC diode proposal is also important, and need some considerations. In particular, diode recovery in hard switching applications is an important parameter.

This design is a CCM PFC design, where diode recovery happens at almost every commutation period when in high load conditions.

Recovery generates high current spikes that create

- High frequency commutation noise that generates conducted common mode noise at mid/hi- frequency
- High amplitude spikes in the MOSFET channel during turn-on. Spikes have to be filtered by a leading edge blanking filter from the controller (usually always present). This current creates additional losses in the MOSFET, flowing through the channel at turn-on

The output power of the proposed converter is such that a small SiC diode can be used. Here we have chosen a 3 A device in 5th **Generation thinQ!**™ technology: **IDH03G65C5**.

Table 5 IDH03G65C5 summary of parameters. Please refer to component datasheet for details

Parameter		Value
V_{RRM}	Repetitive peak reverse voltage	650 V
I_F	Continuous forward current	3 A
$I_{F(max)}$	Non-repetitive peak forward current	178 A
V_F	Diode forward voltage @ ambient	1.5 VpF
Q_c	Total capacitive charge	5 nC
$R_{th(j-c)}$ TO-220	Max junction-case thermal resistance TO-220	3.6 K/W

3.5 PFC capacitor design

PFC bulk capacitor is designed according to required hold-up time. The requirement is usually to keep a minimum voltage of 340 V for 20 ms line drop at maximum output power.

Assuming a constant discharge of the bulk capacitor, Eq 9 can be applied to calculate the minimum Capacitance required.

$$\frac{1}{2} C_{bulk} (V_{bus}^2 - V_{bus,min}^2) \geq P_{out,max} \cdot \Delta t \rightarrow C_{bulk} \geq \frac{300 W \cdot 20 ms}{380^2 V - 340^2 V} = 208 \mu F \quad \text{Eq 9}$$

Bus capacitor is a 220 μF, 450 V electrolytic, with additional 100 nF high frequency film cap bypass.

4 TTF Stage

The controller provides a fixed frequency forward current mode control algorithm. The gating output PWM OUT can be used to drive directly a single MOSFET for a Single Transistor Forward design, or, alternatively, can drive a Gate Driver IC in order to drive a Two Transistor Forward topology.

The switching frequency is 130 kHz, high enough to reduce the size of magnetic components (TTF transformer as well as output inductors) and keep reduced switching losses.

Frequency can be changed by providing a synchronization signal at SYNC pin of the controller IC (see ICE1CS02G datasheet, SYNC pin section).

The TTF stage can be split into primary side (left hand-side of Figure 14) and secondary (insulated) side (right-hand side of Figure 14).

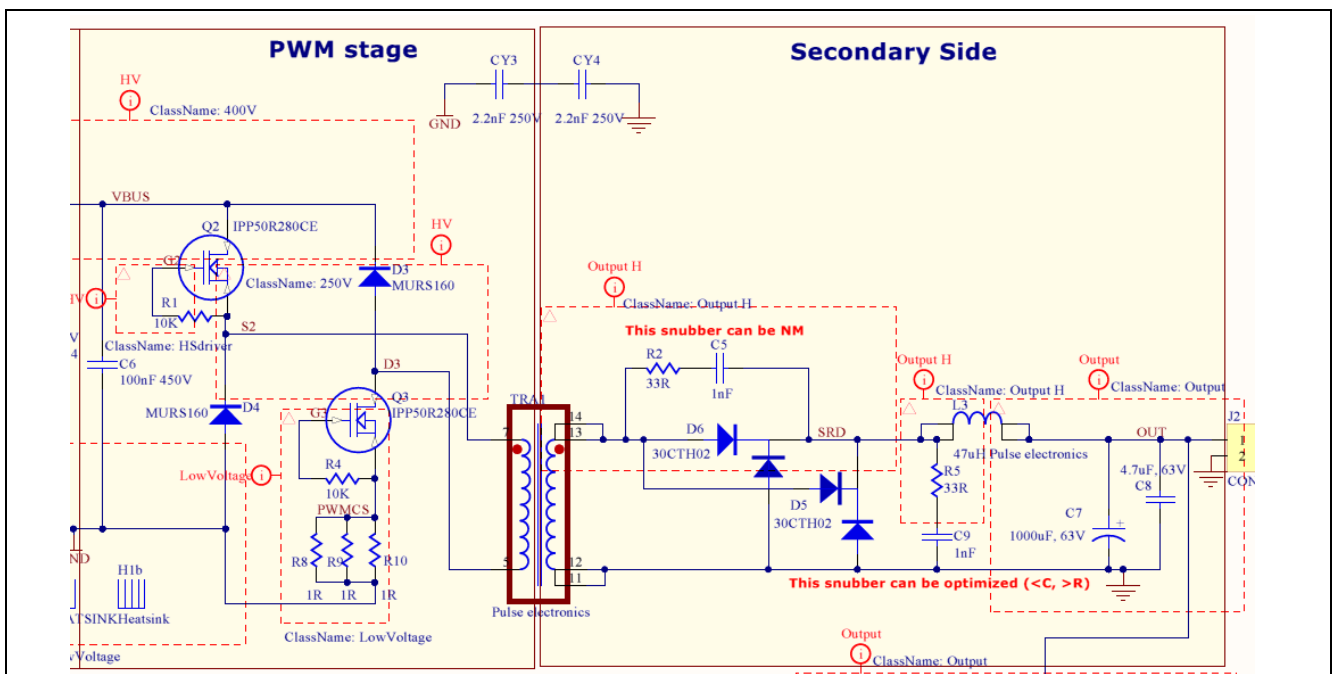

Figure 14 TTF stage. Primary and secondary side

4.1 TTF primary side

On primary side, the bulk voltage Vbus is controlled by the former PFC stage to 380 V typ. In order to reduce solution cost, but still with a good safety margin on MOSFETs breakdown voltage, the decision is to use 500 V devices.

500 V CoolMOS™ CE is the perfect fit, with best switching performance / system cost ratio.

The two sides of the TTF stage are analyzed in the following chapters.

4.1.1 TTF transformer

In order to size the transformer for a 42 V output starting from 380 V bulk voltage, we must consider the maximum duty cycle limit of 50%. Allowing margin for step load response, typical working duty cycle is set to 40%. Moreover, the higher the duty cycle is, the lower will be the secondary side output of the transformer.

300 W general purpose wide-range SMPS PFC + TTF Evaluation Board



TTF Stage

Ideally V_{out} and V_{bus} are linked by the following Eq 10.

$$\frac{V_{out}}{V_{bus}} = \frac{N_{sec}}{N_{prim}} \cdot D_{pwm} \quad \text{Eq 10}$$

$$\frac{N_{sec}}{N_{prim}} = \frac{V_{out}}{V_{bus} \cdot D_{PWM}} = \frac{42 V}{380V \cdot 0.4} = \frac{1}{3.62} \quad \text{Eq 11}$$

Transformer primary inductance LTRA1 value has been set in order to ensure enough magnetizing current to properly set / reset the core. During the primary-side turn-on period, the magnetizing inductance is charged by a current I_{MAG} which must be reset during the turn-off time. I_{MAG} peak is set to about 400 mA in order to keep small the recirculation diodes and limit the recirculation current which creates EMI current loops. 1 A fast-diodes D3 and D4 are used.

$$L_{TRA1} \geq \frac{V_{BUS}}{I_{MAG}} \cdot \frac{D_{PWM}}{f_{sw(PWM)}} = \frac{380 V}{400 mA} \cdot \frac{0,4}{130 kHz} = 2,9 mH \quad \text{Eq 12}$$

Specification from magnetics manufacturer follows on Figure 15 where primary side inductance is higher and allows lower values of I_{MAG} .

The choice is on Pulse Electronics (PH9326NL), which is a transformer without shield. Shield design for the transformer was not studied in details, but it might be necessary in certain cases.

UNLESS OTHERWISE SPECIFIED, TESTING IS PERFORMED AT 25 ±5°C. TURNS RATIO LIMITS ARE SPECIFIED AS MEASURED WITH UNGAPPED CORES.	
PARAMETER	SPECIFICATIONS
OPERATING TEMP	-40°C ~ 125°C
POLARITY	PER SCHEMATIC
TURNS RATIO	(7'-5) : (13,14'-11,12) = 3.81 ±2% (100%, @AT 100 KHz, 0.1 VRMS)
INDUCTANCE	(5-7) = 3.0 mH ±15% (100%, @ AT 100 KHz, 0.1 VRMS)
LEAKAGE INDUCTANCE	(5-7) WITH 11,12,13,14 SHORTED = 11uH TYPICAL (100%, @ AT 100 KHz, 0.1 VRMS)
DCR	(5-7) = 230mOHMS TYPICAL (SAMPLE)
	(11,12-13,14) = 27.0mOHMS TYPICAL (SAMPLE)
HIPOT	(5,7) TO (11,12,13,14) = 4.0K VAC FOR 1 MINUTE OR 4.5K VAC, FOR 6 S (100%)
	ALL PINS TO CORE = 2.0K VAC FOR 1 MINUTE OR 2.2K VAC, FOR 6 S (100%)

Figure 15 TTF transformer specification 42 V, from Pulse Electronics

Primary side current derives from choice of secondary side current ripple.

The choice is done in such a way that at 15% load the output stage is in Boundary Condition Mode, which means the ripple current touches zero at the end of each cycle. Then, in order to have an output current ripple of about 30% of the maximum load current, ripple current is calculated from Eq 14:

$$I_{o(avg)} = \frac{P_{out}}{V_{out}} = \frac{300 W}{42 V} = 7.15 A \quad \text{Eq 13}$$

$$I_{ripple} = 30\% \cdot I_{o(avg)} = 30\% \cdot 7.15 A = 2.2 A \quad \text{Eq 14}$$

4.1.2 TTF Primary side MOSFETs

To size the primary side components, the primary side currents have to be calculated. The following equations show how to calculate the most important currents of the primary side used to size the switches.

$$I_{MAG} = \frac{V_{BUS}}{L_{TRA1}} \cdot \frac{D_{PWM}}{f_{sw(PWM)}} = \frac{380 V}{3,5 mH} \cdot \frac{0,4}{130 kHz} = 334 mA$$

Magnetizing current **Eq 15**

$$I_{MOS(sec_min)} = I_{o(min)} \cdot \frac{N_{sec}}{N_{prim}} = 6.05 A \cdot \frac{1}{3.59} = 1.68 A$$

Load current seen by primary side **Eq 16**

$$I_{MOS(sec_max)} = I_{o(max)} \cdot \frac{N_{sec}}{N_{prim}} = 8.25 A \cdot \frac{1}{3.59} = 2.3 A$$

$$I_{MOS(max)} = I_{MOS(sec_max)} + I_{MAG} = 2.63 A$$

Primary MOS peak current **Eq 17**

$$I_{MOS(rms)} = \sqrt{\frac{I_{MOS(max)}^2 + (I_{MOS(sec_min)} + I_{MAG})^2 + I_{MOS(max)} \cdot (I_{MOS(sec_min)} + I_{MAG})}{3}}$$

MOS rms current **Eq 18**

$$= 2 A$$

The following Figure 16 shows the naming conventions used.

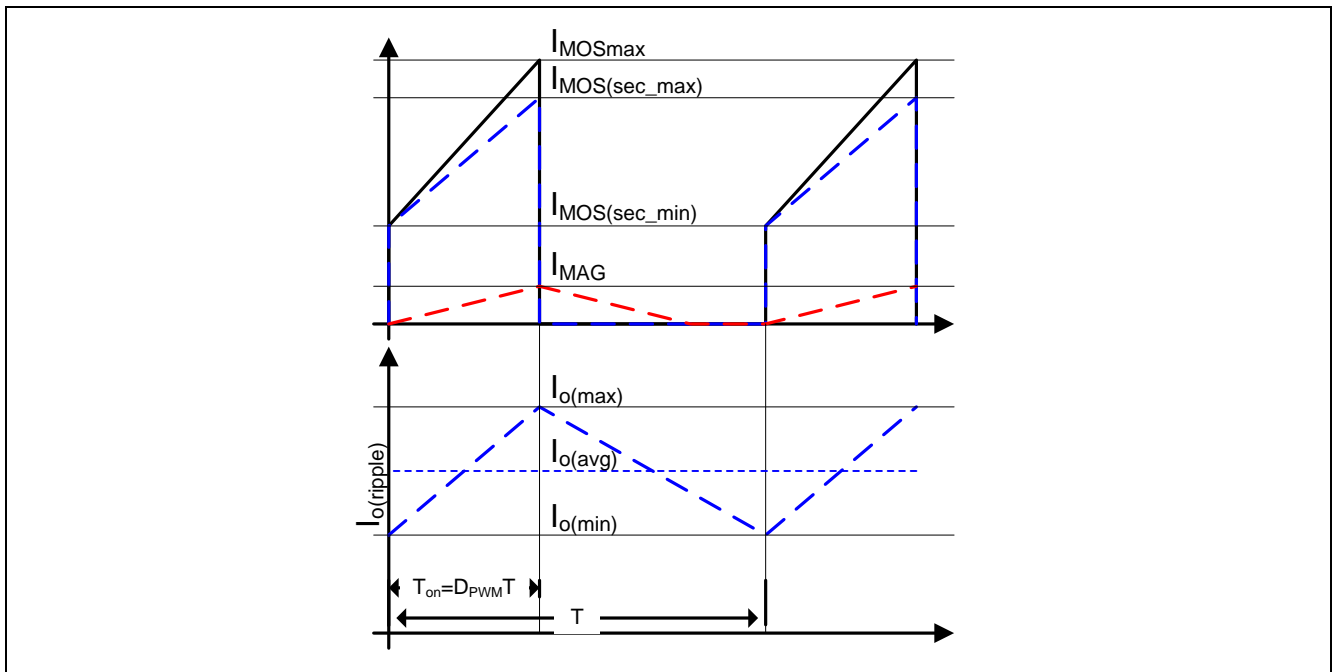

Figure 16 Current shapes on primary MOSFET (I_{MOS}) and output inductor (I_o)

As well as for the PFC, for the TTF stage, MOSFETs Q2 and Q3 work in hard switching, and then selection criteria are the same as in the PFC stage: low Q_g , C_{oss} , E_{on} , and E_{off} are required to decrease switching losses. We are going to use the same graphical procedure as or the PFC.

TTF Stage

The chart shown in Figure 17 points out the power losses of the TTF MOSFETs, showing that a minimum can be found with $R_{DS(on)} = 125\text{ m}\Omega$. For a better cost/performance compromise the decision falls on a 280 m Ω (max) device, like the **IPP50R280CE**, which still shows a good thermal behavior and acceptable losses.

Estimated losses for each MOSFET are about 1.5 W, which may reach some above 2 W in hot conditions. Still Junction temperature is far below 150°C.

As well as in the case of the PFC MOSFET, the chart provides qualitative rather than quantitative information of the power losses. Nevertheless, the provided indications demonstrated a good matching with the hardware.

Please refer to chapter 11: APPENDIX B for notes on calculation of the mentioned charts.

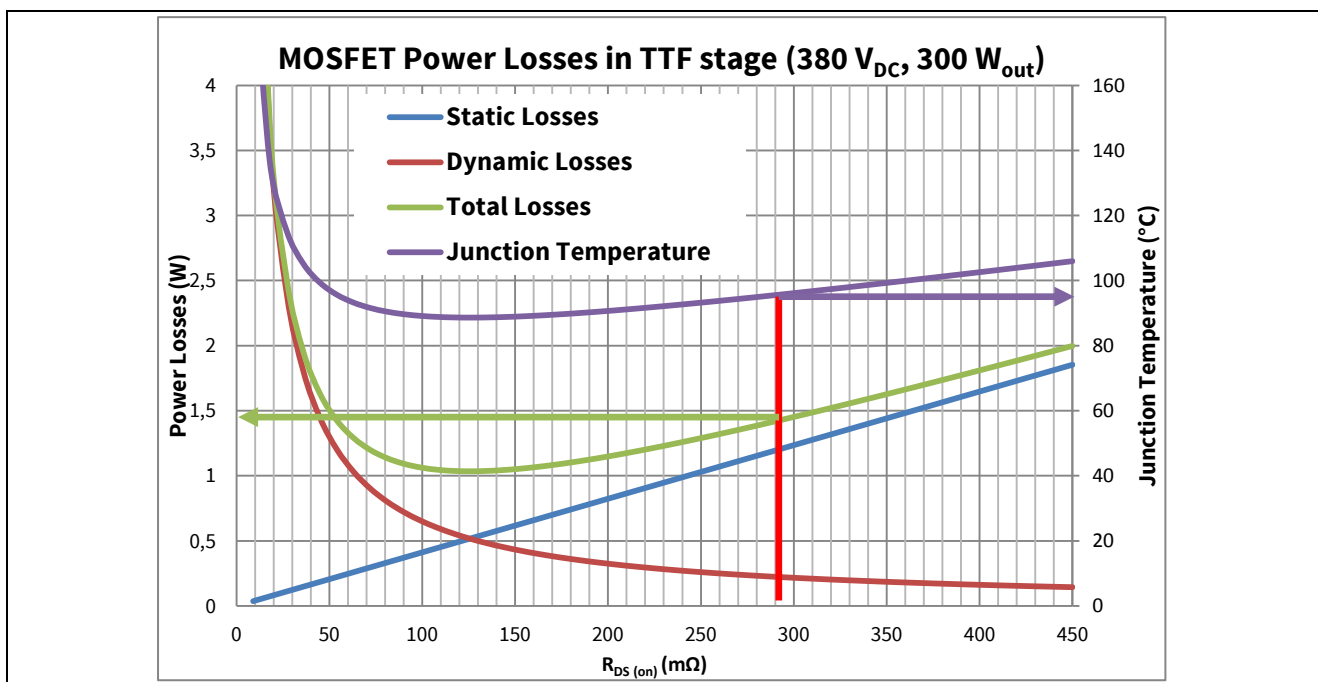

Figure 17 MOSFET power losses for the TTF stage

Here below are listed the environment conditions used to plot the chart.

Table 6 Conditions for MOSFET losses calculation in TTF stage

Parameter	Value	Remarks
$T_{A,max}$	70°C	-
$R_{th(c-a)}$ (heatsink)	~15°C/W worst case	Heatsink choice from space constraints Value considers that the heatsink is shared and a multiplication factor 1.5 for non-ideal mounting, vs datasheet value in Figure 12.
f_{sw}	130 kHz	Switching frequency
V_{bus}	380 V	DC bus voltage, at switch-on half V_{bus} is applied
P_{in}	350 W	Considering 85% efficiency

TTF Stage

MOSFET proposal is a **CoolMOS™ CE**, 280 mΩ (max) **IPP50R280CE**, which main parameters are shown in Table 7.

Table 7 IPP50R280CE summary of parameters. Please refer to component datasheet for details

Parameter		Value
$V_{(BR)DSS}$	Breakdown voltage @ ambient	500 V
R_G	Internal gate resistance	3 Ω
$R_{DS(ON)}$	Max R_{DS} @ ambient	280 mΩ
$C_{o(er)}$	Energy related output capacitance	40 pF
C_{oss}	Output capacitance	49 pF
$R_{th(j-c)}$ TO-220	Max junction-case thermal resistance TO-220	1.36 K/W

A note shall be pointed out for the choice of the freewheeling diodes D3 and D4.

Note: Even though the magnetization current I_{MAG} they bring may appear small, and the switch off smoothly (ZCS) it is important that the choice falls on fast reverse recovery diodes. D3 and D4 are MURS160.

Note: Layout design of TTF is not easy, and demagnetization path is usually longer than main path. This path is partially responsible for emissions and must be carefully studied, starting for the device choice. Layout of the board described in this application note, is unfortunately not perfectly optimized in this path.

4.1.3 TTF shunt resistor

Same procedure as for the PFC stage has been taken for the TTF shunt resistor choice.

The power board is designed for a shunt voltage threshold $V_{csth}=1$ V giving the following result:

$$R_{SHUNT_TTF} \leq \frac{|V_{CSTH}|}{I_{MOS(max)}} = \frac{1\text{ V}}{2,63\text{ A}_{pk}} = 380\text{ m}\Omega \quad \text{Eq 19}$$

A second point to keep in mind is the power dissipation:

$$P_{SHUNT_TTF} = |V_{CSTH}| \cdot I_{MOS(rms)} = 1\text{ V} \cdot 2\text{ A} = 2\text{ W} \quad \text{Eq 20}$$



In order to fulfill both requirements, and to keep some flexibility, 3 shunt resistors of 1 Ω in parallel have been used. The choice is on 1 W SMD resistors, type “2512” to keep also low the stray inductance, which would cause spikes on the sensed voltage.

4.1.4 MOSFET gate driving

The gate driving of the TTF power MOSFETs is done using an Infineon EiceDRIVER™ gate driver IC **2EDL05106BF**. The gate driver IC is a non-interlocking driver, so that high side and low side can be turned-on simultaneously, which is necessary in a TTF topology.

300 W general purpose wide-range SMPS PFC + TTF Evaluation Board



TTF Stage

The gate driving section is shown in Figure 18, where input of the IC is “PWMOUT” (which comes from the control board) and G3, G2, S2 represent respectively the low-side MOSFET gate and the high-side MOSFET gate and source.

D11 and D12 are optional turn-off paths and can be removed. There is no Miller induced turn-off effect in TTF, since both MOSFETs are turned on simultaneously. Turn-on can be soft, since the topology allows zero load current switching and only capacitive spike take place at turn-on.

Trimming on gate driving resistance are mainly related to a compromise between switching behavior and high frequency oscillations that may be induced by layout problems.

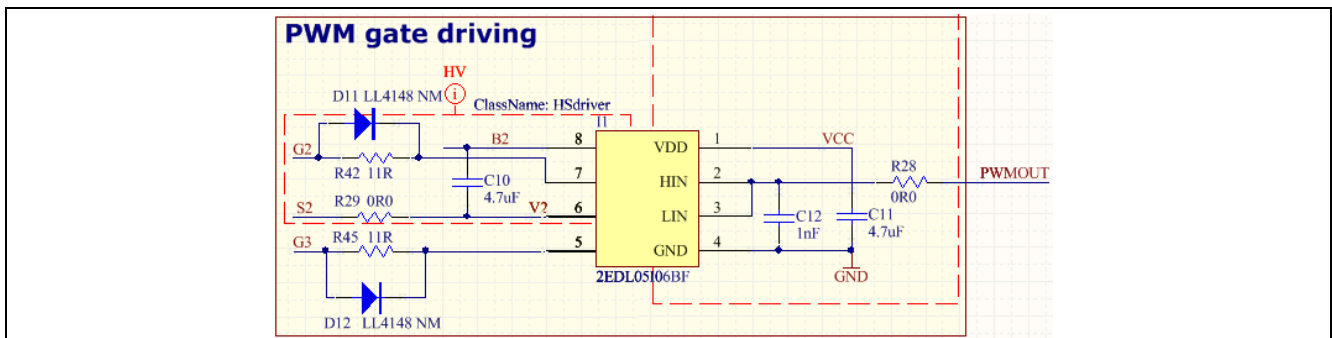

Figure 18 Gate driver IC schematic

The use of a gate driver versus a pulse transformer (widely used in this topology), is the capability to control and keep well above the threshold voltage the gate of the MOSFETs, allowing a safe driving in all supply conditions.

Especially in case of failures or difficult layout situations, the gate driver IC solves grounding problems and helps placing the drive buffers closer to the MOSFETs to be controlled. In this power supply the choice of a gate driver IC solution pairs with the use of a controller daughterboard, where there may be different kind of controllers.

Moreover it avoids the typical effect of pulse transformers, where there can be an effect of offset shifting of the gate driving signals, which is dependent on duty cycle as shown in the following picture.

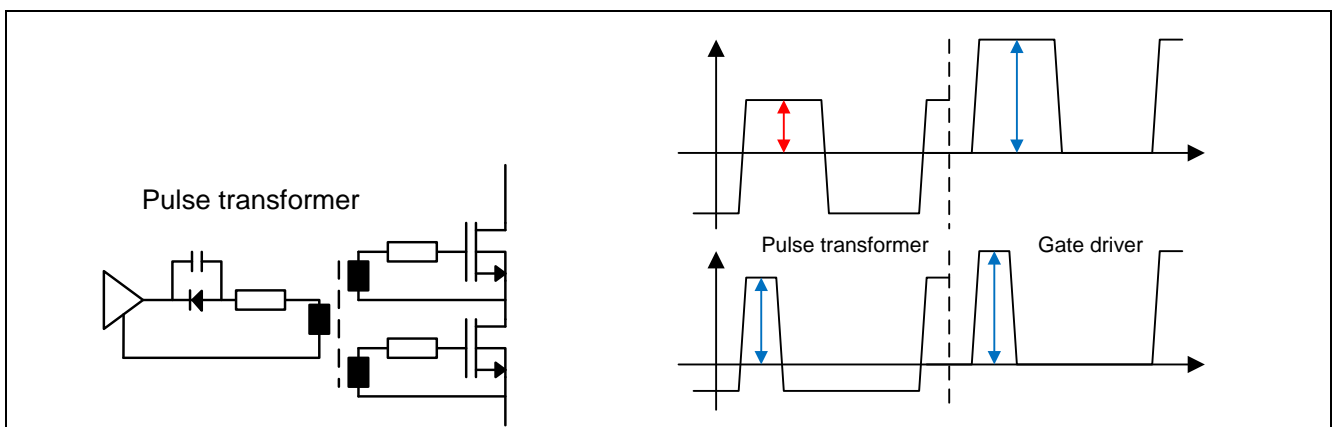

Figure 19 Typical offset shifting when using pulse transformer

Please note that the bootstrap supply cannot be applied to TTF topology to supply the hi-side buffer. Auxiliary power supply is necessary.

4.2 TTF secondary side

Secondary side schematic is shown in Figure 20.

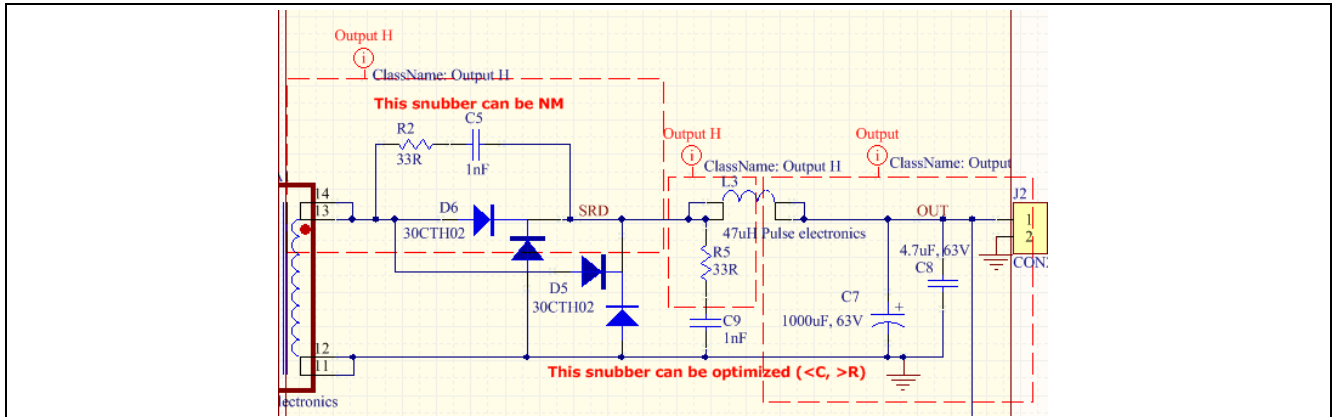

Figure 20 TTF secondary side schematic

4.2.1 TTF rectifier diodes

Secondary output voltage V_{SEC} is then rectified by Schottky Barrier Rectifier $D5$ and $D6$ (30CTH02PBF): diodes in common cathode configuration, having then a rectifier (in series with the transformer) and a freewheeling path. Synchronous rectification (SR) could also be available with two MOSFETs for power loss reduction with an external driver.

Two snubber protections are also present ($R2 - C5$ and $R5 - C9$), in order to reduce inductor $L3$ overvoltage and dump the oscillations. $R2 - C5$ in particular are redundant and can be used for testing.

RC pole should be located in the 10 ... 50 MHz range, and have to be trimmed as a function of snubbing effect, by watching at the waveforms across the diodes.

Diodes theoretical reverse voltage V_{SRD} is derived from the following **Eq 21**:

$$V_{SRDmax} = \frac{V_{out}}{D_{PWM}} = \frac{42 V}{0.4} = 105 V \quad \text{Purely theoretical value} \quad \text{Eq 21}$$

But the equation doesn't take into account the spikes and overshoots due to stray components.

The board is equipped with 200 V diodes, and the measured peak voltage at maximum load gets repetitively voltages up to 160 V for few nanoseconds, with the proposed snubbers.

Output diodes are one of the main source of losses and shottky diodes are necessary. A second and equally important characteristic of the diode is the switching behavior, which has to be ultrafast and smooth. Several kind of diodes has to be proven before a final choice, because the switching behavior strongly influences the primary side, through the transformer and the conducted and emitted noise.

Rectifier diode losses are due to secondary current I_{SEC} (avg). For rough estimation of power losses for the secondary side, it might be considered the following chart and calculation at peak output power:

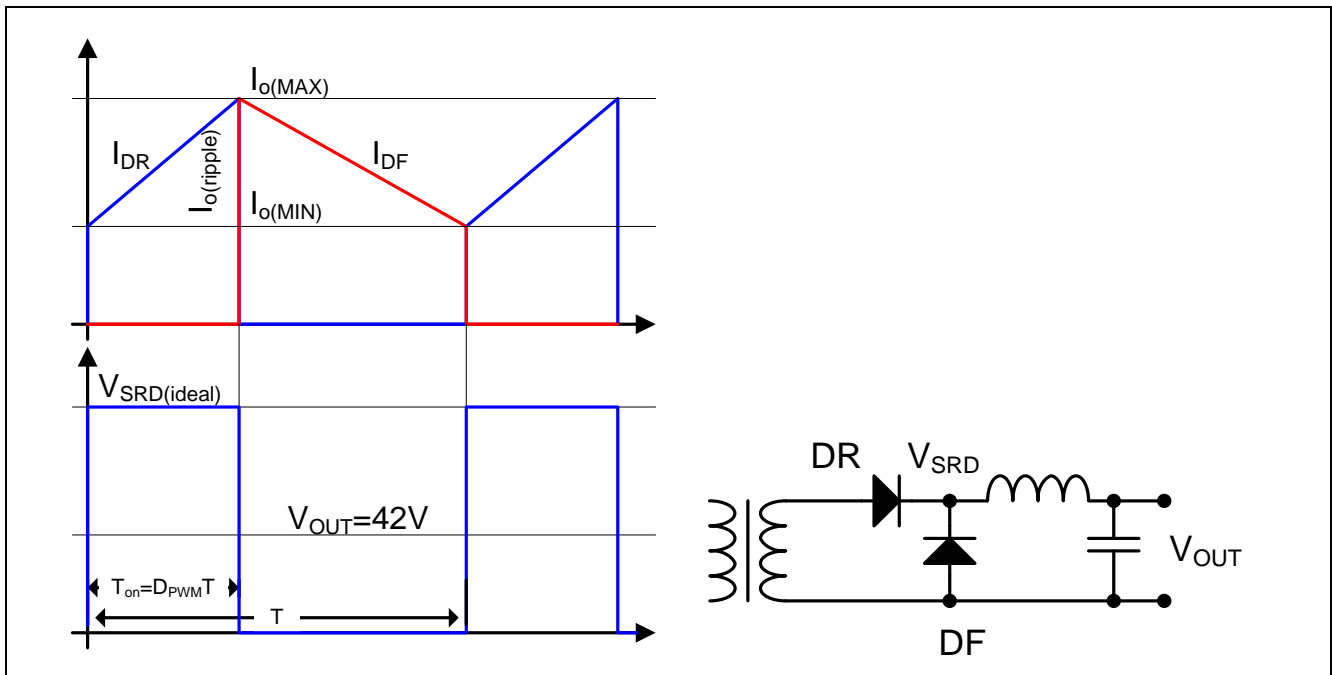

Figure 21 Output ideal waveforms and circuit

$$P_{DR} = V_F \cdot I_{DR(avg)} = 0.65 \text{ V} \cdot \sqrt{\frac{0.4 \cdot (6.05^2 + 6.05 \cdot 8.25 + 8.25^2)}{3}} \text{ A} = 0.65 \text{ V} \cdot 4.54 \text{ A} = 2.95 \text{ W} \quad \text{Eq 22}$$

$$P_{DF} = V_F \cdot I_{DF(avg)} = 0.65 \text{ V} \cdot \sqrt{\frac{0.6 \cdot (6.05^2 + 6.05 \cdot 8.25 + 8.25^2)}{3}} \text{ A} = 0.65 \text{ V} \cdot 5.56 \text{ A} = 3.61 \text{ W} \quad \text{Eq 23}$$

Calculation of diodes average currents in **Eq 22** and **Eq 23** follow examples in Chapter 9: APPENDIX A.

The calculation takes into account only the conduction losses.

A very rough estimation of diode switching losses can be done considering the datasheet value of $Q_{rr}=120 \text{ nC}$ @ 125°C vs reverse commutated voltage $V_{SRD}=105 \text{ V}$ at $f_{sw}=130 \text{ kHz}$, which gives about $P_{DSW}=1.64 \text{ W}$ additional per diode.

The power board hosts space for mounting two pairs of common cathode diodes.

In order to allow power dissipation for the diodes in continuous load conditions can be done the following estimation for the required heatsink $R_{thja} = R_{thjc} + R_{thca}$:

$$R_{THja} < \frac{T_j - T_a}{P_D} = \frac{T_j - T_a}{P_{DR} + P_{DF} + 2 \cdot P_{DSW}} = \frac{150^\circ\text{C} - 70^\circ\text{C}}{2.95 \text{ W} + 3.61 \text{ W} + 2 \cdot 1.64 \text{ W}} = 8^\circ\text{C/W} \quad \text{Eq 24}$$

4.2.2 TTF output passives

Design for LC output inductor and capacitor tank starts from the assumption that the entire ripple component in inductor current ΔI_{L3} flows through C7, while its average component flows through the load. During off-time $t_{off(PWM)} = (1 - D_{PWM}) \cdot T_{sw(PWM)}$, inductor ripple current is:

$$\Delta I_{L3max} = \frac{V_{out}}{L_3} \cdot (1 - D_{PWM}) \cdot T_{sw} = \frac{V_{out}}{L_3} \cdot \frac{(1 - D_{PWM})}{f_{sw(PWM)}} \quad \text{Eq 25}$$

and the output inductor is calculated as follows:

$$L_3 = \frac{V_{out}}{\Delta I_{L3max}} \cdot \frac{(1 - D_{PWM})}{f_{sw(PWM)}} = \frac{42 V}{2.2 A} \cdot \frac{(1 - 0.4)}{130 kHz} = 88 \mu H \quad \text{Eq 26}$$

The output inductor was manufactured by **Pulse Electronics (PH9327NL)**, as well. The core is toroidal and specification from manufacturer follows in Figure 22:

UNLESS OTHERWISE SPECIFIED, TESTING IS PERFORMED AT 25 ±5°C.	
PARAMETER	SPECIFICATIONS
OPERATING TEMP	-40°C ~ 125°C
POLARITY	PER SCHEMATIC
OCL	(1-3) = 121.0 uH ±15% (100%, @ AT 100 KHz, 0.1 VRMS)
OCL+DC	(1-3) = 80 uH MIN (100%, @ AT 100 KHz, 0.1 VRMS, 8ADC)
DCR	(1-3) = 19.0 mOHMS MAXIMUM (SAMPLE)

Figure 22 Output inductor specification, from Pulse Electronics

To find an indication about sizing the output capacitor, the output voltage ripple must be fixed. Let's start fixing $\Delta V_{out} = 0.01\% \cdot V_{out} = 40 \text{ mV}$. Then let's consider that the inductor current charges and discharges by $\pm \Delta Q$ the output capacitor, so that the output ripple can be calculated as follows:

$$\Delta V_{out} = \frac{\Delta Q}{C} = \frac{1}{C} \cdot \left(\frac{\Delta I_{L3} \cdot T_{sw(PWM)}}{8} \right) \quad \text{Eq 27}$$

Replacing ΔI_{L3} from **Eq 25** the relative ripple can be obtained as:

$$\frac{\Delta V_{OUT}}{V_{OUT}} = \frac{1}{8} \cdot \frac{1 - D_{PWM}}{LC \cdot f_{sw(PWM)}^2} \leq 0.01\% \quad \text{Eq 28}$$

And the output capacitor:

$$C \geq \frac{1}{8} \cdot \frac{1 - D_{PWM}}{L \cdot f_{sw(PWM)}^2} \cdot \frac{1}{0.01\%} = \frac{1}{8} \cdot \frac{1 - 0.4}{80 \mu H \cdot (130 kHz)^2} \cdot \frac{1}{0.01\%} = 550 \mu F \quad \text{Eq 29}$$

This value may be able to keep the ripple, but the ESR of the capacitor plays an important role. During load jumps, the major drops and jumps are due to stray inductances and resistive behavior.

Best choice may be a parallel of smaller electrolytic capacitors and a good low ESR cap.

Our board as a general purpose demonstrator is equipped with a single 1000 μF capacitor and a small high frequency ceramic capacitor.

TTF Stage

An additional LC output filter is necessary for EMI/EMC compliance, when the output is connected to a load with cables.

Purpose of this work is to provide a supply for different application, but in particular in conjunction with an on-board motor drive system. For this reason, the LC filter has not been provided.

4.2.3 TTF feedback

The loop feedback is using a standard approach with TL431 and opto-coupler circuit, as shown in.

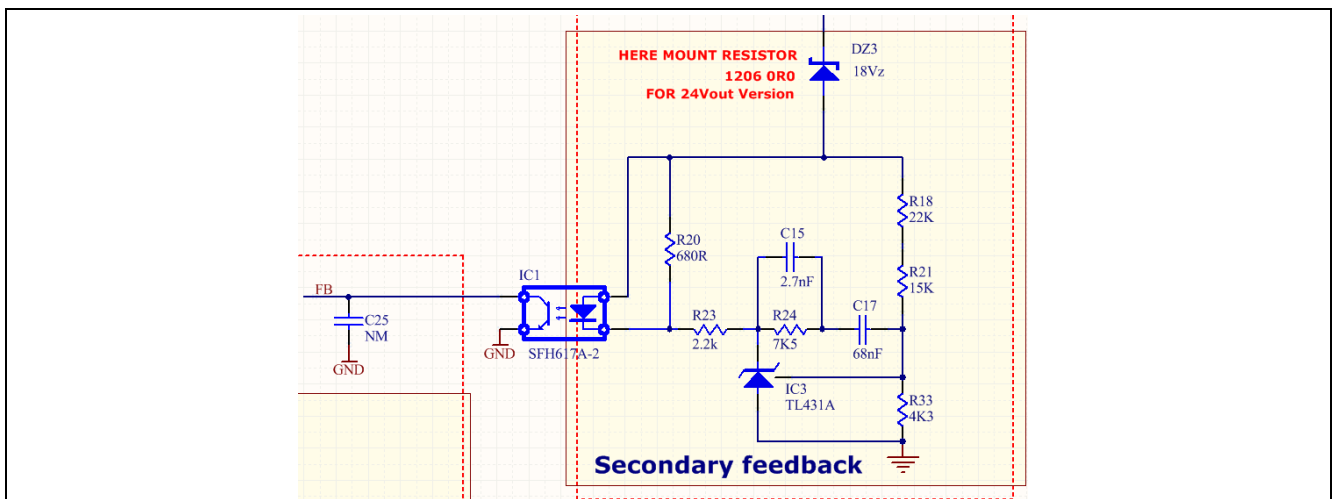

Figure 23 TTF voltage feedback

In particular output voltage can be scaled as follows:

$$V_{out} = 2.5 V \cdot \left[1 + \frac{(R21 + R22)}{R33} \right] + V_{DZ3} = 42 V \quad \text{Eq 30}$$

Note on DZ3:

- TL431A absolute maximum voltage is 37 V and current is 150 mA. DZ3 is used to avoid voltage/current stress on the regulator.
- If different output voltage is desired it can be either chosen a different zener voltage for DZ3 according to Table 8, or DZ3 can be replaced with a 0 Ohm resistor and it can be changed the resistor divider.

Attention:



The power board output stage is designed for 42 V, 300 W peak power.

The board can work for lower output voltages without changing the main components, but:

- Changing the output voltage requires reducing the output current. Approximate output power is indicated in Table 7.
- When keeping the same output power, output diodes, output inductor and transformer **MUST** be redesigned due to higher currents.

300 W general purpose wide-range SMPS PFC + TTF Evaluation Board



TTF Stage

Table 8 Output voltage and power scaling

Desired output voltage	Action	Approximate Max output power (according to 50% duty)	Critical points and optimization
24 V	Replace DZ3 with 00hm resistor	150 W	Output diodes cooling Un-efficient usage of trafo
36 V	DZ3=12 V _z	220 W	Output diodes cooling
42 V	DZ3=18 V _z	300 W	
48 V	DZ3=24 V _z	300 W	

Following the above mentioned table, primary side relaxes to lower power consumption. The main limit is the power dissipation of the output diodes, the current of which is inverse-proportionally increasing as output voltage decrease.

The same transformer can be used for the indicated output voltages, since the controller will act on duty cycle to provide the desired output, BUT it will work with higher output voltages and peak currents than needed. A correct transformer design would generate lower output voltage at rectification diodes, which allows the choice of better rectifiers with lower voltage and current peaks.

A TTF transformer design for 24 V application is also provided by Pulse Electronics (PH9298NL) which specification is shown in Figure 24.

UNLESS OTHERWISE SPECIFIED, TESTING IS PERFORMED AT 25 ±5°C. TURNS RATIO LIMITS ARE SPECIFIED AS MEASURED WITH UNGAPPED CORES.	
PARAMETER	SPECIFICATIONS
OPERATING TEMP	-40°C ~ 125°C
POLARITY	PER SCHEMATIC
TURNS RATIO	(7-5) : (13,14-11,12) = 6.5 ±2% (100%, @AT 100 KHz, 0.1 VRMS)
INDUCTANCE	(5-7) = 3.5 mH ±15% (100%, @ AT 100 KHz, 0.1 VRMS)
LEAKAGE INDUCTANCE	(5-7) WITH 11,12,13,14 SHORTED = 15µH TYPICAL (100%, @ AT 100 KHz, 0.1 VRMS)
DCR	(5-7) = 200mOHMS TYPICAL (SAMPLE)
	(11,12-13,14) = 15.0mOHMS TYPICAL (SAMPLE)
HIPOT	(5,7) TO (11,12,13,14) = 4.0K VAC FOR 1 MINUTE OR 4.5K VAC, FOR 6 S (100%)
	ALL PINS TO CORE = 2.0K VAC FOR 1 MINUTE OR 2.2K VAC, FOR 6 S (100%)

Figure 24 TTF transformer specification 24 V, from Pulse Electronics

5 Auxiliary power supply

A flyback circuit has been implemented in order to provide forward converter start-up and supply. Its input is the bus voltage V_{BUS} , and provides a ground referenced $V_{CC} = 15 V_{DC}$ for the controller board, as well as an insulated $V_{CC} = 15 V_{DC}$ for the high side gate driving for the TTF.

The Auxiliary power supply is designed to provide a max of about 3 W, and the schematic is shown below.

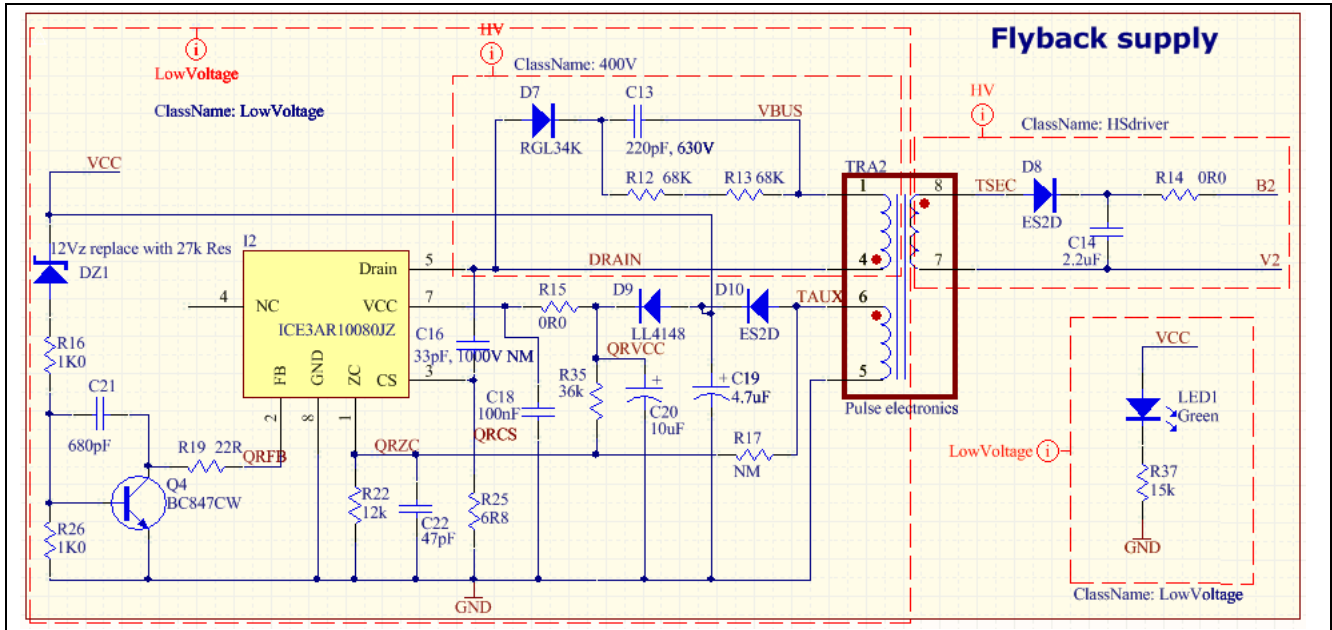

Figure 25 ICE CoolSET™ Auxiliary power supply schematic

The schematic provides the possibility to use both a quasi-resonant flyback as well as a fixed frequency flyback. The choice for this design is the **ICE3AR10080JZ**, which is a 10 Ω , 100 kHz CoolSET™ controller with integrated 800 V MOSFET, in DIP7 package.

The switching frequency of 100 kHz allows the use of a small transformer, with DIP8 footprint. The transformer was designed to be with functional insulation, since it doesn't supply secondary side circuits.

The transformer was provided by **Pulse Electronics (PH9323NL)** with the attached specifications:

UNLESS OTHERWISE SPECIFIED, TESTING IS PERFORMED AT 25 \pm 5°C.
TURNS RATIO LIMITS ARE SPECIFIED AS MEASURED WITH UNGAPPED CORES.

PARAMETER	SPECIFICATIONS
OPERATING TEMP	-40°C ~ +85°C
POLARITY	PER SCHEMATIC
URNS RATIO	(4-1) : (6-5) = 6.172 \pm 2% (AT 100 KHz, 0.1 VRMS) (4-1) : (8-7) = 6.172 \pm 2% (AT 100 KHz, 0.1 VRMS)
INDUCTANCE	(1-4) = 5.0 mH \pm 25% (AT 100 KHz, 0.1 VRMS)
LEAKAGE INDUCTANCE	(1-4) = 26.0 uH TYPICAL (AT 100 KHz, 0.1 VRMS, 8,7,6,5 SHORTED)
DCR	(1-4) = 4.4 OHMS TYPICAL
	(5-6) = 0.95 OHMS TYPICAL
	(7-8) = 0.93 OHMS TYPICAL
HIPOT	(1,4) TO (5,6,7,8) = 2.3 KVAC, 60 S OR 2.5 KVAC, 6 S
	(5,6) TO (7,8) = 0.5 KVAC, 6 S
	ALL PINS TO CORE = 0.5 KVAC, 6 S

Figure 26 Flyback transformer specification, from Pulse Electronics

300 W general purpose wide-range SMPS PFC + TTF Evaluation Board



Auxiliary power supply

Design guidelines for the flyback design can be found in Infineon website, at CoolSET™ fixed frequency controller page, searching for ICE3AR10080JZ.

The auxiliary supply is taken from the bus voltage and start-up is guaranteed from 80 V_{AC} input. As soon as the PFC starts working, the Bus voltage goes to 380 V. The auxiliary power supply works mainly in burst mode, which allows low power consumption and less emission.

The advantage of a flyback supply is the possibility to add windings and provide insulated supply voltage to the secondary side. This requires a different insulation for the transformer, but helps especially when a complete turn-off of the main power stage (PFC+TTF) is required by the secondary side controller, while the auxiliary works as a low consumption standby supply.

This Application Note does not implement the above mentioned proposal, which is anyway recommended to achieve very low standby consumption and full control of the power stage from the secondary side.

The auxiliary flyback can be configured in a quasi-resonant configuration allowing to use the ICE2QR4765Z. The list below shows the modifications on the power board, which are necessary to use one or the other solution.

Note: While the Fixed Frequency configuration has been tested and optimized, the Quasi-Resonant configuration is provided by theory and has not been tested.

Table 9 Fixed Frequency vs Quasi-Resonant Flyback component configuration

Component	Fixed frequency flyback	Quasi resonant flyback
Device	ICE3AR10080JZ	ICE2QR4780Z
R35	Mount	Do Not Mount
R17	Do Not Mount	Mount
C16	Do Not Mount	Mount
R22	Mount	Mount

Control card with ICE1CS02G

6 Control card with ICE1CS02G

The control card schematic is shown in Figure 5. The design of the pin-out is such that it would be easy to use another controller to manage the power board.

Control card is equipped with ICE1CS02G combi (PFC+Forward) controller which features can be found in the product datasheet available at www.infineon.com.

The control card is shown in Figure 27 and can come soldered to the power-board.

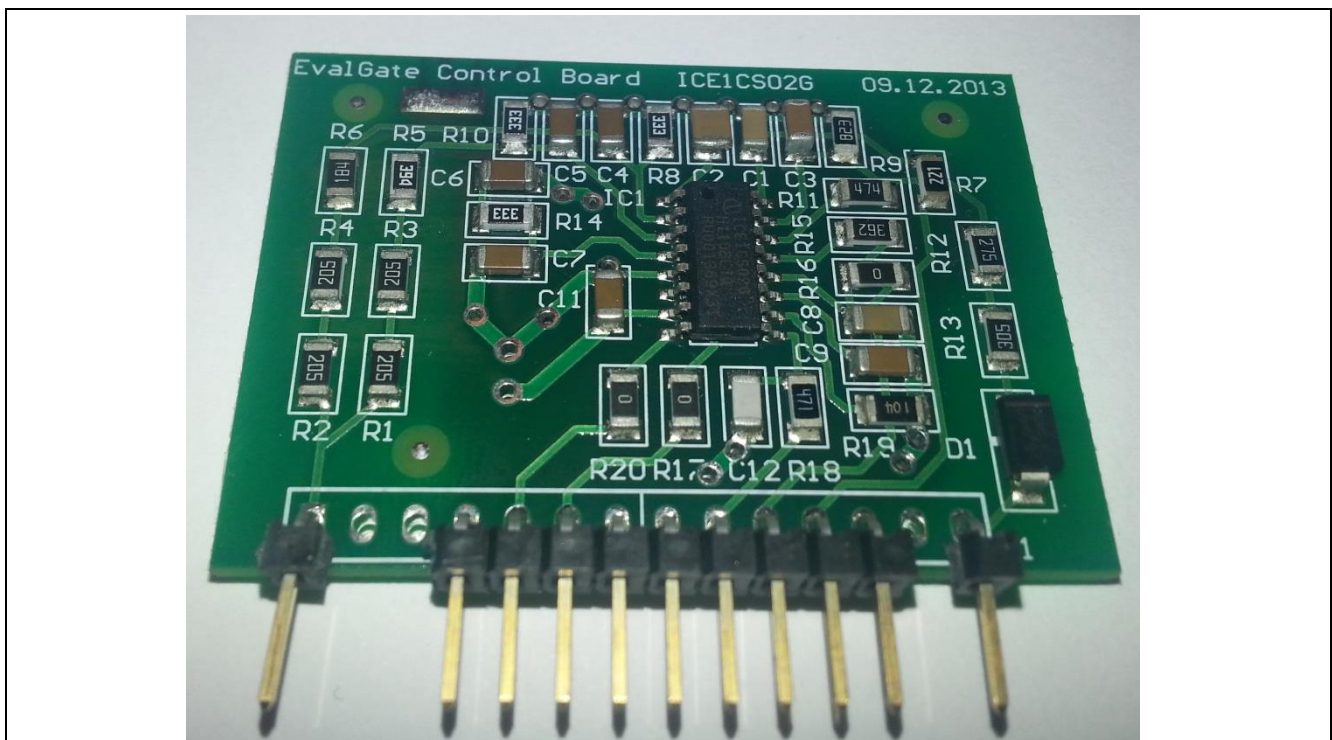

Figure 27 Control card

Connector is described in the following table:

Table 10 Control card connector

1	2	3	4	5	6	7	8	9	10	11	12	13	14
VBUS			VCC	PWMout	PFCout	VCC	GND	PWMcs	FB	PFCcs	GND		RECac+

Pin 1 and Pin 14 are connected to high voltage, please be careful when handling the control cards while connected to the power board.

A alternative daughter-board using PFC CCM controller ICE3PCS01G + separate TTF controller is also available. Please ask Infineon representative, in case of need.

In the following chapter it is describer how to size the main control inputs to manage the power board.

6.1 PFC voltage and current loop

Pin 14: RECac+

Pins VINS (Input Voltage Sensing) and VINS HYS (Input Voltage Sensing Hysteresis) of the combi combi controller derive from RECac+ thorough a resistor divider. These controller pins sense, in fact, the rectified AC main line signal RECAC+.

VINS senses the input mains voltage protecting the system from brown-out (BOP): brown-out happens when the input voltage $V_{IN_{RMS}}$ falls below the minimum designed input voltage (i.e. $V_{IN_{RMS}} < 85.0 V_{AC}$). Brown-out protection avoids large currents flowing in the PFC stage in low-line voltage conditions. When input voltage is under minimum designed input voltage, i.e. $V_{IN_{RMS}} < 85.0 V$, PFC gate signal is stopped and then resumed with standard start-up procedure when proper AC input voltage is restored.

Maximum value of RECAC+ ($\sim \sqrt{2} \cdot V_{IN_{RMS}}$) is hence detected by this pin and maintained by a capacitor: when proper input voltage is applied ($85 V_{AC} \leq V_{IN_{RMS}} \leq 265 V_{AC}$), stand-by mode is switched-off. Hysteresis pin (VIN HYS) prevents the system to oscillate between normal and stand-by mode.

Pin 1: VBUS and Pin 6: PFC out

Here are connected the pins of PFC VSENSE (Bus Voltage Sense / Feedback) and PFC OVP (Overvoltage Sense Input). Output bus voltage VBUS is sensed via a resistive divider. PFC OUT is then enabled and PFC duty cycle DPFC is gradually increased by soft-start until VBUS reaches the desired voltage, thus also enabling the PWM TTF controller section.

On the other hand, PFC OVP provides overvoltage protection by reducing or stopping the PFC duty cycle.

Pin 11: PFC CS

Associated to PFC CS is the controller pin PFC ISENSE (Current Sense Input). This input senses the PFC MOSFET current by resistance RSHUNT_PFC. RSHUNT_PFC has been designed on the ICE1CS02 PFC peak current limitation (PCL, VPCL) protection: when the PFC ISENSE signal reaches the PCL threshold, PFC gate switching will shut down.

Leading Edge Blanking time (220 ns, LEB) is integrated in order to prevent current limit protection from distortions caused by edge spikes; moreover; an additional filtering can be set by adding a capacitor between PFC ISENSE and ground. According to IC datasheet, PCL threshold for PFC stage is about $-0.60 V$. Check for shunt resistor sizing in chapter 3.3 (“PFC Shunt resistor”) on page 15.

Pin 10: FB and Pin 5: PWM OUT

Pin FB is the TTF stage voltage feedback, associated with Pin 12 – PWM FB (PWM Feedback): output voltage VOUT is sensed by PWM FB via opto- opto-coupler. PWM OUT (controller pin 8) regulates duty cycle of the TTF converter in order to achieve a regulated output voltage VOUT. Feedback loop and controller are electrically isolated: error voltage signal is provided to the controller by a 1:1 current from opto-coupler and compared to the internal reference voltage ($V_{REF}=5 V$). PWM OUT is provided to Q2 and Q3 by a gate driver IC 2EDL05I06BF which is described in chapter 4 (“TTF gate driver 2EDL05I06BF”) on page 6.

Pin 9: PWM CS:

PWM CS provides the TTF current sense information to the controller IC PWM CS pin (PWM Current Sense). RSHUNT_PWM value has been designed to provide peak current limitation (V_{csth}) via ICE1CS02 PWM protection. According to IC datasheet, PWM threshold for PFC stage $V_{csth} = 1.00 V$. Shunt sizing is explained in chapter 4.1.3 (“TTF shunt resistor”) on page 21.

300 W general purpose wide-range SMPS PFC + TTF Evaluation Board



Control card with ICE1CS02G

In case noise filtering is necessary, it can be set by adding a RC-network (R18 and C12); in this board,
 $\tau = R18 \cdot C12 \sim 300 \text{ ns}$.

When the PWM ISENSE signal at pin 9 reaches the limit threshold for a period set externally through pin 11 (PWM Pre-Short), the TTF control is switched off. Timing of Preshort is set to about $\sim 10 \text{ ms}$ with $C9 = 100 \text{ nF}$. There is no restart of the system, unless the input line is cycled. Please refer to ICE1CS02G datasheet for details.

7 Converter test results

Power supply test results will be briefly shown in this chapter. Tests were performed at ambient temperature with various loads. Collection of data is done on a single prototype (no statistical data was performed).

7.1 Converter efficiency

Converter efficiency is measured at ambient temperature with the parts proposed in this application note and it is published here below for 220 V_{AC} input as well as 110 V_{AC} input.

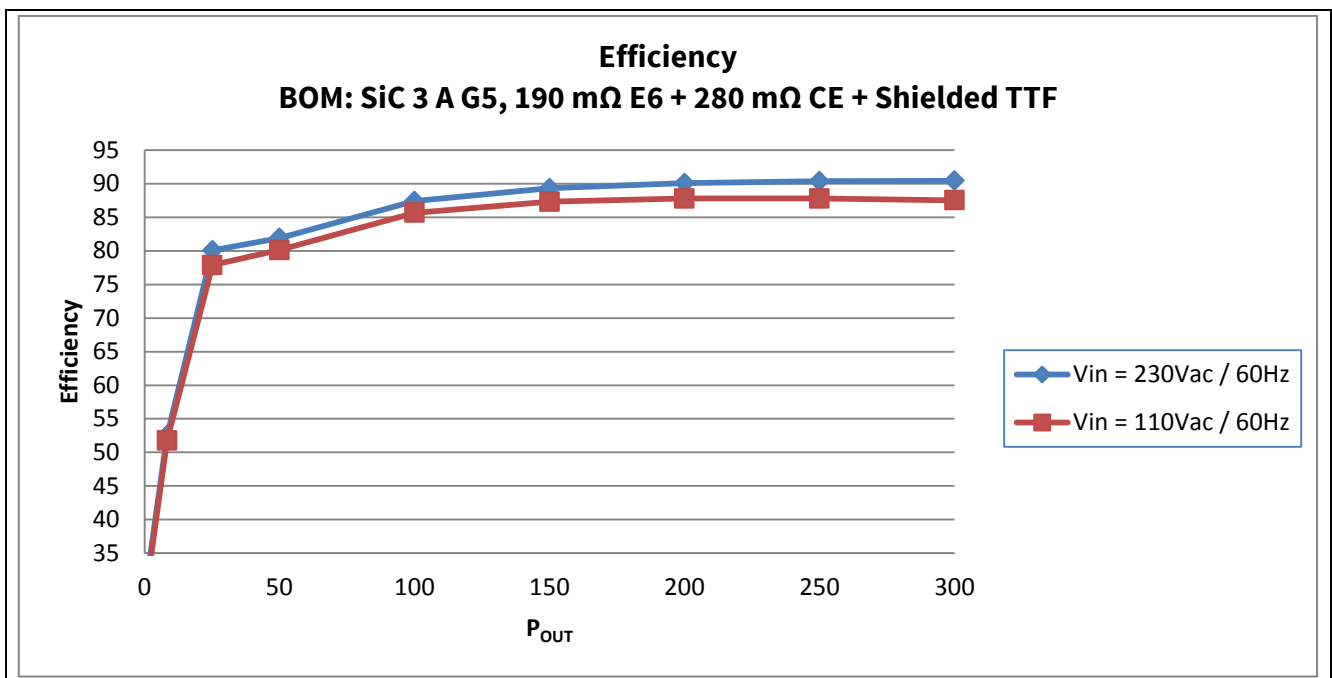

Figure 28 Efficiency chart at 42 V output

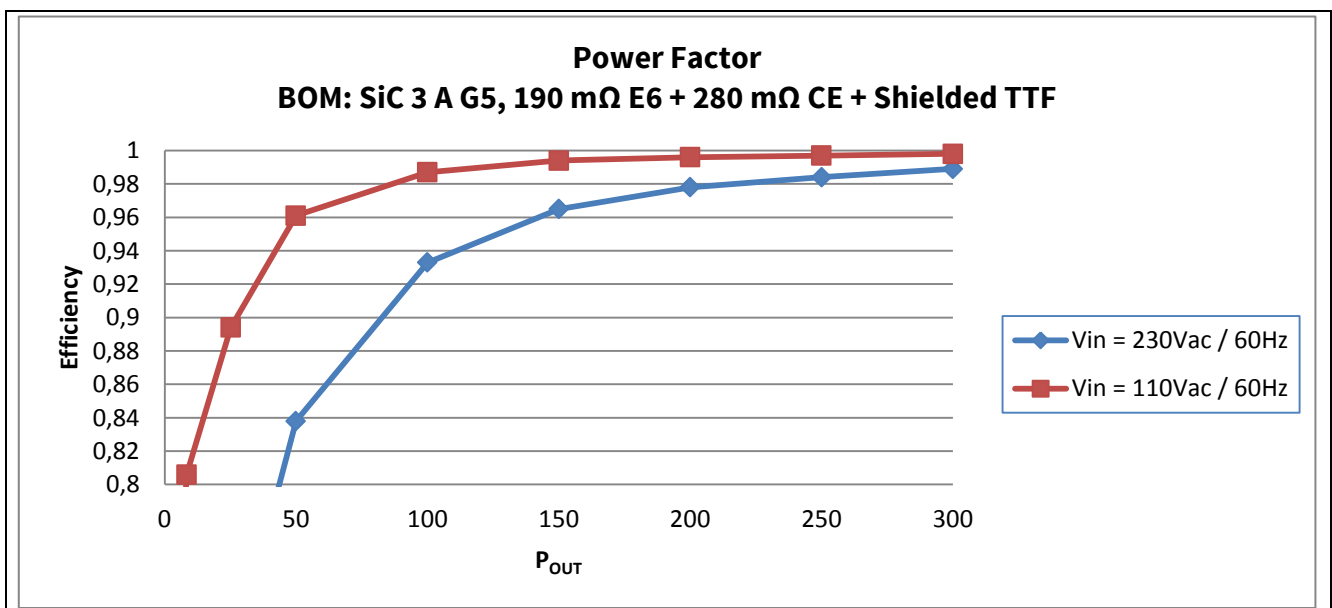

Figure 29 Power Factor chart at 42 V output

Converter test results

7.2 Converter waveforms

7.2.1 PFC plots

PFC inductor plays a great role in the PFC design. Since this is not an Application Note for magnetics, we are not going to spend much time on the inductor design, but some important things must be noticed.

The following PFC waveforms are taken with different winding styles, bringing to quite different results.

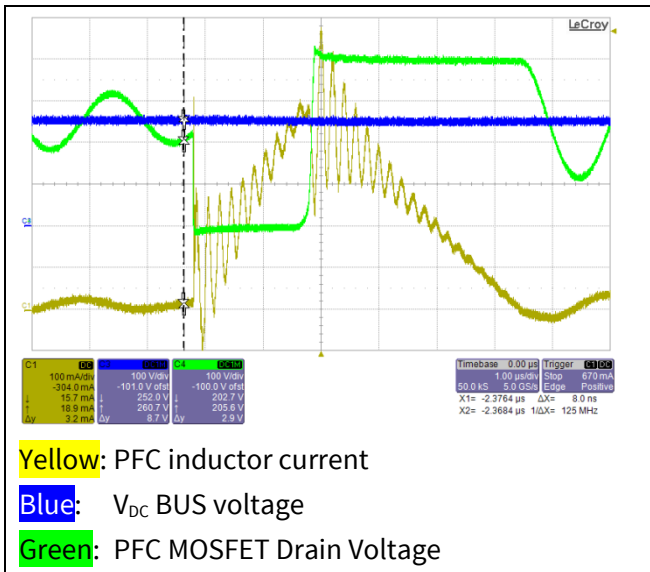

Figure 30 Original design

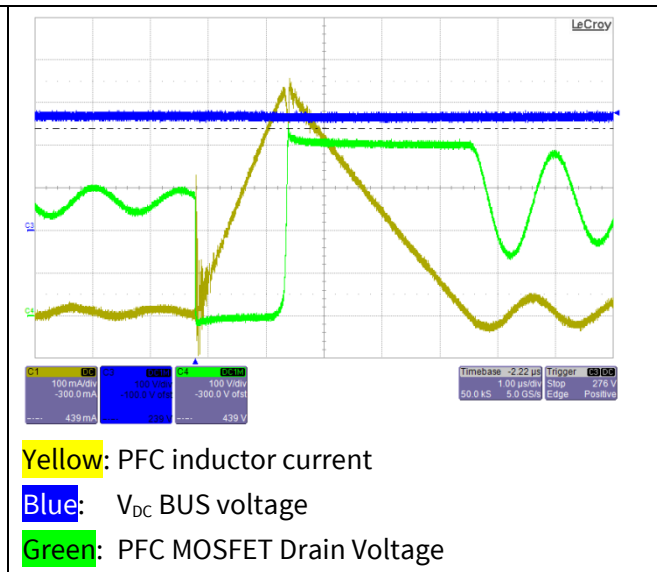

Figure 31 Re-wound manually in 4 sectors

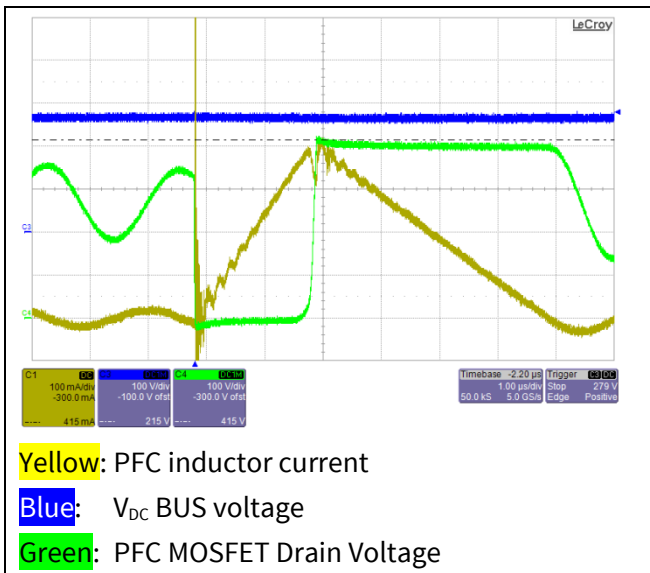

Figure 32 Re-wound from manufacturer in 4 sectors (final)

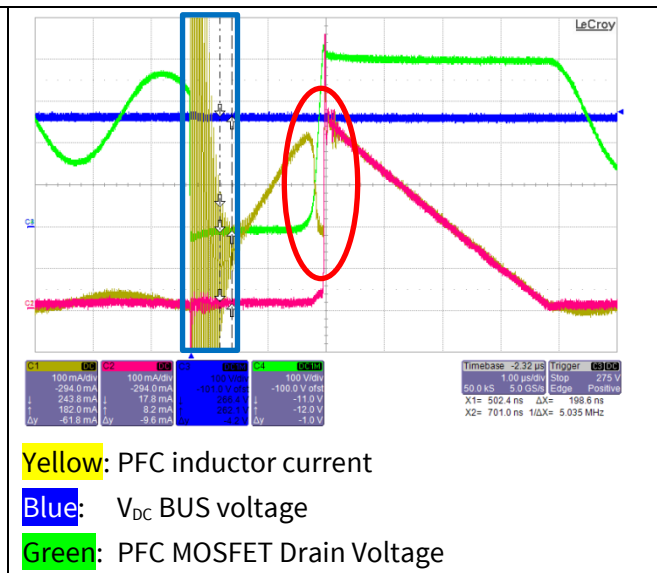

Figure 33 Other manufacturer design

Converter test results

Waveform explanation follows:

Figure 30: Original design

Strong inter-winding coupling generate oscillations in the 10 MHz range (superimposed to yellow trace), clearly visible in EMC test. Beginning and end of winding are superimposed in large part of the toroidal core.

Figure 31: Re-winded manually in 4 sectors

Manual winding didn't allow same number of turns to test the absence of inter-winding coupling. Much less coupling reduces drastically oscillations, which eventually shifted to very high frequency and lower amplitude. Space is left intentionally between beginning and end of winding to reduce the capacitive coupling between the physical leads.

Figure 32: Re-winded from manufacturer in 4 sectors (final)

Automatic winding with required inductance value in 4 sectors reduced greatly the inter-winding coupling, with a visible effect of oscillation reduction. Still some high frequency oscillations are present.

Figure 33: Other manufacturer design

Another manufacturer design has been tested, which is shown here to provide different scenarios. Capacitive coupling between beginning and end of winding is clearly visible at current peak in the big dip circled in red.

Very high frequency oscillations at MOSFET turn-on are produced instead by the cross-winding coupling, which in this design is extended along the toroidal shape (blue square).

(Purple trace is PFC diode current, superimposed to inductor current)

Following plots are taken at 85 V_{AC} input. Please note that the horizontal scales may change!

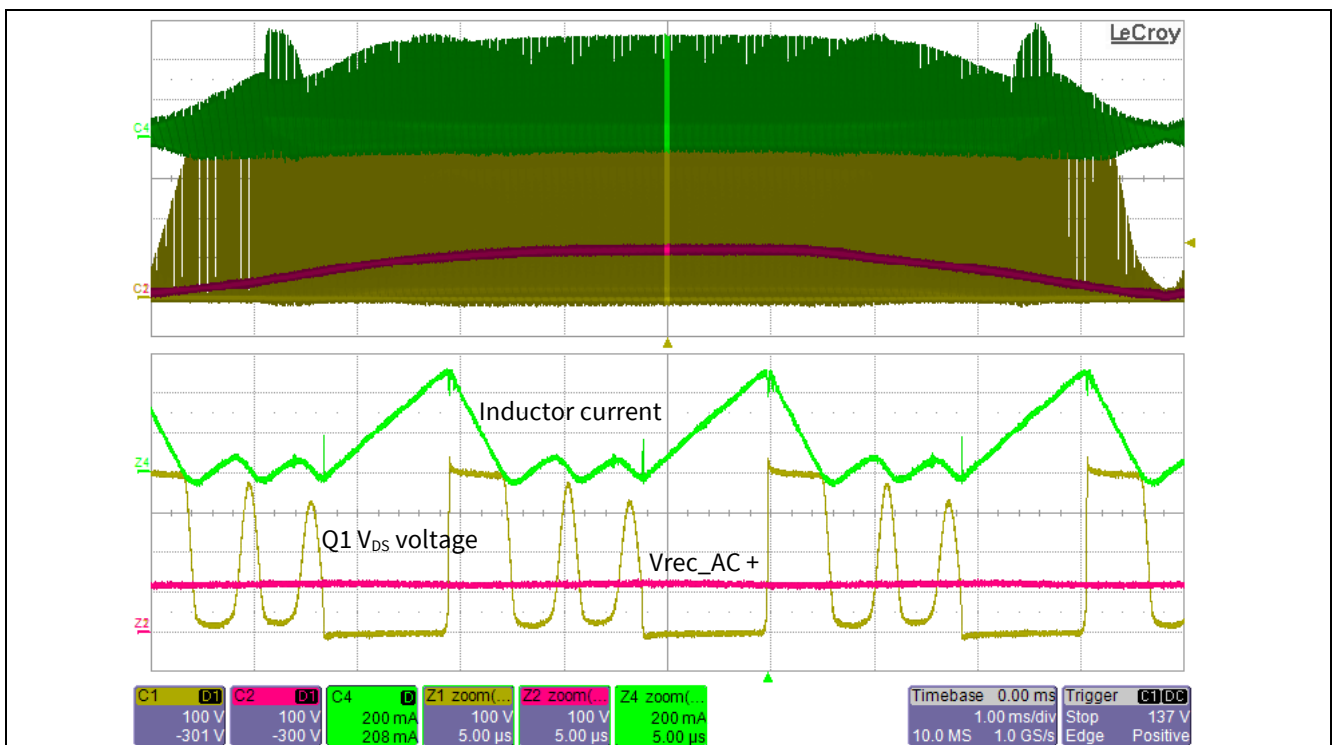

Figure 34 PFC 85 V_{AC}, 5 W_{out}

300 W general purpose wide-range SMPS PFC + TTF Evaluation Board



Converter test results

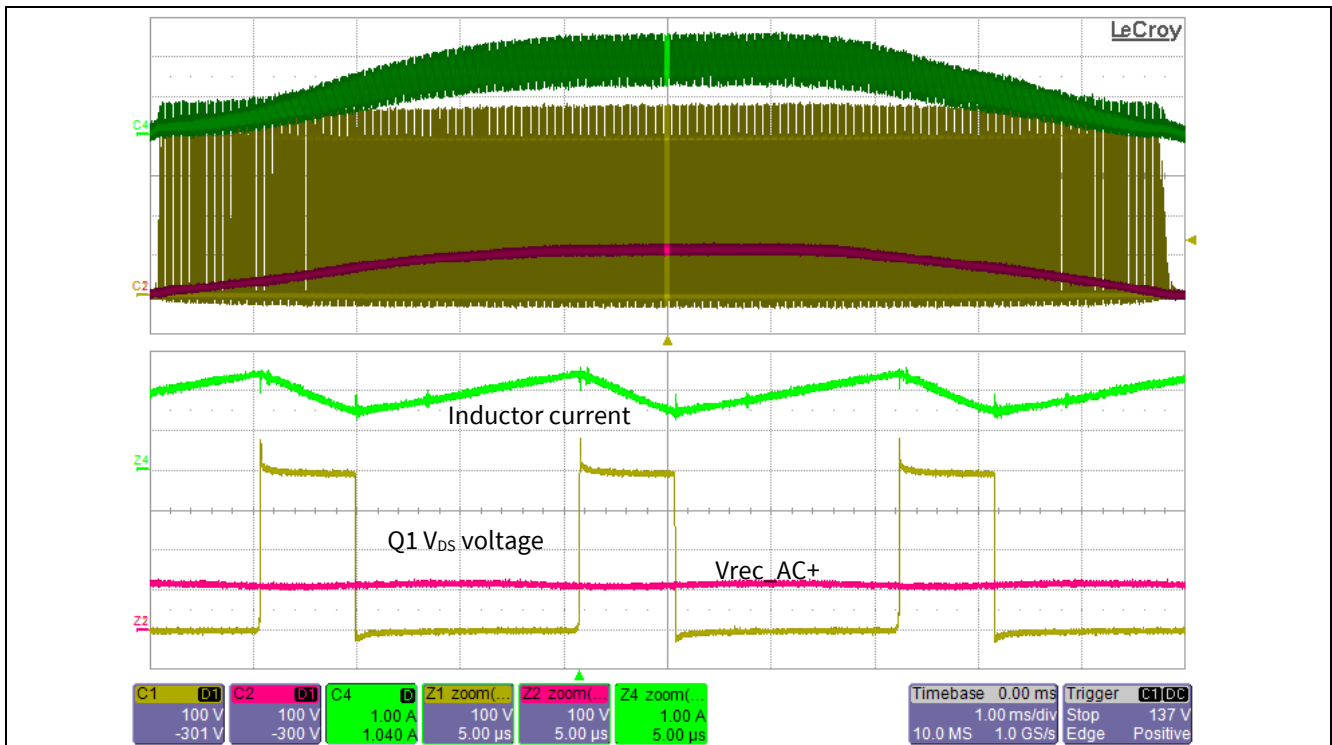

Figure 35 PFC 85 V_{AC}, 100 W_{out}

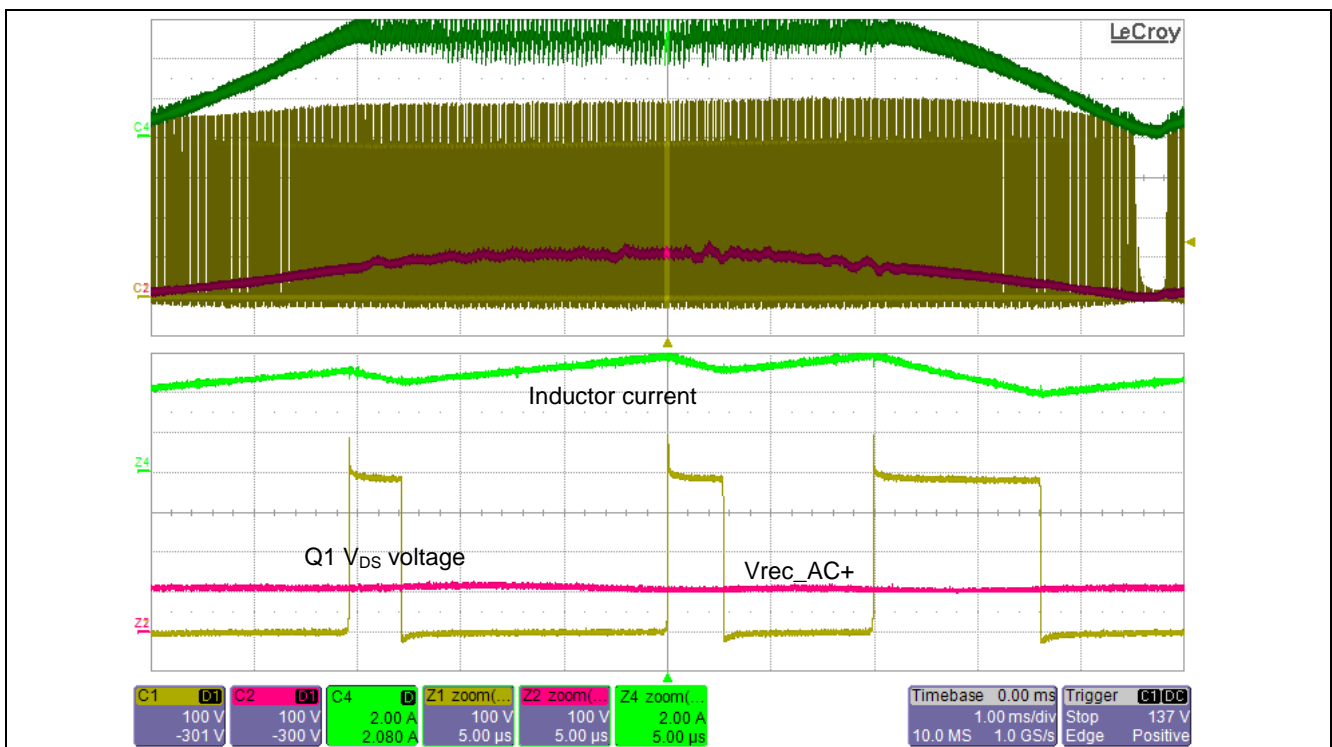

Figure 36 PFC 85 V_{AC}, 300 W_{out}, PFC current limiting

At 300 W output with 85 V_{AC} input, PFC stage is at current limit. Cycle-by-cycle limitation get triggered. Peak voltage at MOSFET drain is less than 500 V.

300 W general purpose wide-range SMPS PFC + TTF Evaluation Board



Converter test results

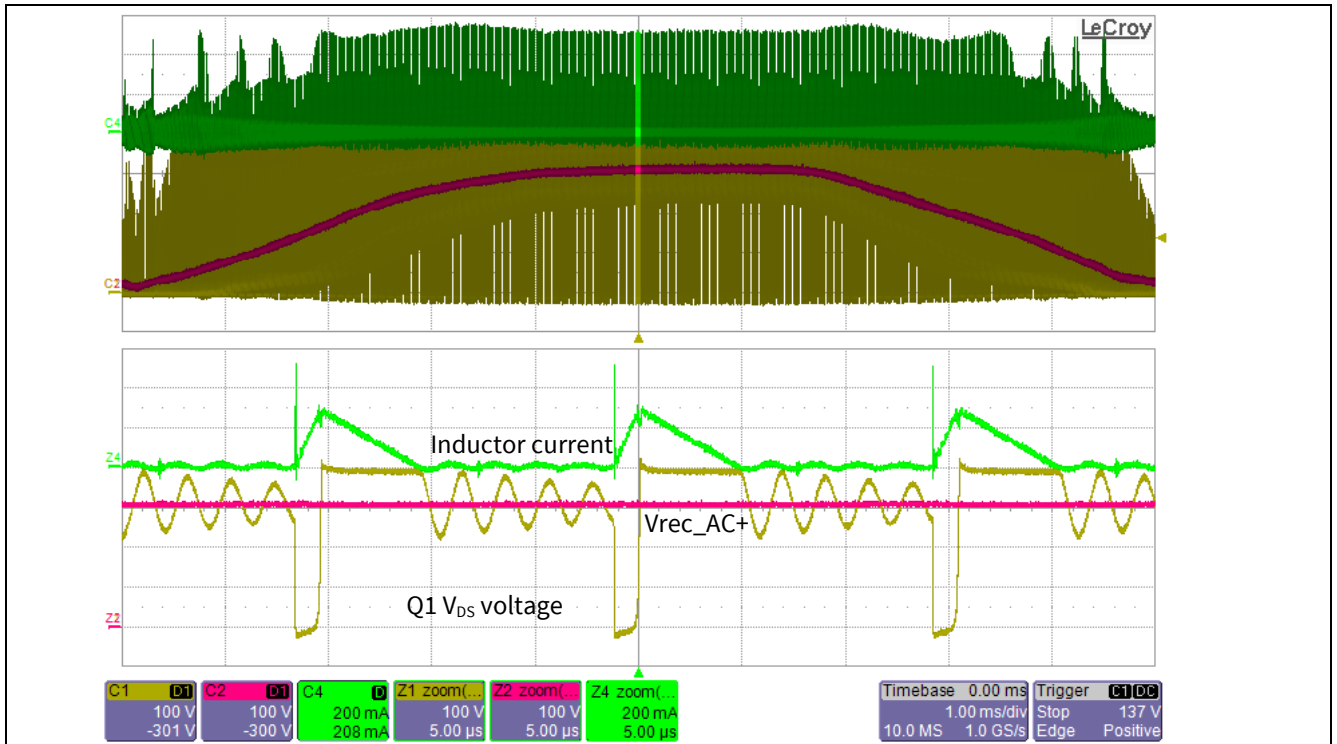

Figure 37 PFC 220 V_{AC}, 5 W_{out}

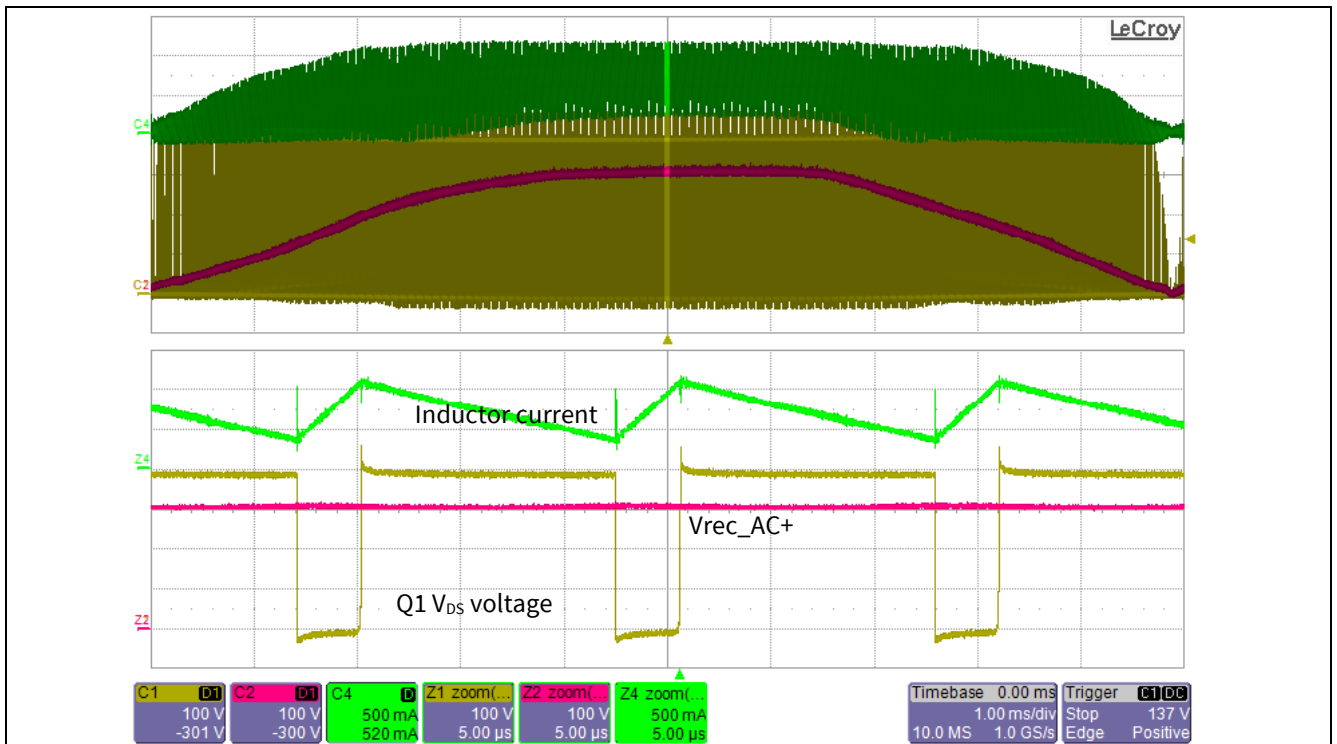

Figure 38 PFC 220 V_{AC}, 100 W_{out}

Converter test results

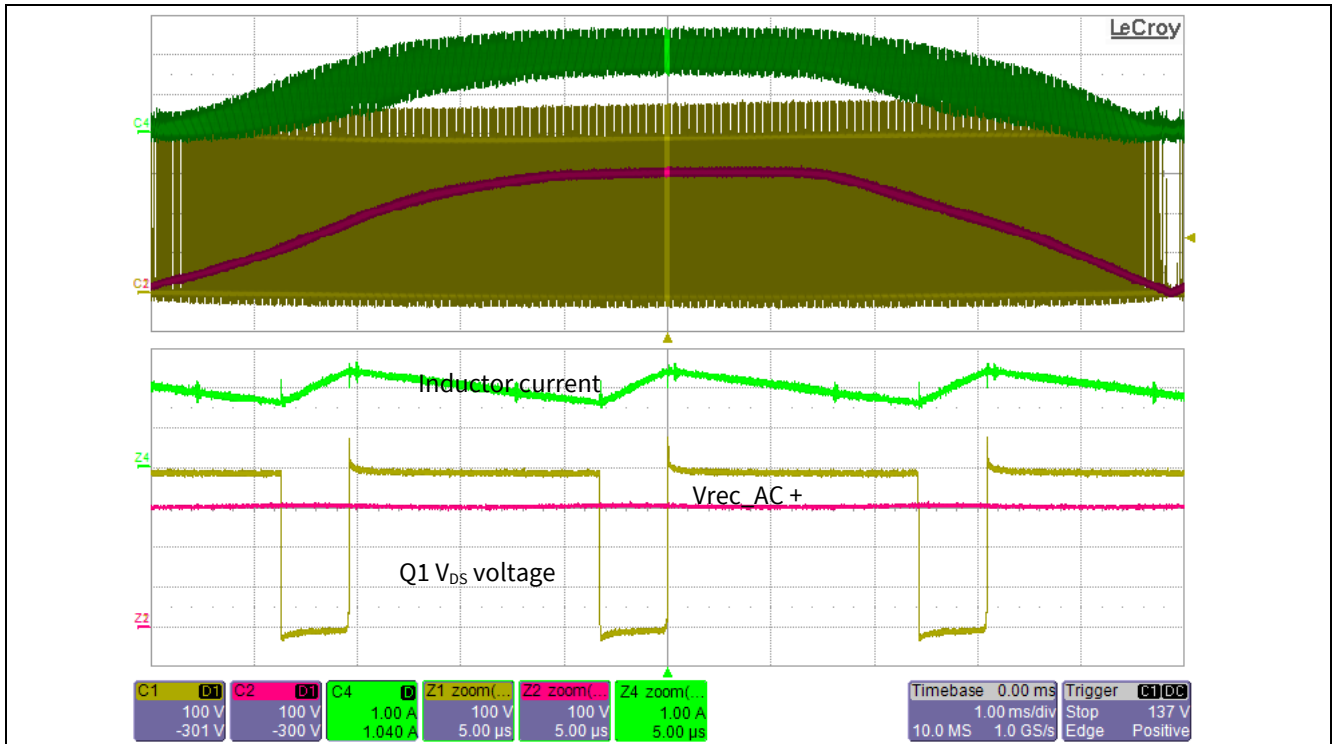

Figure 39 PFC 220 V_{AC}, 300 W_{out}

7.2.2 TTF plots on primary side

Primary side plots are shown below. Gate driver signal for TTF is also plotted in green.

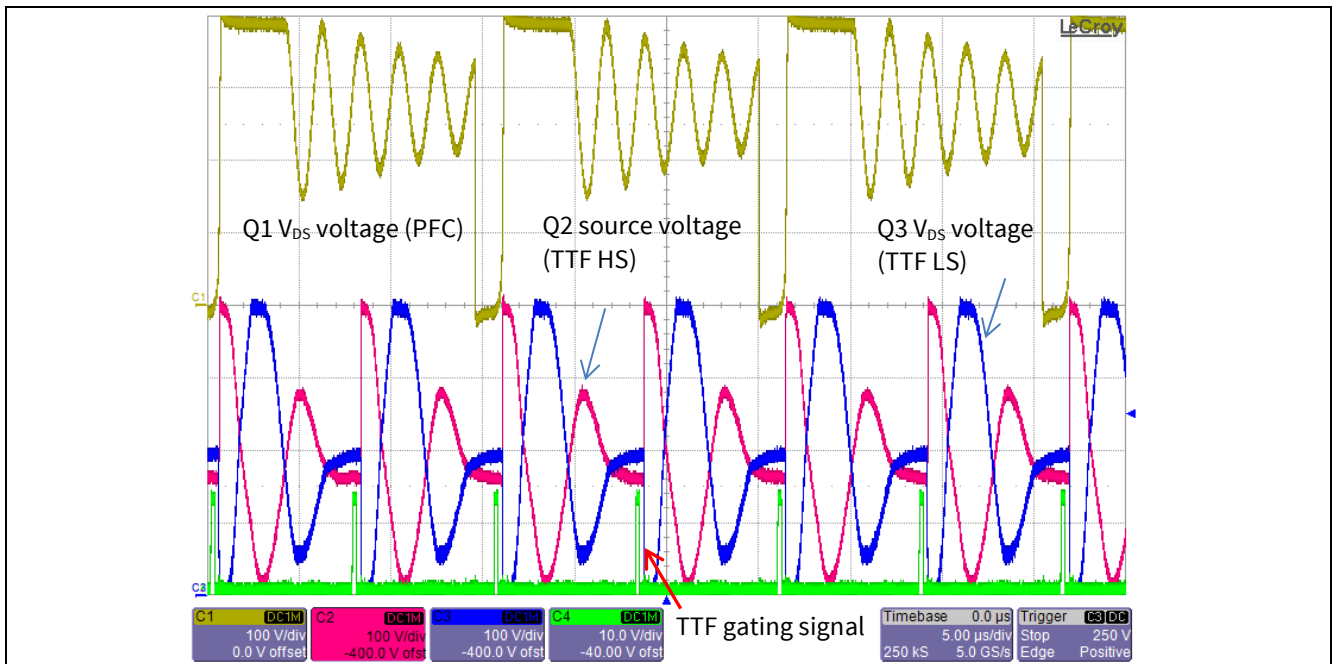

Figure 40 TTF 5 W output load

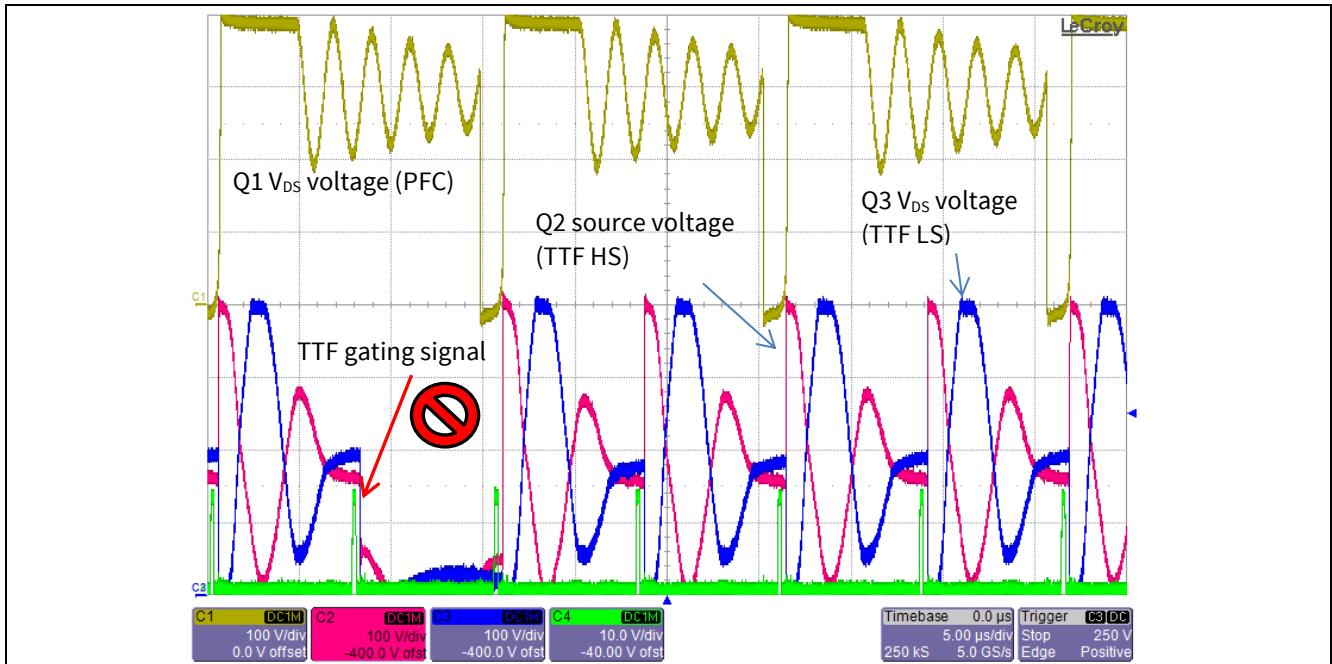

Figure 41 TTF 5 W output load, pulse skip

Figure 40 shows that PFC drain pulses (in yellow) are synchronized at half TTF pulses as expected. In Figure 41 effect of pulse skipping is visible in light load conditions. Pulse skipping is not a due to the control algorithm: it is implemented by the gate driver IC to avoid short pulses on MOSFET gates. The minimum input pulse-width of the **2EDL05106BF** gate driver IC is specified in the datasheet as follows in $t_{FILIN}=192$ ns typ. parameter. A shorter pulse causes a skipped commutation of the outputs. It is to be noticed that a very small change in the input pulse-width while close to the t_{FILIN} time may create either the high-side or the low-side to skip the pulse. In the example shown in Figure 41, the high-side pulse is skipped. From the control point of view, at low loads the system will be kept by the feedback loop around the t_{FILIN} point, with some more ripple at the output, but a safe operation of the MOSFETs.

7.2.3 TTF plots on secondary side

On TTF output side measurement is done with respect to output ground line. Output is shown in load-step condition under the following transitions:

Table 11 Load step test

Time [s] - load step duration	Output load current [A]	Output power [W]
0.1	0.1	4
4	7.3	300
1	3	130
4	7.3	300
0.2	0.1	4

300 W general purpose wide-range SMPS PFC + TTF Evaluation Board



Converter test results

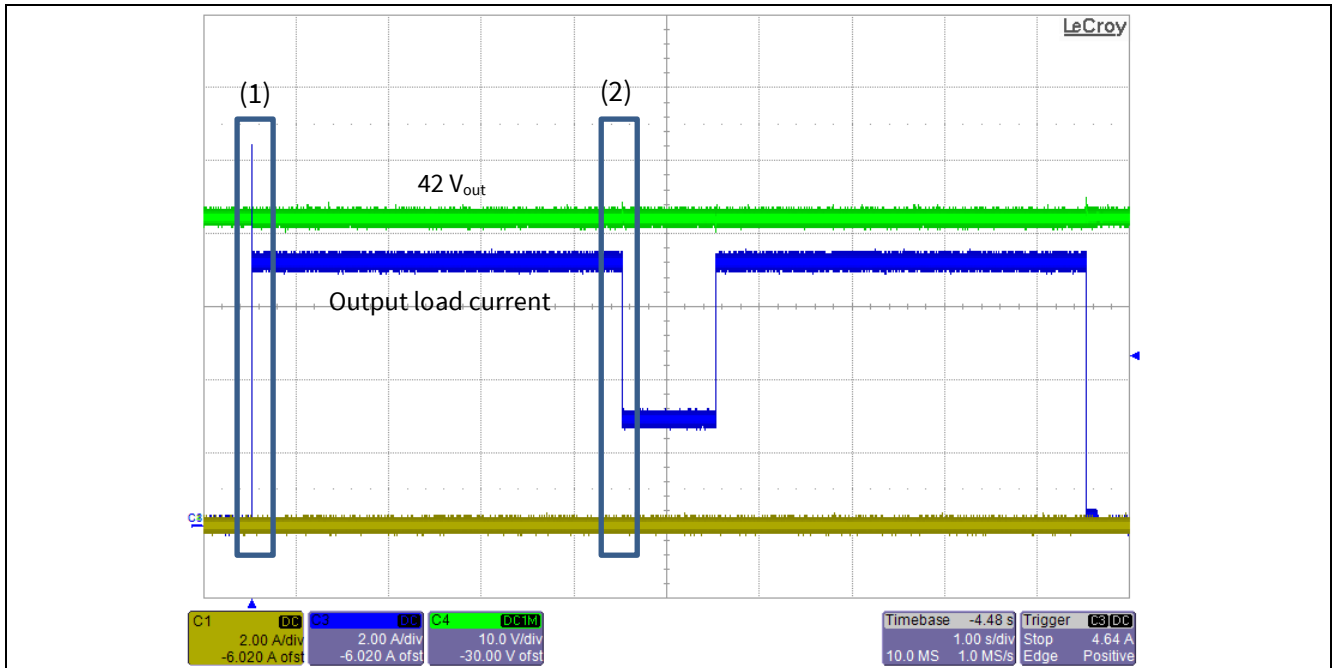

Figure 42 Load step test, overview

Numbered squares (1,2) are detailed in the Figures 43 and 44.

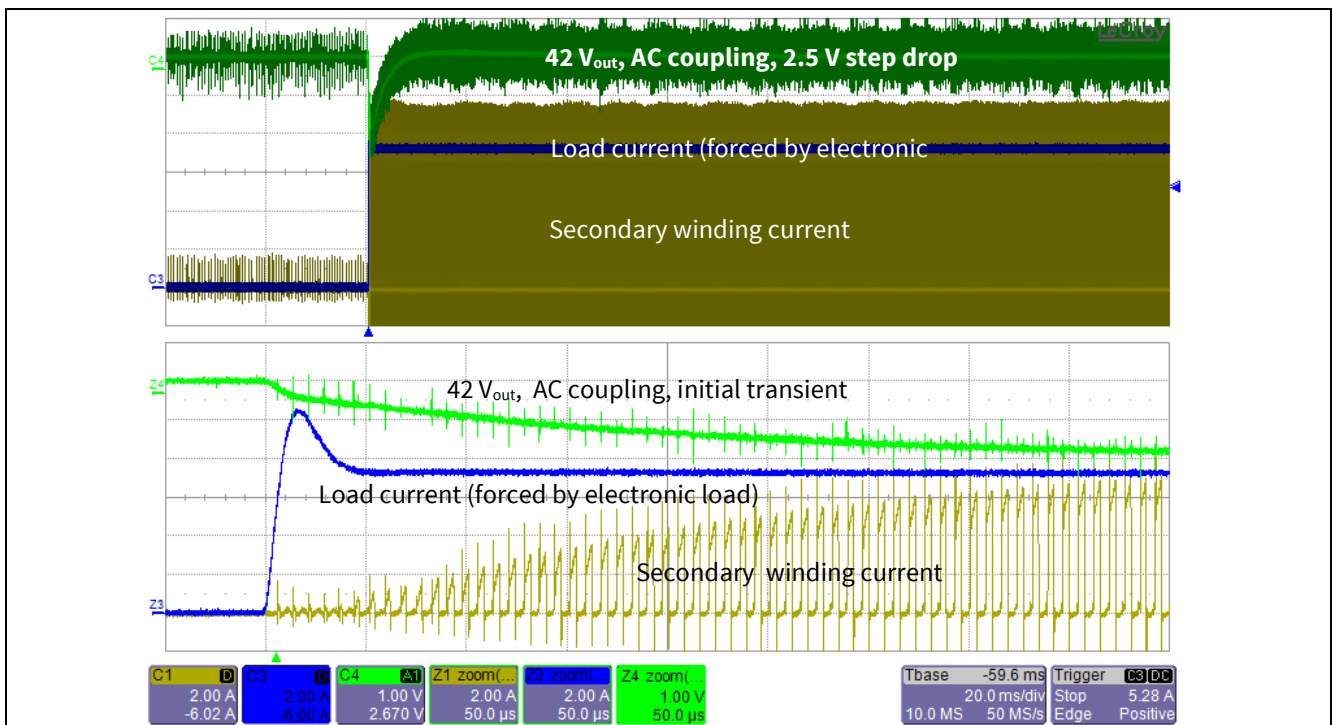

Figure 43 Step response detail, 4 W to 300 W (1)

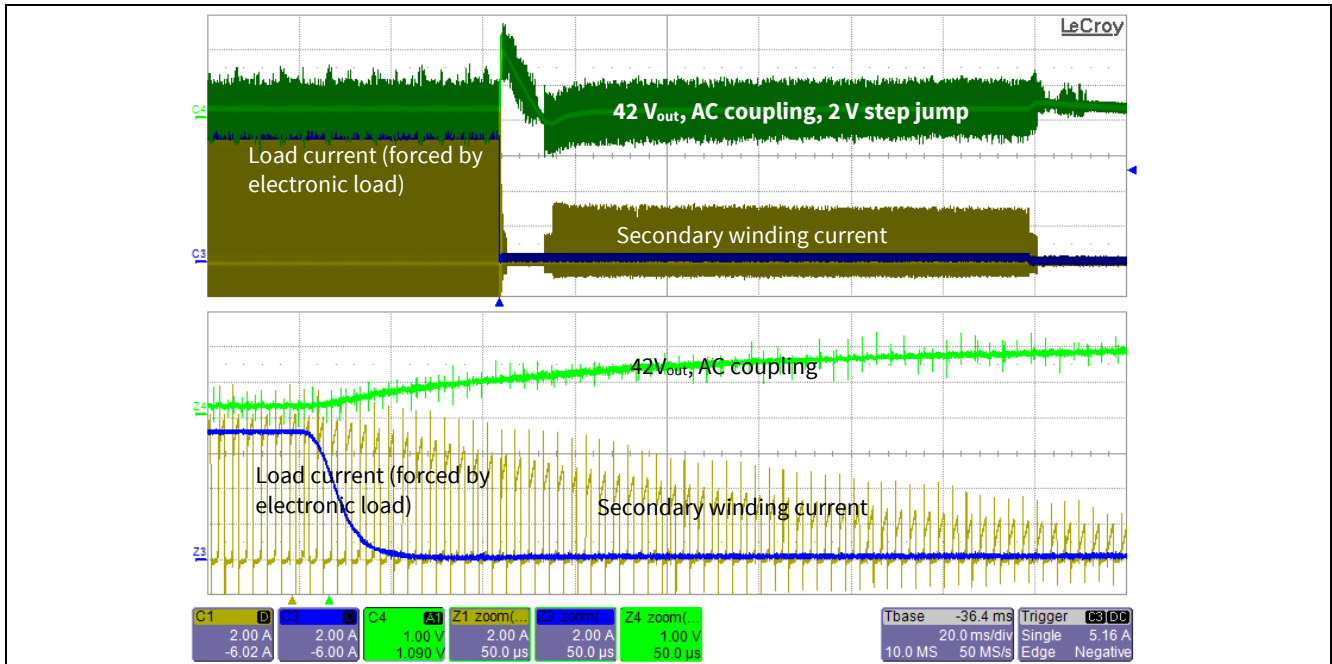

Figure 44 Step response detail, 300 W to 4 W (2)

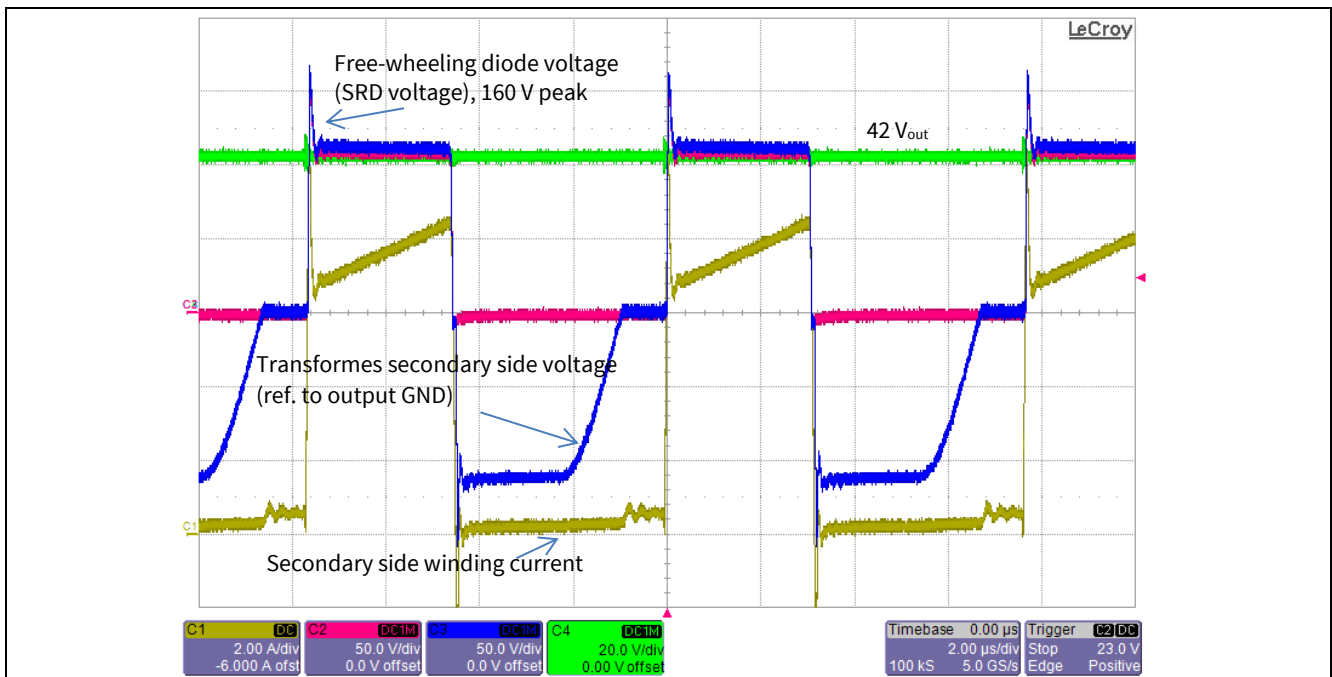

Figure 45 300 W load, output waveforms

7.2.4 Flyback supply

Flyback circuit generates the 15 V_{DC} voltage to supply the control board and the low side driver IC supply as well as the floating 15 V_{DC} supply for the high side TTF MOSFET.

The flyback supply works in active burst mode in order to reduce power consumption to minimum, while the consequent 15 V_{DC} ripple is well ignored by the control stage.

300 W general purpose wide-range SMPS PFC + TTF Evaluation Board



Converter test results

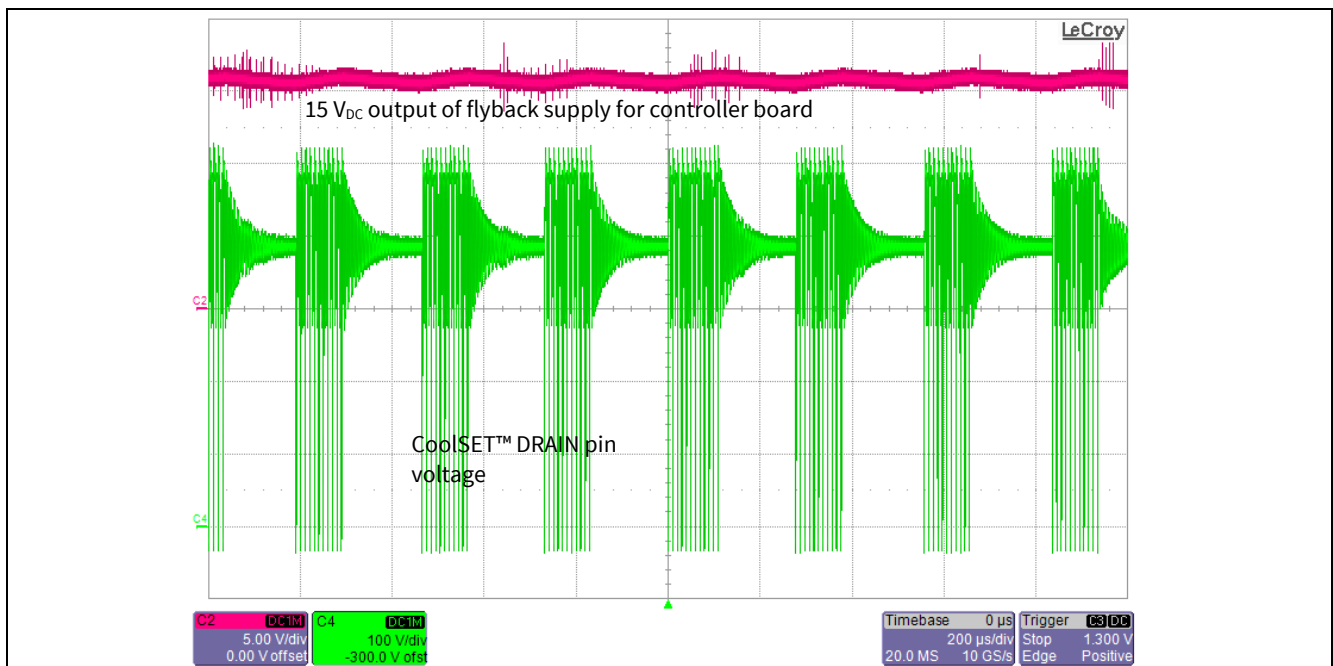

Figure 46 Flyback supply waveforms

Burst frequency changes from output no-load condition to load condition, due to continuous PWM activity at PFC and TTF stages in the second case.

Flyback waveform is taken as an example in Figure 46. There is margin to load the flyback supply up to some Watt power.

The flyback supply is designed to start at 85 V_{AC} input, and it is connected to 400 V_{DC} bus.

8 Final considerations

The presented demonstrator is designed to provide a regulated output voltage under step-load change conditions, such as supplying motor drive stages or switching un-constant loads. It has been therefore indicated as “general purpose” design.

The Combi Control IC card, equipped with ICE1CS02G, can be replaced with different control cards in order to evaluate different strategies. Some possible alternatives include XMC ARM microcontroller family from Infineon, which may allow maximum flexibility of the control algorithm.

Points of improvement for the demonstrator are listed:

- Provide better cooling for the output diodes, especially for continuous output load
- Output filter and EMI tests are not provided: the demonstrator is not designed to be a stand-alone power supply, but to be included in a wider system. In case of stand-alone usage, the output filter must be included to reduce Conducted EMI.
- The TTF transformer is not shielded. Better EMI figures can be obtained with a copper-band shield in between primary and secondary side.
- In a board layout redesign, it is suggested to reduce TTF freewheeling paths to reduce thermal dissipation and current loop.
- The input GND_EARTH shield can be effective if connected to a metallic enclosure surrounding the demonstrator, alternatively keep GND_EAERTH disconnected. The demonstrator may come not equipped with Y caps.
- A harder connection of the PFC and TTF heatsink H1 to GND (VBUS C4-minus) should be done in case of a layout redesign in order to provide better natural shielding to the commutation noise of the input stages.

In order to improve standby consumption, there can be some alternatives like:

- Shut-off the PFC-TTF stages completely (it is needed a redesign of the control board) and keep only the aux-flyback supply active.
- Alternatively, in case a secondary side controller is used, provide an insulated signal to shut-off the PFC-TTF stages from the secondary side controller. It is needed a redesign the aux-flyback transformer to provide an insulated supply to the secondary side, which keeps the standby power for the secondary side controller.

9 Bill of Material (BOM)

Table 12 Bill of Material

Designator	Mount	Footprint	Description	Comment	Manufacturer
BR1	No	D_BRIDGE - slim	BRIDGE RECTIFIER GBU8J 8A 600V	GBU8J	Vishay
C1	No	C_MKT7X18X12.5	MKP cap 100 nF 630 V DC 250 V _{AC}	100 nF 630 V	Epcos
C2, C3	No	C_MKT8.5X26X15	MKP cap 0.47 uF	0.47 µF	Epcos
C4	No	C_POL30_SNAP10	Aluminum Electrolyte 220 uF 450 V 3000 h 105°	220 µF 450 V	Panasonic
C5, C9	Yes	C_E1 size - Panasonic	1 nF 250 V, 1 nF 250 V	1 nF	Panasonic
C6	No	C_MKT7X18X12.5	MKP cap 100 nF 450 V _{DC}	100 nF 450 V	Epcos
C7	No	C_POL_D10/12.5	Elco, 1000 µF, 63 V	1000 µF, 63 V	Nichion
C8	Yes	1206C	MLCC 4.7 µF X7R 1206 >=63 V	4.7 µF, 63 V	AVX
C10, C11	Yes	1206C	MLCC 4.7 µF X7R 1206 35 V	4.7 µF	TDK
C12	Yes	1206C	MLCC 1 nF X7R 1206 35 V	1 nF	
C13	No	C_FKP2_4.5x6x7.2	polypro 220 pF, >500 V	220 pF, 630 V	Kemet
C14	Yes	1206C	2.2 µF 35 V	2.2 µF	Murata
C15	Yes	1206C	MLCC 2.7 nF X7R 1206 50 V	2.7 nF	
C16	No	C_FKP2_4.5x6x7.2	33 pF, 1000 V, FKP2	33 pF, 1000 V NM	Wima
C17	Yes	1206C	MLCC 68 nF X7R 1206 50 V	68 nF	
C18	Yes	1206C	100 nF 35 V	100 nF	
C19	Yes	C_POL_6032-28_Csize	Tantalum 4.7 µF 35 V	4.7 µF	Vishay
C20	Yes	C_POL_D5	Elco, 10 µF, 35 V	10 µF	Panasonic
C21	Yes	1206C	MLCC 2.2 nF X7R 1206 35 V	2.2 nF NM	
C22	Yes	1206C	47 pF 35 V	47 pF	
C25	Yes	1206C	MLCC 1 nF X7R 1206 35 V	NM	
CY1, CY2	No	C_MKT12..5X4X10	Y2 2.2 nF 250 V PET	Y2 2.2 nF	
CY3, CY4	No	C_MKT12..5X4X10	B81123 2.2 nF 250 V PET	2.2 nF 250 V	Epcos
D1	Yes	D0214AB-W	DIODE VISHAY 3 A 600 V t _{rr} =2.5 µs	S3J	Vishay
D2	No	TO220-2	DIODE 600 V 6 A TO220R2L	IDP06E60	Infineon

300 W general purpose wide-range SMPS PFC + TTF Evaluation Board



Bill of Material (BOM)

Designator	Mount	Footprint	Description	Comment	Manufacturer
D3, D4	Yes	D0214AC	DIODE SMA 600 V 1 A $t_{rr}=1.8 \mu s$	S1J	Vishay
D5, D6	No	TO220_ST	DIODE 2X 15 A 200 V	30CTH02	Vishay
D7	Yes	SOD80	Diode 800 V, 0.5 A	RGL34K	Vishay
D8, D10	Yes	D0214AA	200 V SMB	ES2D	Fairchild
D9, D11, D12	Yes	SOD80	100 V signal, 100 V signal diode, 100 V signal	LL4148	Fairchild
DZ1	Yes	SOD80	12 V 05 W 5% 200 mA SOD80	12 Vz	Vishay
DZ3	Yes	SOD80	18 V 05 W 5% 200 mA	18 Vz	Vishay
EMI1	No	L_EMI 12.5X17.5variante	COMMON MODE CHOKE	B82724J2602N041	Epcos
F1	No	FUSE5X20	FUSE 5 A 232 5X20	5 A	RS
H1	No	PAD		Heatsink	
H1b	No	SK48084 – 84 mm	Heatsink	Heatsink	Fisher Elektronik
I1	Yes	DSO8	INFINEON 600 V gate driver IC, 15 V _{CC} 0.5 A, NO interlock	2EDL05I06BF	Infineon
I2	No	DIP7	INFINEON Flyback	ICE2QR4780Z	
IC1	No	DIP4/10	SFH617A-2	SFH617A-2	Vishay
IC3	Yes	SOT23R	VOLTREG. TL431 1%	TL431A	Texas Instruments
J1	No	CONN7.5mm		CON3	
J2	No	CON2		CON2	
J3	No	CONN SIN 14 - ICE1CS02G CB	ICE1CS02G CB	ICE1CS02G Control Board	
L1	No	L_TOR	OUTPUT CHOKE	0.7 mH Pulse electronics	Pulse
L3	No	L_TOR	Pulse electronics	47 μ H Pulse electronics	Pulse
LED1	Yes	LED - TOPLed	Green Led, TOPLED	Green	OSRAM
Q1	No	TO220_ST	POWER MOSFET	IPP60R190E6	Infineon
Q2, Q3	No	TO220_ST	POWER MOSFET	IPP60R280E6	Infineon
Q4	Yes	SOT323	BJT NPN 50 V hfe=330	BC847CW	Infineon
R1, R3, R4	Yes	1206R	RESISTOR 10K 1206 5%	10K	
R2, R5	Yes	2010	RESISTOR 10R 5% 2010	10R	
R6, R7, R11	Yes	2512R	RESISTOR 0R33 2512 1%	0R33	Panasonic
R8, R9, R10	Yes	2512R	RESISTOR 1R 2512 1%	1R	Panasonic
R12, R13	Yes	1206R	RESISTOR 68K 1206	68K	

300 W general purpose wide-range SMPS PFC + TTF Evaluation Board



Bill of Material (BOM)

Designator	Mount	Footprint	Description	Comment	Manufacturer
			5%		
R14, R15, R28, R29, R46	Yes	1206R	RESISTOR 0R0 1206 5%	0R0	
R16, R26	Yes	1206R	RESISTOR 1K0 1206 5%	1K0	
R17, R21, R37	Yes	1206R	RESISTOR 15K 1206 5%	15k	
R18	Yes	1206R	RESISTOR 22K 1206 5%	22K	
R19	Yes	1206R	RESISTOR 22R 1206 5%	22R	
R20	Yes	1206R	RESISTOR 680R 1206 5%	680R	
R22	Yes	1206R	RESISTOR 3K9 1206 5%	3K9	
R23	Yes	1206R	RESISTOR 2.2K 1206 5%	2.2K	
R24	Yes	1206R	RESISTOR 7K5 1206 5%	7K5	
R25	Yes	2512R	RESISTOR 6R8 2512 5%	6R8	Panasonic
R27, R42, R45	Yes	1206R	RESISTOR 3R3 1206 5%	3R3	
R33	Yes	1206R	RESISTOR 4K3 1206 5%	4K3	
R35	Yes	1206R	RESISTOR 15K 1206 5%	NM	
RT1	No	NTC7.5	NTC THERMISTOR 5 passo 7.5 mm 21 mm diam 8.5 A	B57364S509M	Epcos
TRA1	No	T_ETD34	ETD34 TTF transformer	Pulse electronics	Pulse
TRA2	No	EE10 - 1pri 2sec	Flyback transformer	Pulse electronics	Pulse
VAR1	No	VARISTOR	S10K300	S10K300	Epcos

10 Appendix A: Average and rms values

In typical electric / electronic circuits, voltage $v(t)$ and current $i(t)$ vary as a function of time. If a generic function $x(t)$ repeats with a time period T in steady state ($x(t + T) = x(t)$), then average function value X_{avg} and root-mean square (rms) value X_{rms} can be calculated as:

$$X_{avg} = \frac{1}{T} \cdot \int_0^T x(t) dt \quad \text{Eq 31}$$

$$X_{rms} = \sqrt{\frac{1}{T} \cdot \int_0^T x^2(t) dt} \quad \text{Eq 32}$$

Typically, X_{avg} and X_{rms} are different; only if $x(t)$ is constant, then $X_{av} = X_{rms}$. Standard waveforms (sinusoidal, rectangular and saw-tooth and triangular waves) will be further analyzed. Time origin is arbitrary, as only periodic functions will be analyzed; eventually, offset amplitude values can be easily added by slightly modifying formulas, as shown below.

10.1 Sinusoidal waveform

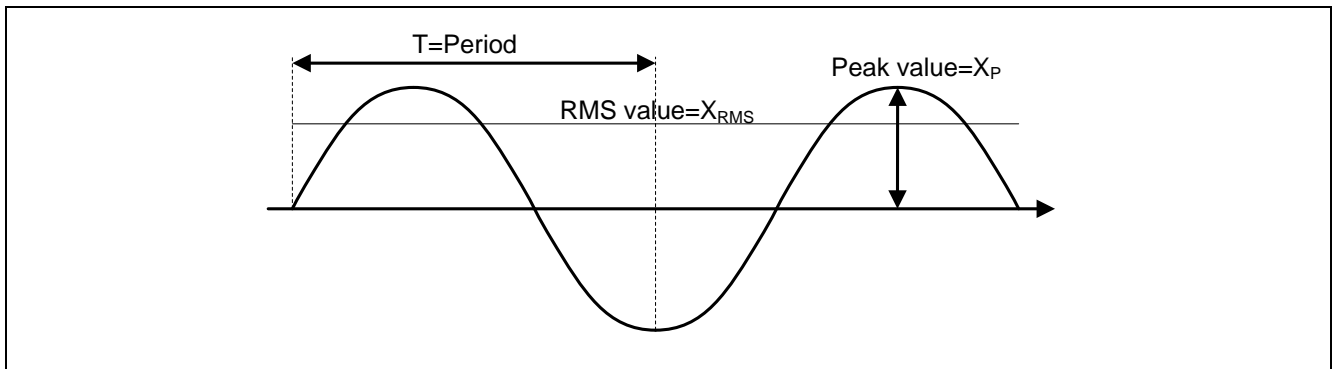

Figure 47 Nomenclature in sinusoidal function

As shown in this Figure 47, it is easy to evaluate average and rms values: average value $X_{avg} = 0$ because there is no offset and sinusoidal waveform is positive for half period ($T / 2$) and negative in a symmetric way. However, rms value of a sinusoidal waveform $x(t) = \sin(t)$ is not 0, as shown below:

$$X_{avg} = \frac{1}{T} \cdot \int_0^T x(t) dt = \frac{1}{T} \cdot \int_0^T X_p \cdot \sin(t) dt = 0 \quad \text{Eq 33}$$

$$X_{rms} = \sqrt{\frac{1}{T} \cdot \int_0^T x^2(t) dt} = \sqrt{\frac{1}{T} \cdot \int_0^T (X_p \cdot \sin(t))^2 dt} = \sqrt{\frac{1}{T} \cdot \frac{1}{2} \cdot X_p^2 \cdot T} = \frac{X_p}{\sqrt{2}} \quad \text{Eq 34}$$

10.2 Rectangular pulse train

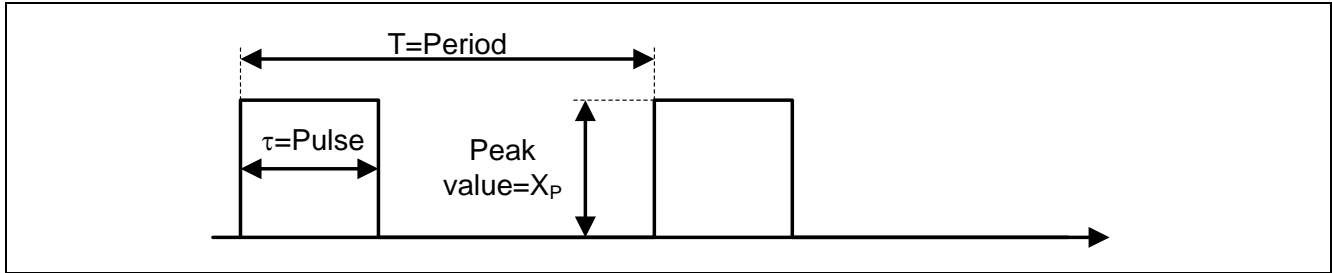

Figure 48 Nomenclature in pulse train function

In this case, duty cycle $D = \tau / T$ makes the difference between average and rms value in a rectangular pulse train: $D = [0, 1]$ and it is easy to understand that if $D = 1$, then $x(t)$ is constant and $x(t) = X_{avg} = X_{rms} = A$. If $D < 1$, then integrals are evaluated between 0 and $\tau = D \cdot T$.

$$X_{avg} = \frac{1}{T} \cdot \int_0^T x(t) dt = \frac{1}{T} \cdot \int_0^{\tau} X_P dt = \frac{1}{T} \cdot X_P \cdot \tau = X_P \cdot D \quad \text{Eq 35}$$

$$X_{rms} = \sqrt{\frac{1}{T} \cdot \int_0^T x^2(t) dt} = \sqrt{\frac{1}{T} \cdot \int_0^{\tau=D \cdot T} X_P^2 dt} = \sqrt{\frac{1}{T} X_P^2 \cdot D \cdot T} = X_P \cdot \sqrt{D} \quad \text{Eq 36}$$

10.3 Sawtooth waveform

Saw-tooth waves can be expressed analytically as:

$$x(t) = X_P \cdot \frac{t}{\tau} \quad \begin{array}{l} 0 < t < \tau = D \cdot T \\ x(t) = 0 \text{ elsewhere} \end{array} \quad \text{Eq 37}$$

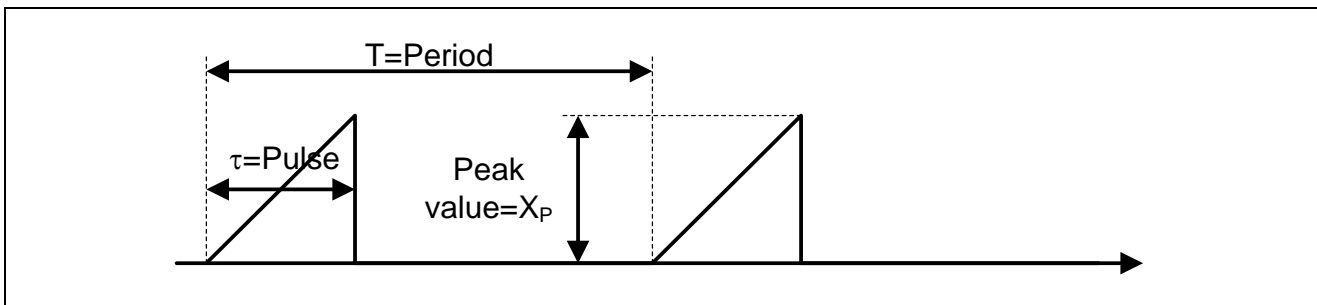

Figure 49 Nomenclature in saw-tooth train function

Hence, X_{avg} and X_{rms} can be calculated as follows:

$$X_{avg} = \frac{1}{T} \cdot \int_0^T x(t) dt = \frac{1}{T} \cdot \int_0^{\tau} X_P \cdot \frac{t}{\tau} dt = \frac{1}{T} \cdot \frac{X_P}{D \cdot T} \cdot \frac{(D \cdot T)^2}{2} = X_P \cdot \frac{D}{2} \quad \text{Eq 38}$$

$$X_{rms} = \sqrt{\frac{1}{T} \cdot \int_0^T x^2(t) dt} = \sqrt{\frac{1}{T} \cdot \int_0^{\tau} X_P^2 \cdot \left(\frac{t}{\tau}\right)^2 dt} = X_P \cdot \sqrt{\frac{D}{3}} \quad \text{Eq 39}$$

If an offset B exists, then:

$$x(t) = X_P \cdot \frac{t}{\tau} + B \quad 0 < t < \tau = D \cdot T \quad \text{Eq 40}$$

$$x(t) = 0 \text{ elsewhere}$$

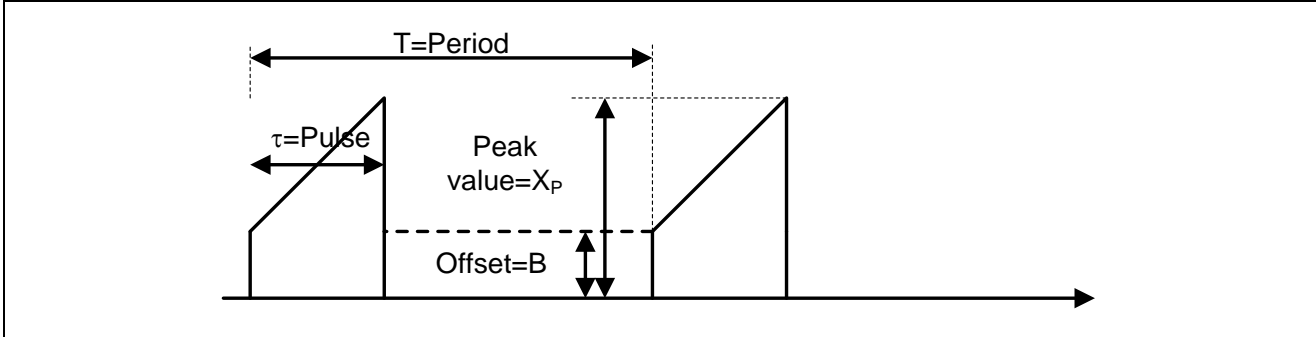

Figure 50 Nomenclature saw-tooth train function with offset

Hence, X_{avg} and X_{rms} can be calculated as follows:

$$X_{avg} = \frac{1}{T} \cdot \int_0^T x(t) dt = \frac{1}{T} \cdot \int_0^\tau \left((X_P - B) \cdot \frac{t}{\tau} + B \right) dt = \frac{D}{2} \cdot (X_P + B) \quad \text{Eq 41}$$

$$X_{rms} = \sqrt{\frac{1}{T} \cdot \int_0^T x^2(t) dt} = \sqrt{\frac{1}{T} \cdot \int_0^\tau \left((X_P - B) \cdot \left(\frac{t}{\tau}\right) + B \right)^2 dt} \quad \text{Eq 42}$$

$$= \sqrt{\frac{D}{3}} \cdot \sqrt{X_P^2 + X_P \cdot B + B^2}$$

10.4 Triangular waveforms

Triangular waves can be expressed as:

$$x(t) = X_P \cdot \frac{t}{\tau} \quad 0 < t < \tau = D \cdot T \quad \text{Eq 43}$$

$$x(t) = -X_P \cdot \frac{t - T}{T - \tau} \quad \tau < t < T$$

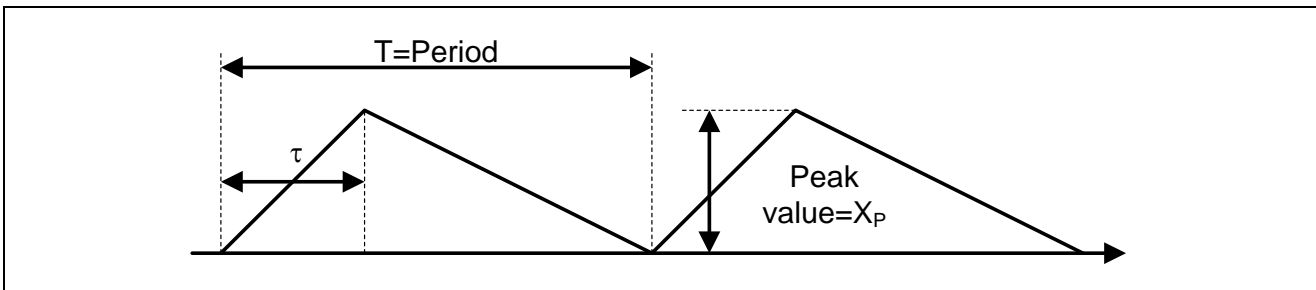

Figure 51 Nomenclature in triangular train function

X_{avg} and X_{rms} can then be calculated as follows:

$$X_{avg} = \frac{1}{T} \cdot \int_0^T x(t) dt = \frac{1}{T} \cdot \left(\int_0^\tau X_P \cdot \frac{t}{\tau} dt + \int_\tau^T -X_P \cdot \frac{t - T}{T - \tau} dt \right) = \frac{X_P}{2} \quad \text{Eq 44}$$

$$X_{rms} = \sqrt{\frac{1}{T} \cdot \int_0^T x^2(t) dt} = \sqrt{\frac{1}{T} \cdot \left[\int_0^\tau X_P^2 \cdot \left(\frac{t}{\tau}\right)^2 dt + \int_\tau^T \left(-X_P \cdot \frac{t-T}{T-\tau}\right)^2 dt \right]} \quad \text{Eq 45}$$

$$= \frac{X_P}{\sqrt{3}}$$

If an offset B exists, then:

$$x(t) = (X_P - B) \cdot \frac{t}{\tau} + B \quad 0 < t < \tau = D \cdot T \quad \text{Eq 46}$$

$$x(t) = -(X_P - B) \cdot \frac{t-T}{T-\tau} + B \quad \tau < t < T$$

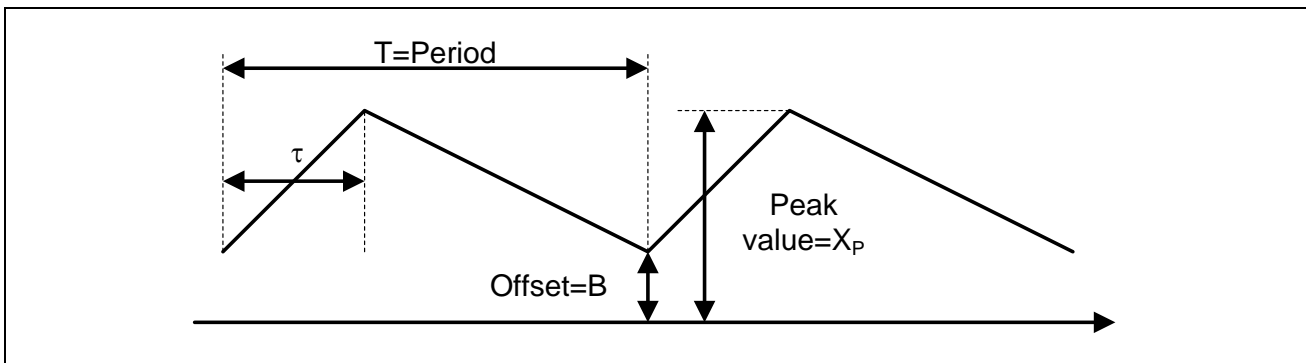

Figure 52 Nomenclature in triangular train function with offset

X_{avg} and X_{rms} can then be calculated as follows:

$$X_{avg} = \frac{1}{T} \cdot \int_0^T x(t) dt \quad \text{Eq 47}$$

$$= \frac{1}{T} \cdot \left(\int_0^\tau (X_P - B) \cdot \frac{t}{\tau} + B dt + \int_\tau^T -(X_P - B) \cdot \frac{t-T}{T-\tau} + B dt \right)$$

$$= \frac{X_P - B}{2} + B = \frac{X_P + B}{2}$$

$$X_{rms} \quad \text{Eq 48}$$

$$= \sqrt{\frac{1}{T} \cdot \left[\int_0^\tau \left((X_P - B) \cdot \left(\frac{t}{\tau}\right) + B \right)^2 dt + \int_\tau^T \left(-(X_P - B) \cdot \frac{t-T}{T-\tau} + B \right)^2 dt \right]}$$

$$= \sqrt{\frac{1}{3} \cdot \sqrt{X_P^2 + X_P \cdot B + B^2}}$$

11 Appendix B: Chart representation of power MOSFET losses in hard switching

MOSFETs selection in DC/DC applications strongly impacts on converter efficiency: transistors choice is mainly determined by power losses, which can be divided in conduction/static and switching/dynamic losses. MOSFETs conduction losses (P_{stat}) have been estimated by multiplying their on-resistance $R_{DS(on)}$ and their squared rms drain current value $I_{D(rms)}$ (see **Eq 49**). Switching losses in MOSFETs (P_{dyn}) have been calculated as described in **Eq 51**, where V_{DS} is the drain-to-source voltage, $E_{oss}(V_{DS})$ represents the energy stored in the output capacitance (C_{oss}) and it is function of V_{DS} , and f_{sw} is the switching frequency. Total power losses (P_{tot}) are then the sum of conduction losses P_{stat} and switching losses P_{dyn} . optimal $R_{DS(on)}$ for MOSFET selection has then been evaluated by total power loss trade-off between P_{stat} and P_{dyn} .

$$P_{stat} = R_{DS(on)} \cdot I_{D(rms)}^2 \quad \text{Eq 49}$$

$$P_{dyn} = E_{oss}(V_{DS}) \cdot f_{sw} \quad \text{Eq 50}$$

$$P_{tot} = R_{DS(on)} \cdot I_{D(rms)}^2 + E_{oss}(V_{DS}) \cdot f_{sw} \quad \text{Eq 51}$$

For a same technology it can be assumed that the product $FOM = R_{DS(on)} \cdot E_{oss}$ is nearly constant while fixing the desired V_{DS} voltage and measurement characteristics.

This exercise is done for CoolMOS™ C6 and CoolMOS™ CE in the following tables by taking the datasheet values.

Then **Eq 51** can be rewritten as follows:

$$FOM = R_{ds(on)} \cdot E_{oss}(V_{DS}) \quad \text{Eq 52}$$

$$P_{tot} = R_{DS(on)} \cdot I_{D(rms)}^2 + E_{oss}(V_{DS}) \cdot f_{sw} = R_{DS(on)} \cdot I_{D(rms)}^2 + \frac{FOM}{R_{DS(on)}} \cdot f_{sw} \quad \text{Eq 53}$$

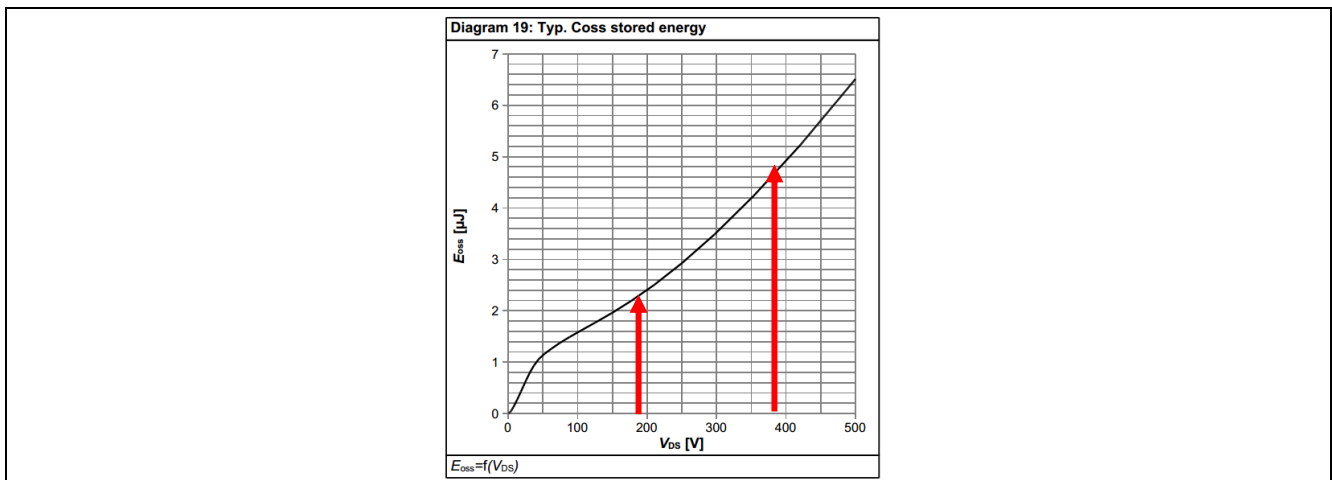

Figure 53 E_{oss} chart for 190 mΩ CoolMOS™ P6 600V IPP60R190P6

Table 13 and Table 14 shows the calculation of indicative FOM from datasheet values.

300 W general purpose wide-range SMPS PFC + TTF Evaluation Board



Appendix B: Chart representation of power MOSFET losses in hard switching

Table 13 $R_{DS(on)}$, E_{oss} (@400 V) and evaluated FOM for 600 V CoolMOS™ P6 transistors

600 V CoolMOS™ P6 power transistor	$R_{DS(on)}$ [mΩ]	E_{oss} (@ 400 V) [μJ]	FOM (400 V) = $R_{DS(on)} \cdot E_{oss}$ [Ω · μJ]
IPP60R125P6	113	7.2	0.81
IPP60R160P6	144	5.7	0.82
IPP60R190P6	171	4.9	0.84
IPP60R230P6	207	4.2	0.87
IPP60R280P6	252	3.5	0.88
IPP60R330P6	297	3	0.89
		Average	0.86

Table 14 $R_{DS(on)}$, E_{oss} (@400 V) and evaluated FOM for 500 V CoolMOS™ CE transistors

500 V CoolMOS™ CE power transistor	$R_{DS(on)}$ [Ω]	E_{oss} (@ 400 V/200 V) [μJ]	FOM (@400 V/200 V) = $R_{DS(on)} \cdot E_{oss}$ [μΩ · J]
IPP50R190CE	0.17	4.4 / 2.3	0.75 / 0.39
IPP50R280CE	0.25	3.2 / 1.6	0.80 / 0.4
IPP50R380CE	0.35	2.5 / 1.2	0.87 / 0.42
IPP50R500CE	0.45	2.0 / 0.95	0.9 / 4.3

Plotting equation **Eq 53** with the corresponding data, produces graphs in Figure 13 on page 15 and Figure 17 on page 20.

Note: It must be clear that the E_{oss} measurement is done in certain conditions, which are of course different from the conditions found in a different design. The purpose of the above mentioned calculation is then to get a draft indication on the expected power losses in order to have a good starting point for the choice of the power mosfet.

Gate resistance and driving, as well as the stray capacitances connected to the mosfet drain will contribute to increase the calculated losses.

Additionally the counterpart freewheeling/rectifier diode, when a path is activated, have a big impact on losses, which are here neglected.

12 References and proposed links

- [1] CoolMOS™ high voltage MOSFETs product main page
www.infineon.com/coolmos
- [2] thinQ™! Silicon Carbide Schottky Diodes main page
www.infineon.com/thinq
- [3] Rapid Silicon Diodes main page
<http://www.infineon.com/cms/en/product/transistor-and-diode/diode/silicon-power-diode/channel.html?channel=ff80808112ab681d0112ab6a527f04a6>
- [4] CoolSET™ auxiliary and SMPS controller ICs main page
www.infineon.com/coolset
- [5] ICE1CS02G application note: “300W Evaluation board using ICE1CS02”:
<http://www.infineon.com/dgdl?folderId=5546d4694909da4801490a2652e6286a&fileId=db3a30431c69a49d011c8e8e3df1048f>
- [6] ICE1CS02G datasheet from Infineon product page
<http://www.infineon.com/dgdl?folderId=5546d4694909da4801490a07012f053b&fileId=db3a30431c69a49d011c8e917a2d0494>
- [7] Addendum to 300 W general purpose wide range SMPS
http://www.infineon.com/dgdl/Infineon-ApplicationNote_Addendum_to_300W_general_purpose_wide-range_SMPS-AN-v01_00-EN.pdf?fileId=5546d46250cc1fdf01513392e96c3537

Revision History

Major changes since the last revision

Page or Reference	Description of change
--	First Release
Revision 1.1	Alternative solution for daughterboard added; See Note on page 1

Trademarks of Infineon Technologies AG

AURIX™, C166™, CanPAK™, CIPOST™, CIPURSE™, CoolGaN™, CoolMOS™, CoolSET™, CoolSiC™, CORECONTROL™, CROSSAVE™, DAVE™, DI-POL™, DrBLADE™, EasyPIM™, EconoBRIDGE™, EconoDUAL™, EconoPACK™, EconoPIM™, EiceDRIVER™, eupec™, FCOS™, HITFET™, HybridPACK™, ISOFACE™, IsoPACK™, i-Wafer™, MIPAQ™, ModSTACK™, my-d™, NovalithIC™, OmniTune™, OPTIGA™, OptiMOS™, ORIGA™, POWERCODE™, PRIMARION™, PrimePACK™, PrimeSTACK™, PROFET™, PRO-SIL™, RASIC™, REAL3™, ReverSave™, SatRIC™, SIEGET™, SIPMOS™, SmartLEWIS™, SOLID FLASH™, SPOC™, TEMPFET™, thinQ™, TRENCHSTOP™, TriCore™.

Other Trademarks

Advance Design System™ (ADS) of Agilent Technologies, AMBA™, ARM™, MULTI-ICE™, KEIL™, PRIMECELL™, REALVIEW™, THUMB™, μVision™ of ARM Limited, UK. ANSI™ of American National Standards Institute. AUTOSAR™ of AUTOSAR development partnership. Bluetooth™ of Bluetooth SIG Inc. CAT-iq™ of DECT Forum. COLOSSUS™, FirstGPS™ of Trimble Navigation Ltd. EMV™ of EMVCo, LLC (Visa Holdings Inc.). EPCOS™ of Epcos AG. FLEXGO™ of Microsoft Corporation. HYPERTERMINAL™ of Hilgraeve Incorporated. MCS™ of Intel Corp. IEC™ of Commission Electrotechnique Internationale. IrDA™ of Infrared Data Association Corporation. ISO™ of INTERNATIONAL ORGANIZATION FOR STANDARDIZATION. MATLAB™ of MathWorks, Inc. MAXIM™ of Maxim Integrated Products, Inc. MICROTEC™, NUCLEUS™ of Mentor Graphics Corporation. MIPI™ of MIPI Alliance, Inc. MIPS™ of MIPS Technologies, Inc., USA. muRata™ of MURATA MANUFACTURING CO., MICROWAVE OFFICE™ (MWO) of Applied Wave Research Inc., OmniVision™ of OmniVision Technologies, Inc. Openwave™ of Openwave Systems Inc. RED HAT™ of Red Hat, Inc. RFMD™ of RF Micro Devices, Inc. SIRIUS™ of Sirius Satellite Radio Inc. SOLARIS™ of Sun Microsystems, Inc. SPANSION™ of Spansion LLC Ltd. Symbian™ of Symbian Software Limited. TAIYO YUDEN™ of Taiyo Yuden Co. TEAKLITE™ of CEVA, Inc. TEKTRONIX™ of Tektronix Inc. TOKO™ of TOKO KABUSHIKI KAISHA TA. UNIX™ of X/Open Company Limited. VERILOG™, PALLADIUM™ of Cadence Design Systems, Inc. VLYNQ™ of Texas Instruments Incorporated. VXWORKS™, WIND RIVER™ of WIND RIVER SYSTEMS, INC. ZETEX™ of Diodes Zetex Limited.

Last Trademarks Update 2014-07-17

www.infineon.com

Edition 2015-10-20

Published by

Infineon Technologies AG

81726 Munich, Germany

© 2016 Infineon Technologies AG.

All Rights Reserved.

Do you have a question about any aspect of this document?

Email: erratum@infineon.com

Document reference

ANEVAL_201410_PL52_002

Legal Disclaimer

THE INFORMATION GIVEN IN THIS APPLICATION NOTE (INCLUDING BUT NOT LIMITED TO CONTENTS OF REFERENCED WEBSITES) IS GIVEN AS A HINT FOR THE IMPLEMENTATION OF THE INFINEON TECHNOLOGIES COMPONENT ONLY AND SHALL NOT BE REGARDED AS ANY DESCRIPTION OR WARRANTY OF A CERTAIN FUNCTIONALITY, CONDITION OR QUALITY OF THE INFINEON TECHNOLOGIES COMPONENT. THE RECIPIENT OF THIS APPLICATION NOTE MUST VERIFY ANY FUNCTION DESCRIBED HEREIN IN THE REAL APPLICATION. INFINEON TECHNOLOGIES HEREBY DISCLAIMS ANY AND ALL WARRANTIES AND LIABILITIES OF ANY KIND (INCLUDING WITHOUT LIMITATION WARRANTIES OF NON-INFRINGEMENT OF INTELLECTUAL PROPERTY RIGHTS OF ANY THIRD PARTY) WITH RESPECT TO ANY AND ALL INFORMATION GIVEN IN THIS APPLICATION NOTE.

Information

For further information on technology, delivery terms and conditions and prices, please contact the nearest Infineon Technologies Office (www.infineon.com).

Warnings

Due to technical requirements, components may contain dangerous substances. For information on the types in question, please contact the nearest Infineon Technologies Office. Infineon Technologies components may be used in life-support devices or systems only with the express written approval of Infineon Technologies, if a failure of such components can reasonably be expected to cause the failure of that life-support device or system or to affect the safety or effectiveness of that device or system. Life support devices or systems are intended to be implanted in the human body or to support and/or maintain and sustain and/or protect human life. If they fail, it is reasonable to assume that the health of the user or other persons may be endangered.