



Is Now Part of



**ON Semiconductor®**

To learn more about ON Semiconductor, please visit our website at  
[www.onsemi.com](http://www.onsemi.com)

ON Semiconductor and the ON Semiconductor logo are trademarks of Semiconductor Components Industries, LLC dba ON Semiconductor or its subsidiaries in the United States and/or other countries. ON Semiconductor owns the rights to a number of patents, trademarks, copyrights, trade secrets, and other intellectual property. A listing of ON Semiconductor's product/patent coverage may be accessed at [www.onsemi.com/site/pdf/Patent-Marking.pdf](http://www.onsemi.com/site/pdf/Patent-Marking.pdf). ON Semiconductor reserves the right to make changes without further notice to any products herein. ON Semiconductor makes no warranty, representation or guarantee regarding the suitability of its products for any particular purpose, nor does ON Semiconductor assume any liability arising out of the application or use of any product or circuit, and specifically disclaims any and all liability, including without limitation special, consequential or incidental damages. Buyer is responsible for its products and applications using ON Semiconductor products, including compliance with all laws, regulations and safety requirements or standards, regardless of any support or applications information provided by ON Semiconductor. "Typical" parameters which may be provided in ON Semiconductor data sheets and/or specifications can and do vary in different applications and actual performance may vary over time. All operating parameters, including "Typicals" must be validated for each customer application by customer's technical experts. ON Semiconductor does not convey any license under its patent rights nor the rights of others. ON Semiconductor products are not designed, intended, or authorized for use as a critical component in life support systems or any FDA Class 3 medical devices or medical devices with a same or similar classification in a foreign jurisdiction or any devices intended for implantation in the human body. Should Buyer purchase or use ON Semiconductor products for any such unintended or unauthorized application, Buyer shall indemnify and hold ON Semiconductor and its officers, employees, subsidiaries, affiliates, and distributors harmless against all claims, costs, damages, and expenses, and reasonable attorney fees arising out of, directly or indirectly, any claim of personal injury or death associated with such unintended or unauthorized use, even if such claim alleges that ON Semiconductor was negligent regarding the design or manufacture of the part. ON Semiconductor is an Equal Opportunity/Affirmative Action Employer. This literature is subject to all applicable copyright laws and is not for resale in any manner.

## ISL9R860P2, ISL9R860S3ST

### 8 A, 600 V, STEALTH™ Diode

#### Features

- Stealth Recovery  $t_{rr} = 28$  ns (@  $I_F = 8$  A)
- Max Forward Voltage,  $V_F = 2.4$  V (@  $T_C = 25^\circ\text{C}$ )
- 600 V Reverse Voltage and High Reliability
- Avalanche Energy Rated
- RoHS Compliant

#### Applications

- SMPS FWD
- Hard Switched PFC Boost Diode
- UPS Free Wheeling Diode
- Motor Drive FWD
- Snubber Diode

#### Description

The ISL9R860P2, ISL9R860S3ST is a STEALTH™ diode optimized for low loss performance in high frequency hard switched applications. The STEALTH™ family exhibits low reverse recovery current ( $I_{RR}$ ) and exceptionally soft recovery under typical operating conditions. This device is intended for use as a free wheeling or boost diode in power supplies and other power switching applications. The low  $I_{RR}$  and short ta phase reduce loss in switching transistors. The soft recovery minimizes ringing, expanding the range of conditions under which the diode may be operated without the use of additional snubber circuitry. Consider using the STEALTH™ diode with an SMPS IGBT to provide the most efficient and highest power density design at lower cost.

#### Package

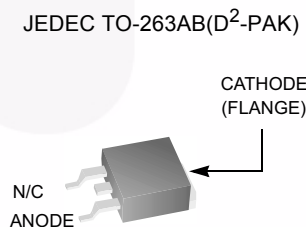
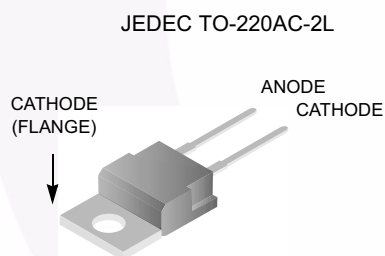

#### Symbol



#### Device Maximum Ratings $T_C = 25^\circ\text{C}$ unless otherwise noted

Symbol	Parameter	Ratings	Unit
$V_{RRM}$	Peak Repetitive Reverse Voltage	600	V
$V_{RWM}$	Working Peak Reverse Voltage	600	V
$V_R$	DC Blocking Voltage	600	V
$I_{F(AV)}$	Average Rectified Forward Current ( $T_C = 147^\circ\text{C}$ )	8	A
$I_{FRM}$	Repetitive Peak Surge Current (20kHz Square Wave)	16	A
$I_{FSM}$	Nonrepetitive Peak Surge Current (Halfwave 1 Phase 60Hz)	100	A
$P_D$	Power Dissipation	85	W
$E_{AVL}$	Avalanche Energy (1 A, 40 mH)	20	mJ
$T_J, T_{STG}$	Operating and Storage Temperature Range	-55 to 175	$^\circ\text{C}$
$T_L$	Maximum Temperature for Soldering	300	$^\circ\text{C}$
$T_{PKG}$	Leads at 0.063in (1.6mm) from Case for 10s Package Body for 10s, See Techbrief TB334	260	$^\circ\text{C}$

CAUTION: Stresses above those listed in "Absolute Maximum Ratings" may cause permanent damage to the device. This is a stress only rating and operation of the device at these or any other conditions above those indicated in the operational sections of this specification is not implied.

### Package Marking and Ordering Information

Part Number	Top Mark	Package	Packing Method	Reel Size	Tape Width	Quantity
ISL9R860P2	ISL9R860P2	TO-220AC-2L	Tube	N/A	N/A	50
ISL9R860S3ST	ISL9R860S3ST	TO-263AB(D <sup>2</sup> -PAK)	Reel	13" Dia	24mm	800

### Electrical Characteristics $T_C = 25^\circ\text{C}$ unless otherwise noted

Symbol	Parameter	Test Conditions	Min	Typ	Max	Unit
--------	-----------	-----------------	-----	-----	-----	------

#### Off State Characteristics

$I_R$	Instantaneous Reverse Current	$V_R = 600\text{ V}$	$T_C = 25^\circ\text{C}$	-	-	100	$\mu\text{A}$
			$T_C = 125^\circ\text{C}$	-	-	1.0	$\text{mA}$

#### On State Characteristics

$V_F$	Instantaneous Forward Voltage	$I_F = 8\text{ A}$	$T_C = 25^\circ\text{C}$	-	2.0	2.4	$\text{V}$
			$T_C = 125^\circ\text{C}$	-	1.6	2.0	$\text{V}$

#### Dynamic Characteristics

$C_J$	Junction Capacitance	$V_R = 10\text{ V}, I_F = 0\text{ A}$	-	30	-	$\text{pF}$
-------	----------------------	---------------------------------------	---	----	---	-------------

#### Switching Characteristics

$t_{rr}$	Reverse Recovery Time	$I_F = 1\text{ A}, di_F/dt = 100\text{ A}/\mu\text{s}, V_R = 30\text{ V}$	-	18	25	$\text{ns}$
		$I_F = 8\text{ A}, di_F/dt = 100\text{ A}/\mu\text{s}, V_R = 30\text{ V}$	-	21	30	$\text{ns}$
$t_{rr}$	Reverse Recovery Time	$I_F = 8\text{ A}$	-	28	-	$\text{ns}$
$I_{rr}$	Reverse Recovery Current	$di_F/dt = 200\text{ A}/\mu\text{s}$	-	3.2	-	$\text{A}$
$Q_{rr}$	Reverse Recovery Charge	$V_R = 390\text{ V}, T_C = 25^\circ\text{C}$	-	50	-	$\text{nC}$
$t_{rr}$	Reverse Recovery Time	$I_F = 8\text{ A}$	-	77	-	$\text{ns}$
S	Softness Factor ( $t_b/t_a$ )	$di_F/dt = 200\text{ A}/\mu\text{s}$	-	3.7	-	
$I_{rr}$	Reverse Recovery Current	$V_R = 390\text{ V}$	-	3.4	-	$\text{A}$
$Q_{rr}$	Reverse Recovery Charge	$T_C = 125^\circ\text{C}$	-	150	-	$\text{nC}$
$t_{rr}$	Reverse Recovery Time	$I_F = 8\text{ A}$	-	53	-	$\text{ns}$
S	Softness Factor ( $t_b/t_a$ )	$di_F/dt = 600\text{ A}/\mu\text{s}$	-	2.5	-	
$I_{rr}$	Reverse Recovery Current	$V_R = 390\text{ V}$	-	6.5	-	$\text{A}$
$Q_{rr}$	Reverse Recovery Charge	$T_C = 125^\circ\text{C}$	-	195	-	$\text{nC}$
$dI_M/dt$	Maximum $di/dt$ during $t_b$		-	500	-	$\text{A}/\mu\text{s}$

#### Thermal Characteristics

$R_{\theta JC}$	Thermal Resistance Junction to Case		-	-	1.75	$^\circ\text{C}/\text{W}$
$R_{\theta JA}$	Thermal Resistance Junction to Ambient	TO-220	-	-	62	$^\circ\text{C}/\text{W}$
$R_{\theta JA}$	Thermal Resistance Junction to Ambient	TO-263	-	-	62	$^\circ\text{C}/\text{W}$

Typical Performance Curves

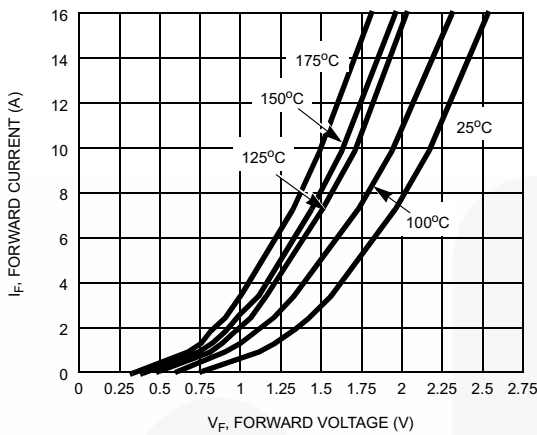

Figure 1. Forward Current vs Forward Voltage

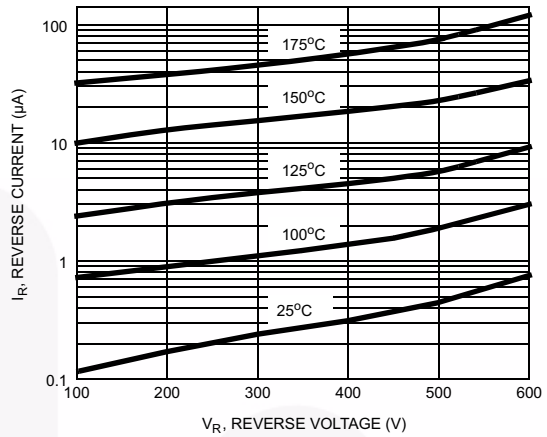

Figure 2. Reverse Current vs Reverse Voltage

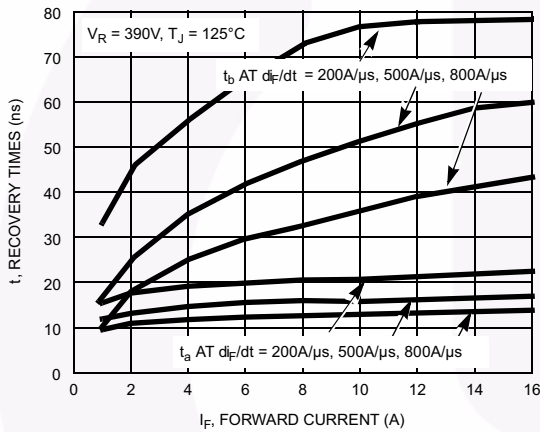

Figure 3.  $t_a$  and  $t_b$  Curves vs Forward Current

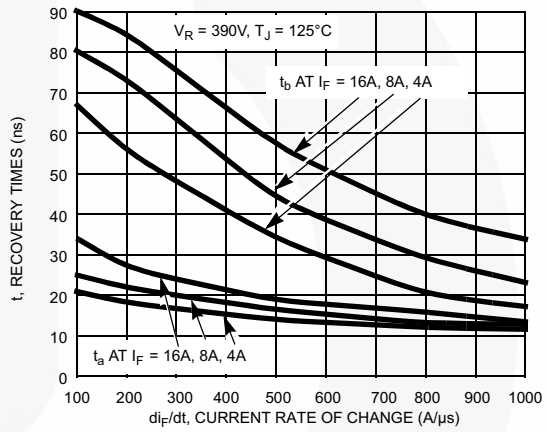

Figure 4.  $t_a$  and  $t_b$  Curves vs  $di_F/dt$

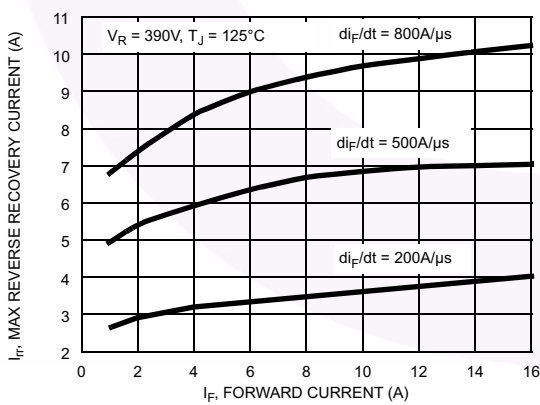

Figure 5. Maximum Reverse Recovery Current vs Forward Current

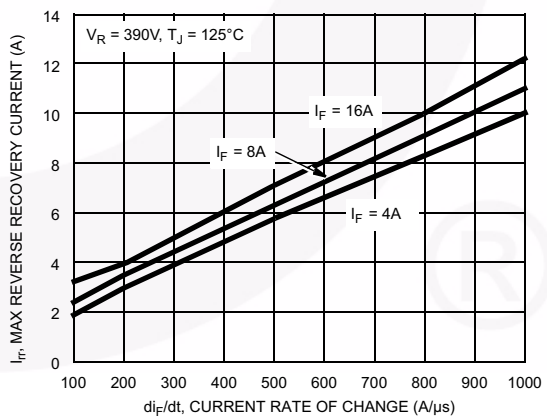

Figure 6. Maximum Reverse Recovery Current vs  $di_F/dt$

Typical Performance Curves (Continued)

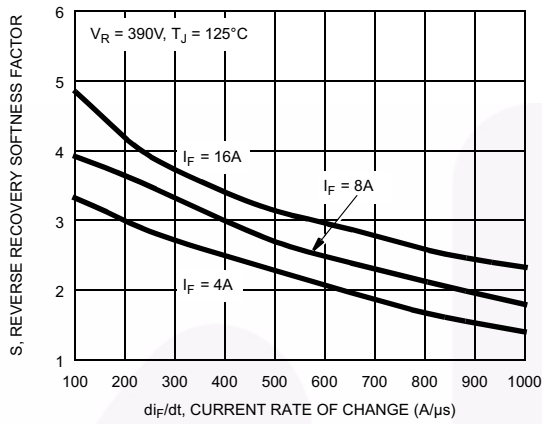

Figure 7. Reverse Recovery Softness Factor vs  $di_F/dt$

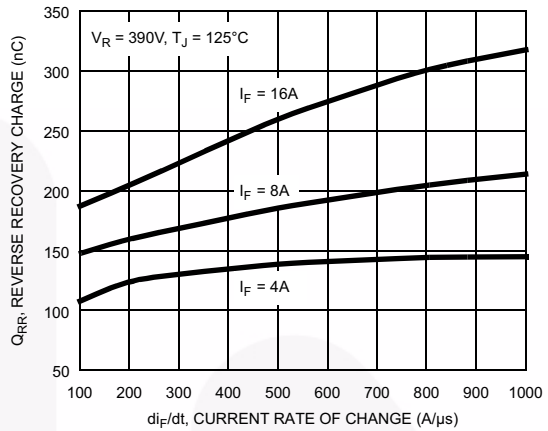

Figure 8. Reverse Recovery Charge vs  $di_F/dt$

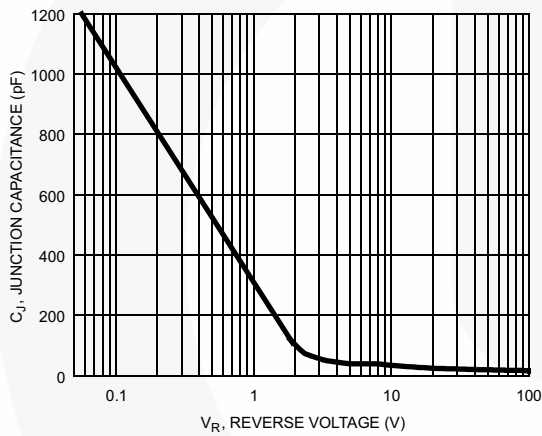

Figure 9. Junction Capacitance vs Reverse Voltage

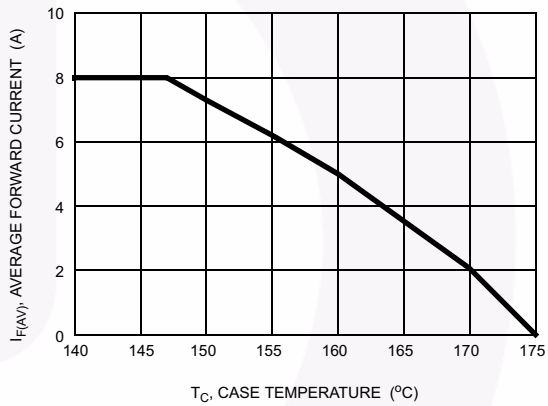

Figure 10. DC Current Derating Curve

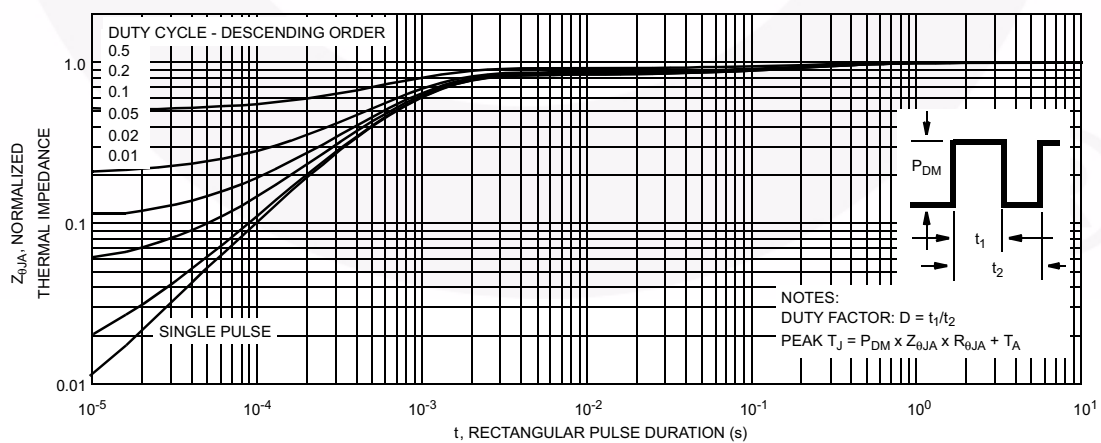

Figure 11. Normalized Maximum Transient Thermal Impedance

Test Circuits and Waveforms

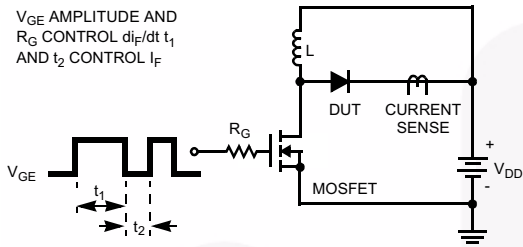

Figure 12.  $t_{rr}$  Test Circuit

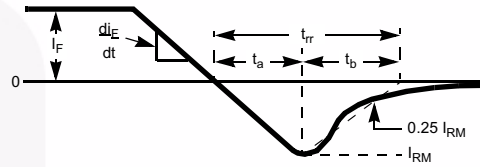

Figure 13.  $t_{rr}$  Waveforms and Definitions

$I = 1A$   
 $L = 40mH$   
 $R < 0.1\Omega$   
 $V_{DD} = 50V$   
 $E_{AVL} = 1/2LI^2 [V_{R(AVL)}/(V_{R(AVL)} - V_{DD})]$   
 $Q_1 = IGBT (BV_{CES} > DUT V_{R(AVL)})$

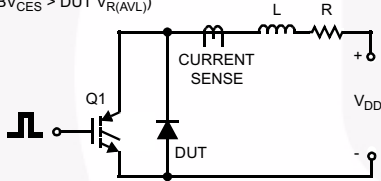

Figure 14. Avalanche Energy Test Circuit

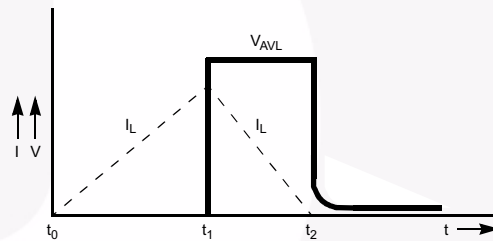
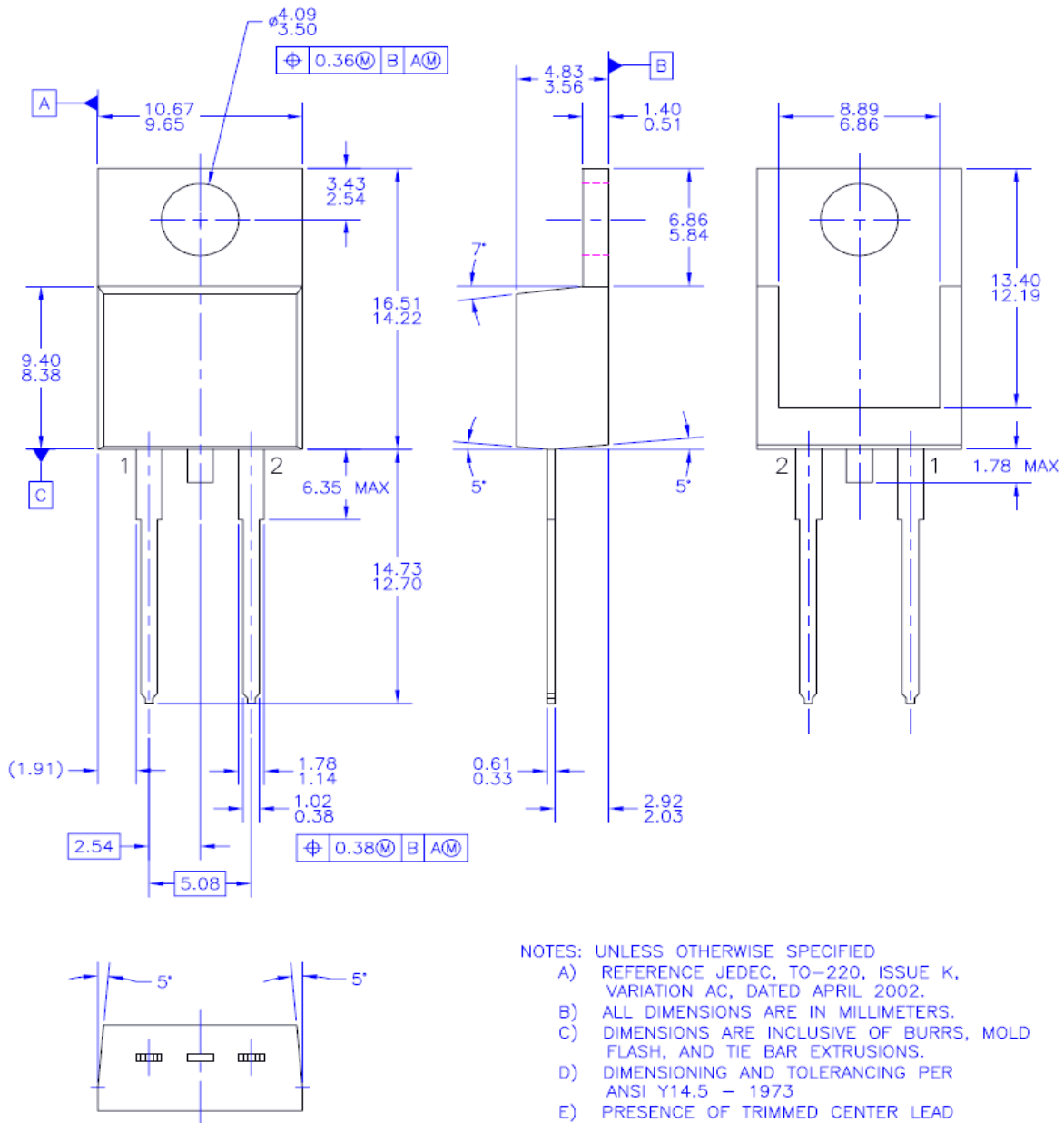

Figure 15. Avalanche Current and Voltage Waveforms

**Mechanical Dimensions**



**Figure 16. TO-220 2L - 2LD, TO220, JEDEC TO-220 VARIATION AC**

Package drawings are provided as a service to customers considering Fairchild components. Drawings may change in any manner without notice. Please note the revision and/or date on the drawing and contact a Fairchild Semiconductor representative to verify or obtain the most recent revision. Package specifications do not expand the terms of Fairchild's worldwide terms and conditions, specifically the warranty therein, which covers Fairchild products.

Always visit Fairchild Semiconductor's online packaging area for the most recent package drawings:

[http://www.fairchildsemi.com/package/packageDetails.html?id=PN\\_TT220-0B2](http://www.fairchildsemi.com/package/packageDetails.html?id=PN_TT220-0B2)

Package Dimensions

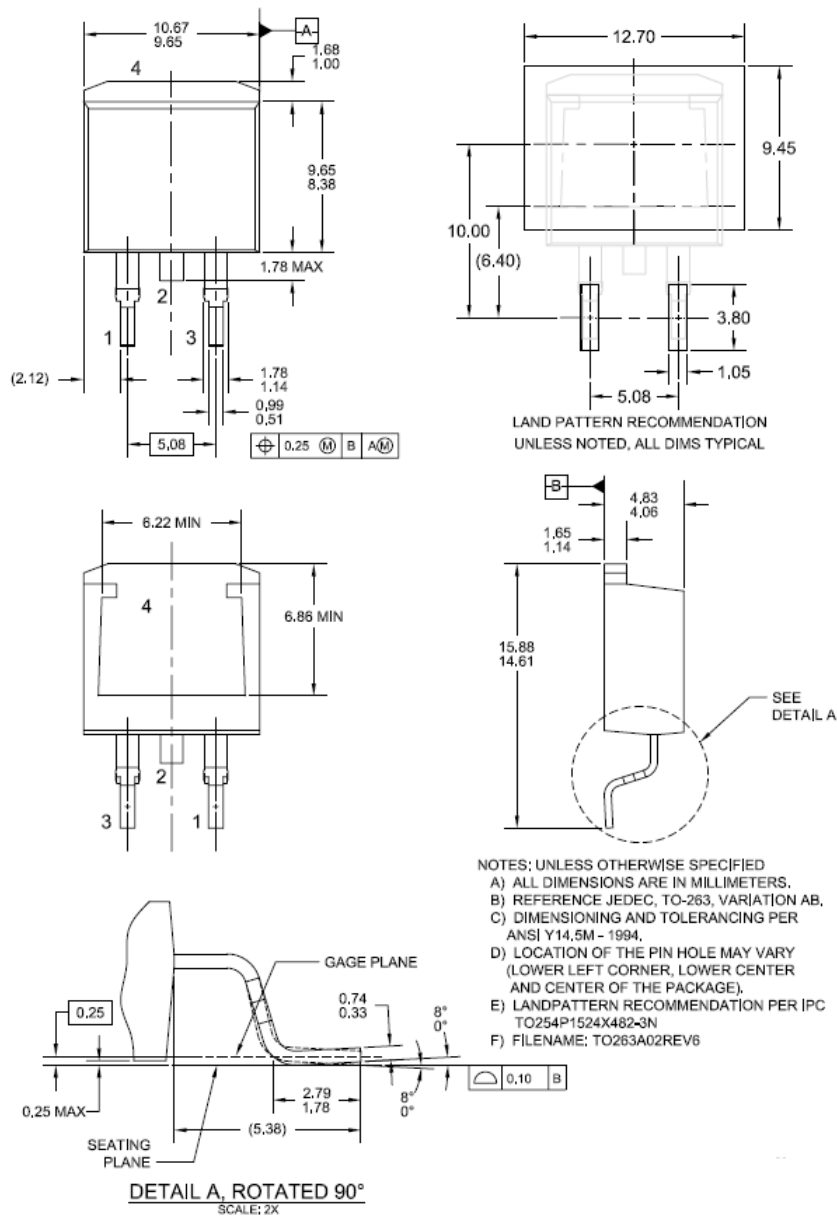

Figure 17. TO-263 2L (D2PAK) - 2LD, TO263, SURFACE MOUNT

Package drawings are provided as a service to customers considering Fairchild components. Drawings may change in any manner without notice. Please note the revision and/or date on the drawing and contact a Fairchild Semiconductor representative to verify or obtain the most recent revision. Package specifications do not expand the terms of Fairchild's worldwide terms and conditions, specifically the warranty therein, which covers Fairchild products.

Always visit Fairchild Semiconductor's online packaging area for the most recent package drawings:



[http://www.fairchildsemi.com/package/packageDetails.html?id=PN\\_TT263-002](http://www.fairchildsemi.com/package/packageDetails.html?id=PN_TT263-002)





**TRADEMARKS**

The following includes registered and unregistered trademarks and service marks, owned by Fairchild Semiconductor and/or its global subsidiaries, and is not intended to be an exhaustive list of all such trademarks.

- |   |   |                            |   |
|---|---|----------------------------|---|
| AccuPower™  | F-PFST™   | PowerTrench®               | Sync-Lock™  |
| AX-CAP®*  | FRFET®  | PowerXS™                   | SYSTEM®*  |
| BitSiC™   | Global Power ResourceSM                         | Programmable Active Droop™ | GENERAL   |
| Build it Now™   | GreenBridge™                                    | QFET®                      | TinyBoost®  |
| CorePLUS™   | Green FPS™                                      | QS™                        | TinyBuck®   |
| CorePOWER™  | Green FPS™ e-Series™                            | Quiet Series™              | TinyCalc™   |
| CROSSVOLT™  | Gmax™   | RapidConfigure™            | TinyLogic®  |
| CTL™  | GTO™  |                            | TINYOPTO™   |
| Current Transfer Logic™   | IntelliMAX™                                     |                            | TinyPower™  |
| DEUXPEED®   | ISOPLANAR™                                      |                            | TinyPWM™  |
| Dual Cool™  | Marking Small Speakers Sound Louder and Better™ |                            | TinyWire™   |
| EcoSPARK®   | MegaBuck™                                       |                            | TranSiC™  |
| EfficientMax™   | MICROCOUPLER™                                   |                            | TriFault Detect™  |
| ESBC™   | MicroFET™                                       |                            | TRUECURRENT®*   |
|  | MicroPak™                                       |                            | µSerDes™  |
| Fairchild®  | MicroPak2™                                      |                            |  |
| Fairchild Semiconductor®  | MillerDrive™                                    |                            | UHC®  |
| FACT Quiet Series™  | MotionMax™                                      |                            | Ultra FRFET™  |
| FACT®   | mWSaver®  |                            | UniFET™   |
| FAST®   | OptoHiT™  |                            | VCX™  |
| FastvCore™  | OPTOLOGIC®                                      |                            | VisualMax™  |
| FETBench™   | OPTOPLANAR®                                     |                            | VoltagePlus™  |
| FPS™  |   |                            | XS™   |

\*Trademarks of System General Corporation, used under license by Fairchild Semiconductor.

**DISCLAIMER**

FAIRCHILD SEMICONDUCTOR RESERVES THE RIGHT TO MAKE CHANGES WITHOUT FURTHER NOTICE TO ANY PRODUCTS HEREIN TO IMPROVE RELIABILITY, FUNCTION, OR DESIGN. FAIRCHILD DOES NOT ASSUME ANY LIABILITY ARISING OUT OF THE APPLICATION OR USE OF ANY PRODUCT OR CIRCUIT DESCRIBED HEREIN; NEITHER DOES IT CONVEY ANY LICENSE UNDER ITS PATENT RIGHTS, NOR THE RIGHTS OF OTHERS. THESE SPECIFICATIONS DO NOT EXPAND THE TERMS OF FAIRCHILD'S WORLDWIDE TERMS AND CONDITIONS, SPECIFICALLY THE WARRANTY THEREIN, WHICH COVERS THESE PRODUCTS.

**LIFE SUPPORT POLICY**

FAIRCHILD'S PRODUCTS ARE NOT AUTHORIZED FOR USE AS CRITICAL COMPONENTS IN LIFE SUPPORT DEVICES OR SYSTEMS WITHOUT THE EXPRESS WRITTEN APPROVAL OF FAIRCHILD SEMICONDUCTOR CORPORATION.

As used here in:

- Life support devices or systems are devices or systems which, (a) are intended for surgical implant into the body or (b) support or sustain life, and (c) whose failure to perform when properly used in accordance with instructions for use provided in the labeling, can be reasonably expected to result in a significant injury of the user.
- A critical component in any component of a life support, device, or system whose failure to perform can be reasonably expected to cause the failure of the life support device or system, or to affect its safety or effectiveness.

**ANTI-COUNTERFEITING POLICY**

Fairchild Semiconductor Corporation's Anti-Counterfeiting Policy. Fairchild's Anti-Counterfeiting Policy is also stated on our external website, www.Fairchildsemi.com, under Sales Support. Counterfeiting of semiconductor parts is a growing problem in the industry. All manufactures of semiconductor products are experiencing counterfeiting of their parts. Customers who inadvertently purchase counterfeit parts experience many problems such as loss of brand reputation, substandard performance, failed application, and increased cost of production and manufacturing delays. Fairchild is taking strong measures to protect ourselves and our customers from the proliferation of counterfeit parts. Fairchild strongly encourages customers to purchase Fairchild parts either directly from Fairchild or from Authorized Fairchild Distributors who are listed by country on our web page cited above. Products customers buy either from Fairchild directly or from Authorized Fairchild Distributors are genuine parts, have full traceability, meet Fairchild's quality standards for handling and storage and provide access to Fairchild's full range of up-to-date technical and product information. Fairchild and our Authorized Distributors will stand behind all warranties and will appropriately address and warranty issues that may arise. Fairchild will not provide any warranty coverage or other assistance for parts bought from Unauthorized Sources. Fairchild is committed to combat this global problem and encourage our customers to do their part in stopping this practice by buying direct or from authorized distributors.

**PRODUCT STATUS DEFINITIONS**

Definition of Terms

Datasheet Identification	Product Status	Definition
Advance Information	Formative / In Design	Datasheet contains the design specifications for product development. Specifications may change in any manner without notice.
Preliminary	First Production	Datasheet contains preliminary data; supplementary data will be published at a later date. Fairchild Semiconductor reserves the right to make changes at any time without notice to improve design.
No Identification Needed	Full Production	Datasheet contains final specifications. Fairchild Semiconductor reserves the right to make changes at any time without notice to improve the design.
Obsolete	Not In Production	Datasheet contains specifications on a product that is discontinued by Fairchild Semiconductor. The datasheet is for reference information only.

Rev. I66

ON Semiconductor and  are trademarks of Semiconductor Components Industries, LLC dba ON Semiconductor or its subsidiaries in the United States and/or other countries. ON Semiconductor owns the rights to a number of patents, trademarks, copyrights, trade secrets, and other intellectual property. A listing of ON Semiconductor's product/patent coverage may be accessed at [www.onsemi.com/site/pdf/Patent-Marking.pdf](http://www.onsemi.com/site/pdf/Patent-Marking.pdf). ON Semiconductor reserves the right to make changes without further notice to any products herein. ON Semiconductor makes no warranty, representation or guarantee regarding the suitability of its products for any particular purpose, nor does ON Semiconductor assume any liability arising out of the application or use of any product or circuit, and specifically disclaims any and all liability, including without limitation special, consequential or incidental damages. Buyer is responsible for its products and applications using ON Semiconductor products, including compliance with all laws, regulations and safety requirements or standards, regardless of any support or applications information provided by ON Semiconductor. "Typical" parameters which may be provided in ON Semiconductor data sheets and/or specifications can and do vary in different applications and actual performance may vary over time. All operating parameters, including "Typicals" must be validated for each customer application by customer's technical experts. ON Semiconductor does not convey any license under its patent rights nor the rights of others. ON Semiconductor products are not designed, intended, or authorized for use as a critical component in life support systems or any FDA Class 3 medical devices or medical devices with a same or similar classification in a foreign jurisdiction or any devices intended for implantation in the human body. Should Buyer purchase or use ON Semiconductor products for any such unintended or unauthorized application, Buyer shall indemnify and hold ON Semiconductor and its officers, employees, subsidiaries, affiliates, and distributors harmless against all claims, costs, damages, and expenses, and reasonable attorney fees arising out of, directly or indirectly, any claim of personal injury or death associated with such unintended or unauthorized use, even if such claim alleges that ON Semiconductor was negligent regarding the design or manufacture of the part. ON Semiconductor is an Equal Opportunity/Affirmative Action Employer. This literature is subject to all applicable copyright laws and is not for resale in any manner.

## PUBLICATION ORDERING INFORMATION

### LITERATURE FULFILLMENT:

Literature Distribution Center for ON Semiconductor  
19521 E. 32nd Pkwy, Aurora, Colorado 80011 USA  
**Phone:** 303-675-2175 or 800-344-3860 Toll Free USA/Canada  
**Fax:** 303-675-2176 or 800-344-3867 Toll Free USA/Canada  
**Email:** [orderlit@onsemi.com](mailto:orderlit@onsemi.com)

**N. American Technical Support:** 800-282-9855 Toll Free  
USA/Canada  
**Europe, Middle East and Africa Technical Support:**  
Phone: 421 33 790 2910  
**Japan Customer Focus Center**  
Phone: 81-3-5817-1050

**ON Semiconductor Website:** [www.onsemi.com](http://www.onsemi.com)  
**Order Literature:** <http://www.onsemi.com/orderlit>  
For additional information, please contact your local  
Sales Representative