



Is Now Part of



ON Semiconductor®

To learn more about ON Semiconductor, please visit our website at
www.onsemi.com

ON Semiconductor and the ON Semiconductor logo are trademarks of Semiconductor Components Industries, LLC dba ON Semiconductor or its subsidiaries in the United States and/or other countries. ON Semiconductor owns the rights to a number of patents, trademarks, copyrights, trade secrets, and other intellectual property. A listing of ON Semiconductor's product/patent coverage may be accessed at www.onsemi.com/site/pdf/Patent-Marking.pdf. ON Semiconductor reserves the right to make changes without further notice to any products herein. ON Semiconductor makes no warranty, representation or guarantee regarding the suitability of its products for any particular purpose, nor does ON Semiconductor assume any liability arising out of the application or use of any product or circuit, and specifically disclaims any and all liability, including without limitation special, consequential or incidental damages. Buyer is responsible for its products and applications using ON Semiconductor products, including compliance with all laws, regulations and safety requirements or standards, regardless of any support or applications information provided by ON Semiconductor. "Typical" parameters which may be provided in ON Semiconductor data sheets and/or specifications can and do vary in different applications and actual performance may vary over time. All operating parameters, including "Typicals" must be validated for each customer application by customer's technical experts. ON Semiconductor does not convey any license under its patent rights nor the rights of others. ON Semiconductor products are not designed, intended, or authorized for use as a critical component in life support systems or any FDA Class 3 medical devices or medical devices with a same or similar classification in a foreign jurisdiction or any devices intended for implantation in the human body. Should Buyer purchase or use ON Semiconductor products for any such unintended or unauthorized application, Buyer shall indemnify and hold ON Semiconductor and its officers, employees, subsidiaries, affiliates, and distributors harmless against all claims, costs, damages, and expenses, and reasonable attorney fees arising out of, directly or indirectly, any claim of personal injury or death associated with such unintended or unauthorized use, even if such claim alleges that ON Semiconductor was negligent regarding the design or manufacture of the part. ON Semiconductor is an Equal Opportunity/Affirmative Action Employer. This literature is subject to all applicable copyright laws and is not for resale in any manner.

FDC6333C

30V N & P-Channel PowerTrench[®] MOSFETs

General Description

These N & P-Channel MOSFETs are produced using Fairchild Semiconductor's advanced PowerTrench process that has been especially tailored to minimize on-state resistance and yet maintain superior switching performance.

These devices have been designed to offer exceptional power dissipation in a very small footprint for applications where the bigger more expensive SO-8 and TSSOP-8 packages are impractical.

Applications

- DC/DC converter
- Load switch
- LCD display inverter

Features

- **Q1** 2.5 A, 30V. $R_{DS(ON)} = 95 \text{ m}\Omega @ V_{GS} = 10 \text{ V}$
 $R_{DS(ON)} = 150 \text{ m}\Omega @ V_{GS} = 4.5 \text{ V}$
- **Q2** -2.0 A, 30V. $R_{DS(ON)} = 150 \text{ m}\Omega @ V_{GS} = -10 \text{ V}$
 $R_{DS(ON)} = 220 \text{ m}\Omega @ V_{GS} = -4.5 \text{ V}$
- Low gate charge
- High performance trench technology for extremely low $R_{DS(ON)}$.
- SuperSOT -6 package: small footprint (72% smaller than SO-8); low profile (1mm thick).

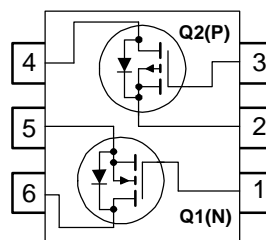
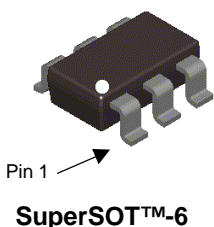

Absolute Maximum Ratings T_A=25°C unless otherwise noted

Symbol	Parameter	Q1	Q2	Units
V _{DSS}	Drain-Source Voltage	30	-30	V
V _{GSS}	Gate-Source Voltage	±16	±25	V
I _D	Drain Current – Continuous (Note 1a)	2.5	-2.0	A
	– Pulsed	8	-8	
P _D	Power Dissipation for Single Operation (Note 1a) (Note 1b) (Note 1c)	0.96		W
		0.9		
		0.7		
T _J , T _{STG}	Operating and Storage Junction Temperature Range	-55 to +150		°C

Thermal Characteristics

R _{θJA}	Thermal Resistance, Junction-to-Ambient (Note 1a)	130	°C/W
R _{θJC}	Thermal Resistance, Junction-to-Case (Note 1)	60	°C/W

Package Marking and Ordering Information

Device Marking	Device	Reel Size	Tape width	Quantity
.333	FDC6333C	7"	8mm	3000 units

Electrical Characteristics

T_A = 25°C unless otherwise noted

Symbol	Parameter	Test Conditions	Min	Typ	Max	Units
--------	-----------	-----------------	-----	-----	-----	-------

Off Characteristics

BV _{DSS}	Drain–Source Breakdown Voltage	V _{GS} = 0 V, I _D = 250 μA V _{GS} = 0 V, I _D = –250 μA	Q1 Q2	30 –30		V
$\frac{\Delta BV_{DSS}}{\Delta T_J}$	Breakdown Voltage Temperature Coefficient	I _D = 250 μA, Ref. to 25°C I _D = –250 μA, Ref. to 25°C	Q1 Q2		27 –22	mV/°C
I _{DSS}	Zero Gate Voltage Drain Current	V _{DS} = 24 V, V _{GS} = 0 V V _{DS} = –24 V, V _{GS} = 0 V	Q1 Q2		1 –1	μA
I _{GSSF}	Gate–Body Leakage, Forward	V _{GS} = 16 V, V _{DS} = 0 V V _{GS} = 25 V, V _{DS} = 0 V	Q1 Q2		100 100	nA
I _{GSSR}	Gate–Body Leakage, Reverse	V _{GS} = –16 V, V _{DS} = 0 V V _{GS} = –25 V, V _{DS} = 0 V	Q1 Q2		–100 –100	nA

On Characteristics (Note 2)

V _{GS(th)}	Gate Threshold Voltage	Q1	V _{DS} = V _{GS} , I _D = 250 μA	1	1.8	3	V
		Q2	V _{DS} = V _{GS} , I _D = –250 μA	–1	–1.8	–3	
$\frac{\Delta V_{GS(th)}}{\Delta T_J}$	Gate Threshold Voltage Temperature Coefficient	Q1	I _D = 250 μA, Ref. To 25°C		4		mV/°C
		Q2	I _D = –250 μA, Ref. to 25°C		–4		
R _{DS(on)}	Static Drain–Source On–Resistance	Q1	V _{GS} = 10 V, I _D = 2.5 A V _{GS} = 4.5 V, I _D = 2.0 A V _{GS} = 10 V, I _D = 2.5 A, T _J = 125°C		73 90 106	95 150 148	mΩ
		Q2	V _{GS} = –10 V, I _D = –2.0 A V _{GS} = –4.5 V, I _D = –1.7 A V _{GS} = 10 V, I _D = –2.0 A, T _J = 125°C		95 142 149	130 220 216	
I _{D(on)}	On–State Drain Current	Q1	V _{GS} = 10 V, V _{DS} = 5 V	8			A
		Q2	V _{GS} = –10 V, V _{DS} = –5 V	–8			
g _{FS}	Forward Transconductance	Q1	V _{DS} = 5 V, I _D = 2.5 A		7		S
		Q2	V _{DS} = –5 V, I _D = –2.0 A		3		

Dynamic Characteristics

C _{iss}	Input Capacitance	Q1	V _{DS} = 15 V, V _{GS} = 0 V, f = 1.0 MHz		282		pF
		Q2	V _{DS} = –15 V, V _{GS} = 0 V, f = 1.0 MHz		185		
C _{oss}	Output Capacitance	Q1	V _{DS} = 15 V, V _{GS} = 0 V, f = 1.0 MHz		49		pF
		Q2	V _{DS} = –15 V, V _{GS} = 0 V, f = 1.0 MHz		56		
C _{rss}	Reverse Transfer Capacitance	Q1	V _{DS} = 15 V, V _{GS} = 0 V, f = 1.0 MHz		20		pF
		Q2	V _{DS} = –15 V, V _{GS} = 0 V, f = 1.0 MHz		26		

Switching Characteristics (Note 2)

t _{d(on)}	Turn–On Delay Time	Q1	For Q1: V _{DS} = 15 V, I _{DS} = 1 A V _{GS} = 10 V, R _{GEN} = 6 Ω		4.5	9	ns
		Q2			4.5	9	
t _r	Turn–On Rise Time	Q1	For Q2: V _{DS} = –15 V, I _{DS} = –1 A V _{GS} = –10 V, R _{GEN} = 6 Ω		6	12	ns
		Q2			13	23	
t _{d(off)}	Turn–Off Delay Time	Q1	For Q1: V _{DS} = 15 V, I _{DS} = 2.5 A V _{GS} = 10 V, R _{GEN} = 6 Ω		19	34	ns
		Q2			11	20	
t _f	Turn–Off Fall Time	Q1	For Q2: V _{DS} = –15 V, I _{DS} = –2.0 A V _{GS} = –10 V, R _{GEN} = 6 Ω		1.5	3	ns
		Q2			2	4	
Q _g	Total Gate Charge	Q1	For Q1: V _{DS} = 15 V, I _{DS} = 2.5 A V _{GS} = 10 V, R _{GEN} = 6 Ω		4.7	6.6	nC
		Q2			4.1	5.7	
Q _{gs}	Gate–Source Charge	Q1	For Q2: V _{DS} = –15 V, I _{DS} = –2.0 A V _{GS} = –10 V, R _{GEN} = 6 Ω		0.9		nC
		Q2			0.8		
Q _{gd}	Gate–Drain Charge	Q1			0.6		nC
		Q2			0.4		

Electrical Characteristics

$T_A = 25^\circ\text{C}$ unless otherwise noted

Symbol	Parameter	Test Conditions	Min	Typ	Max	Units
--------	-----------	-----------------	-----	-----	-----	-------

Drain–Source Diode Characteristics and Maximum Ratings

I_S	Maximum Continuous Drain–Source Diode Forward Current	Q1			0.8	A	
		Q2			-0.8		
V_{SD}	Drain–Source Diode Forward Voltage	Q1	$V_{GS} = 0\text{ V}, I_S = 0.8\text{ A}$	(Note 2)	0.8	1.2	V
		Q2	$V_{GS} = 0\text{ V}, I_S = 0.8\text{ A}$	(Note 2)	0.8	-1.2	

Notes:

1. $R_{\theta JA}$ is the sum of the junction-to-case and case-to-ambient thermal resistance where the case thermal reference is defined as the solder mounting surface of the drain pins. $R_{\theta JC}$ is guaranteed by design while $R_{\theta CA}$ is determined by the user's board design.

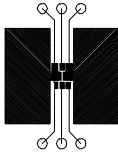

- a) 130°C/W when mounted on a 0.125 in^2 pad of 2 oz. copper.

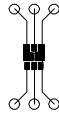

- b) 140°C/W when mounted on a $.004\text{ in}^2$ pad of 2 oz. copper

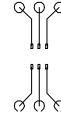

- c) 180°C/W when mounted on a minimum pad.

Scale 1 : 1 on letter size paper

2. Pulse Test: Pulse Width $< 300\mu\text{s}$, Duty Cycle $< 2.0\%$

Typical Characteristics: N-Channel

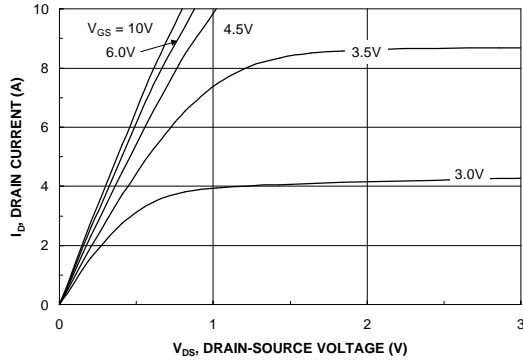

Figure 1. On-Region Characteristics.

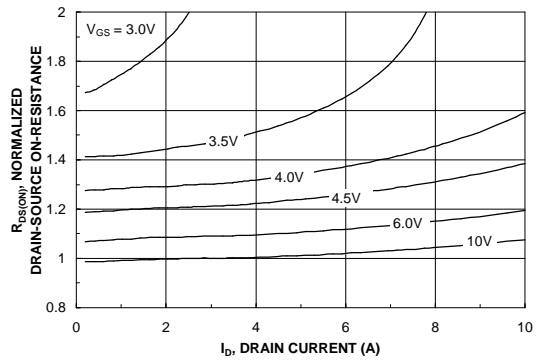

Figure 2. On-Resistance Variation with Drain Current and Gate Voltage.

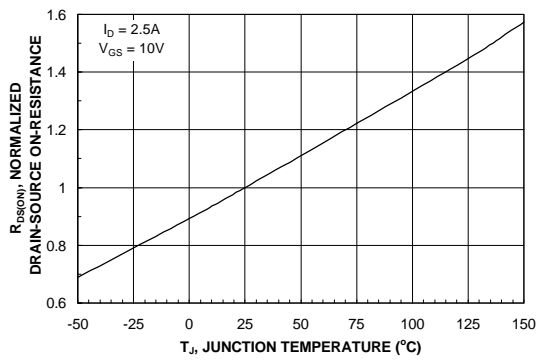

Figure 3. On-Resistance Variation with Temperature.

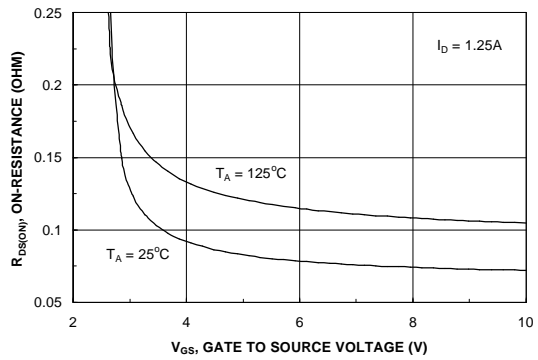

Figure 4. On-Resistance Variation with Gate-to-Source Voltage.

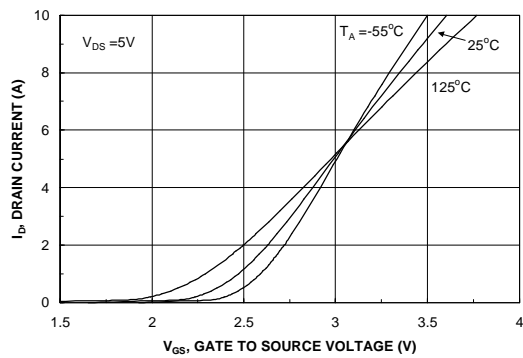

Figure 5. Transfer Characteristics.

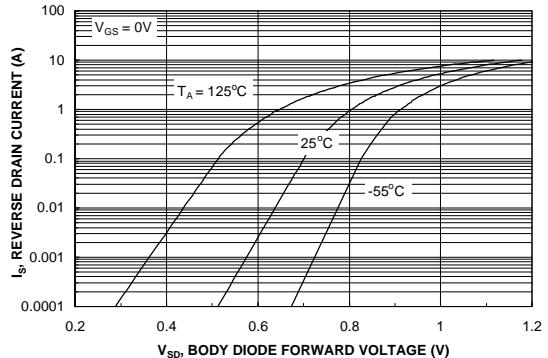

Figure 6. Body Diode Forward Voltage Variation with Source Current and Temperature.

Typical Characteristics: N-Channel (continued)

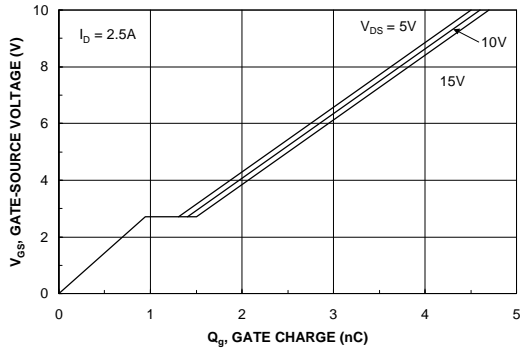

Figure 7. Gate Charge Characteristics.

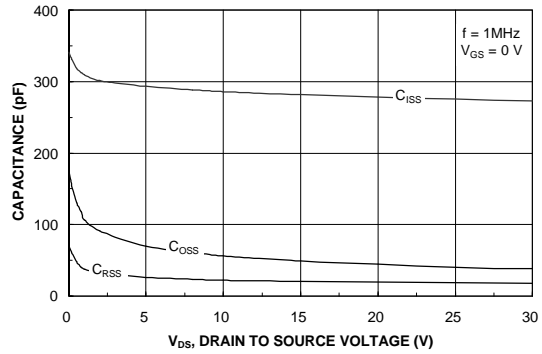

Figure 8. Capacitance Characteristics.

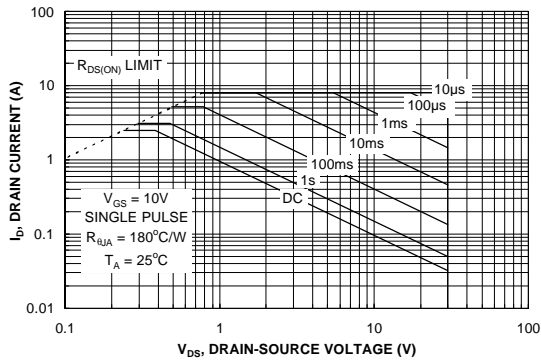

Figure 9. Maximum Safe Operating Area.

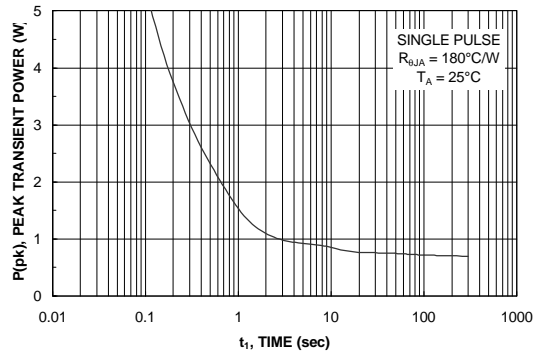

Figure 10. Single Pulse Maximum Power Dissipation.

Typical Characteristics: P-Channel

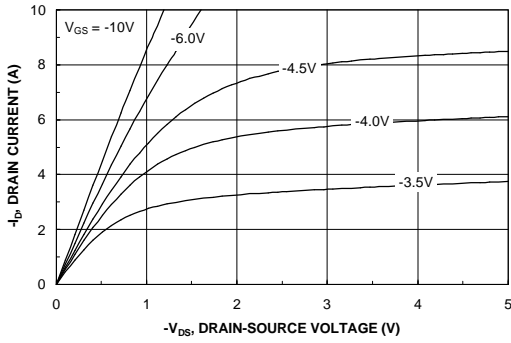

Figure 11. On-Region Characteristics.

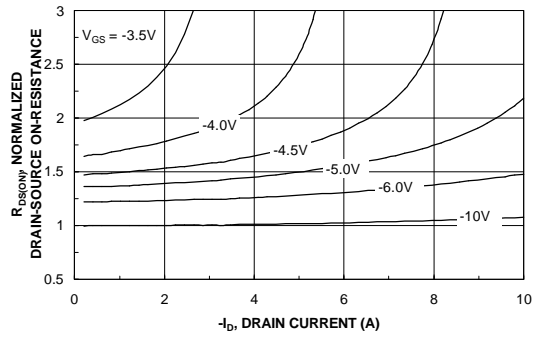

Figure 12. On-Resistance Variation with Drain Current and Gate Voltage.

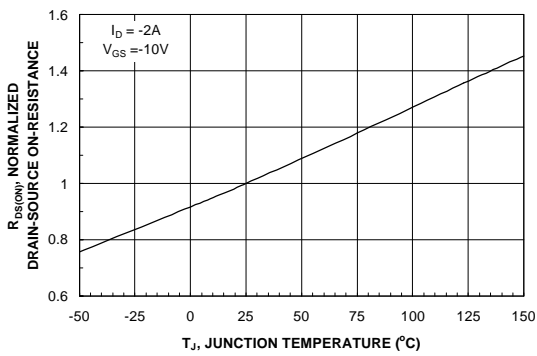

Figure 13. On-Resistance Variation with Temperature.

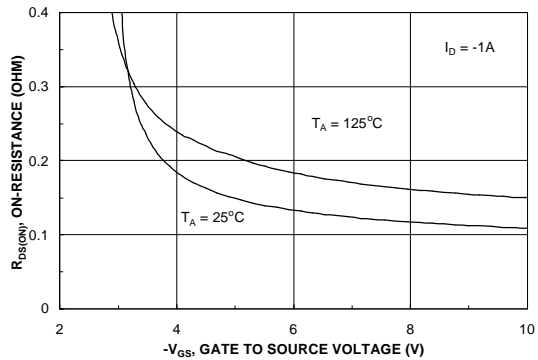

Figure 14. On-Resistance Variation with Gate-to-Source Voltage.

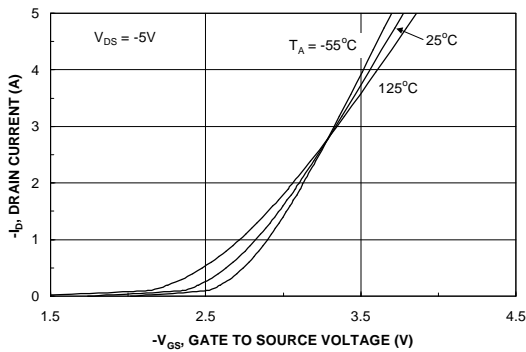

Figure 15. Transfer Characteristics.

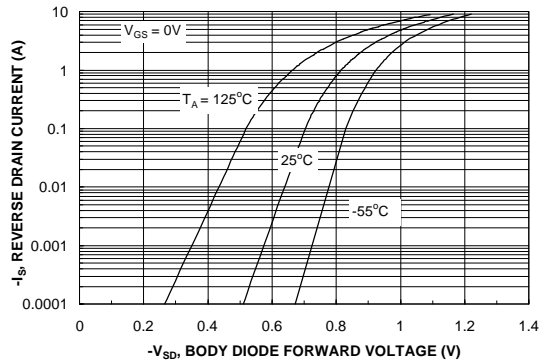

Figure 16. Body Diode Forward Voltage Variation with Source Current and Temperature.

Typical Characteristics: P-Channel (continued)

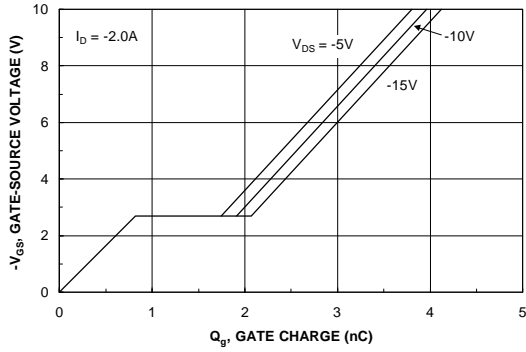

Figure 17. Gate Charge Characteristics.

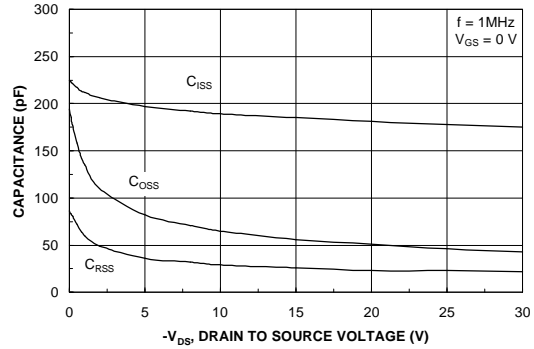

Figure 18. Capacitance Characteristics.

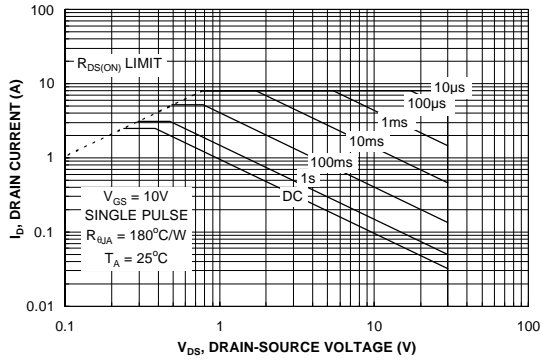

Figure 19. Maximum Safe Operating Area.

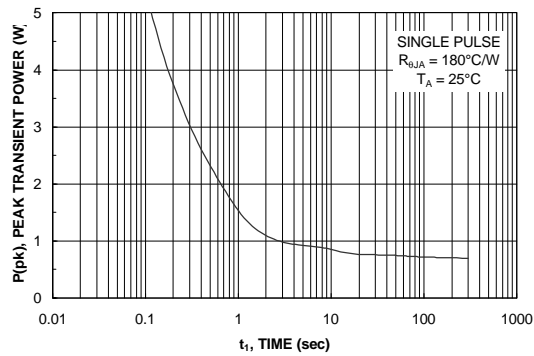

Figure 20. Single Pulse Maximum Power Dissipation.

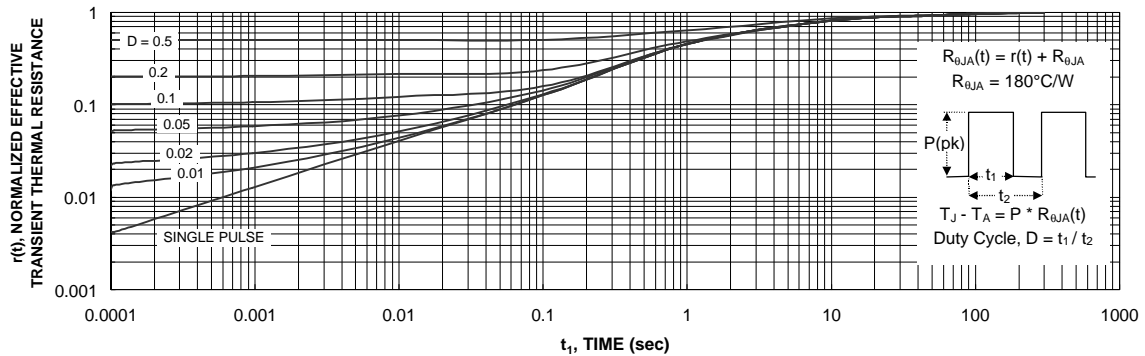

Figure 21. Transient Thermal Response Curve.

Thermal characterization performed using the conditions described in Note 1c.
Transient thermal response will change depending on the circuit board design.

TRADEMARKS

The following are registered and unregistered trademarks Fairchild Semiconductor owns or is authorized to use and is not intended to be an exhaustive list of all such trademarks.

ACE _x TM	FAST [®]	OPTOLOGIC TM	SMART START TM	VCX TM
Bottomless TM	FAST _r TM	OPTOPLANAR TM	STAR*POWER TM	
CoolFET TM	FRFET TM	PACMAN TM	Stealth TM	
CROSSVOLT TM	GlobalOptoisolator TM	POPT TM	SuperSOT TM -3	
DenseTrench TM	GTO TM	Power247 TM	SuperSOT TM -6	
DOMET TM	HiSeC TM	PowerTrench [®]	SuperSOT TM -8	
EcoSPARK TM	ISOPLANAR TM	QFET TM	SyncFET TM	
E ² CMOS TM	LittleFET TM	QST TM	TinyLogic TM	
EnSigna TM	MicroFET TM	QT Optoelectronics TM	TruTranslation TM	
FACT TM	MicroPak TM	Quiet Series TM	UHC TM	
FACT Quiet Series TM	MICROWIRE TM	SILENT SWITCHER [®]	UltraFET [®]	

STAR*POWER is used under license

DISCLAIMER

FAIRCHILD SEMICONDUCTOR RESERVES THE RIGHT TO MAKE CHANGES WITHOUT FURTHER NOTICE TO ANY PRODUCTS HEREIN TO IMPROVE RELIABILITY, FUNCTION OR DESIGN. FAIRCHILD DOES NOT ASSUME ANY LIABILITY ARISING OUT OF THE APPLICATION OR USE OF ANY PRODUCT OR CIRCUIT DESCRIBED HEREIN; NEITHER DOES IT CONVEY ANY LICENSE UNDER ITS PATENT RIGHTS, NOR THE RIGHTS OF OTHERS.

LIFE SUPPORT POLICY

FAIRCHILD'S PRODUCTS ARE NOT AUTHORIZED FOR USE AS CRITICAL COMPONENTS IN LIFE SUPPORT DEVICES OR SYSTEMS WITHOUT THE EXPRESS WRITTEN APPROVAL OF FAIRCHILD SEMICONDUCTOR CORPORATION.

As used herein:

1. Life support devices or systems are devices or systems which, (a) are intended for surgical implant into the body, or (b) support or sustain life, or (c) whose failure to perform when properly used in accordance with instructions for use provided in the labeling, can be reasonably expected to result in significant injury to the user.
2. A critical component is any component of a life support device or system whose failure to perform can be reasonably expected to cause the failure of the life support device or system, or to affect its safety or effectiveness.

PRODUCT STATUS DEFINITIONS

Definition of Terms

Datasheet Identification	Product Status	Definition
Advance Information	Formative or In Design	This datasheet contains the design specifications for product development. Specifications may change in any manner without notice.
Preliminary	First Production	This datasheet contains preliminary data, and supplementary data will be published at a later date. Fairchild Semiconductor reserves the right to make changes at any time without notice in order to improve design.
No Identification Needed	Full Production	This datasheet contains final specifications. Fairchild Semiconductor reserves the right to make changes at any time without notice in order to improve design.
Obsolete	Not In Production	This datasheet contains specifications on a product that has been discontinued by Fairchild semiconductor. The datasheet is printed for reference information only.

ON Semiconductor and  are trademarks of Semiconductor Components Industries, LLC dba ON Semiconductor or its subsidiaries in the United States and/or other countries. ON Semiconductor owns the rights to a number of patents, trademarks, copyrights, trade secrets, and other intellectual property. A listing of ON Semiconductor's product/patent coverage may be accessed at www.onsemi.com/site/pdf/Patent-Marking.pdf. ON Semiconductor reserves the right to make changes without further notice to any products herein. ON Semiconductor makes no warranty, representation or guarantee regarding the suitability of its products for any particular purpose, nor does ON Semiconductor assume any liability arising out of the application or use of any product or circuit, and specifically disclaims any and all liability, including without limitation special, consequential or incidental damages. Buyer is responsible for its products and applications using ON Semiconductor products, including compliance with all laws, regulations and safety requirements or standards, regardless of any support or applications information provided by ON Semiconductor. "Typical" parameters which may be provided in ON Semiconductor data sheets and/or specifications can and do vary in different applications and actual performance may vary over time. All operating parameters, including "Typicals" must be validated for each customer application by customer's technical experts. ON Semiconductor does not convey any license under its patent rights nor the rights of others. ON Semiconductor products are not designed, intended, or authorized for use as a critical component in life support systems or any FDA Class 3 medical devices or medical devices with a same or similar classification in a foreign jurisdiction or any devices intended for implantation in the human body. Should Buyer purchase or use ON Semiconductor products for any such unintended or unauthorized application, Buyer shall indemnify and hold ON Semiconductor and its officers, employees, subsidiaries, affiliates, and distributors harmless against all claims, costs, damages, and expenses, and reasonable attorney fees arising out of, directly or indirectly, any claim of personal injury or death associated with such unintended or unauthorized use, even if such claim alleges that ON Semiconductor was negligent regarding the design or manufacture of the part. ON Semiconductor is an Equal Opportunity/Affirmative Action Employer. This literature is subject to all applicable copyright laws and is not for resale in any manner.

PUBLICATION ORDERING INFORMATION

LITERATURE FULFILLMENT:

Literature Distribution Center for ON Semiconductor
19521 E. 32nd Pkwy, Aurora, Colorado 80011 USA
Phone: 303-675-2175 or 800-344-3860 Toll Free USA/Canada
Fax: 303-675-2176 or 800-344-3867 Toll Free USA/Canada
Email: orderlit@onsemi.com

N. American Technical Support: 800-282-9855 Toll Free
USA/Canada
Europe, Middle East and Africa Technical Support:
Phone: 421 33 790 2910
Japan Customer Focus Center
Phone: 81-3-5817-1050

ON Semiconductor Website: www.onsemi.com
Order Literature: <http://www.onsemi.com/orderlit>
For additional information, please contact your local
Sales Representative