



Is Now Part of



ON Semiconductor®

To learn more about ON Semiconductor, please visit our website at
www.onsemi.com

ON Semiconductor and the ON Semiconductor logo are trademarks of Semiconductor Components Industries, LLC dba ON Semiconductor or its subsidiaries in the United States and/or other countries. ON Semiconductor owns the rights to a number of patents, trademarks, copyrights, trade secrets, and other intellectual property. A listing of ON Semiconductor's product/patent coverage may be accessed at www.onsemi.com/site/pdf/Patent-Marking.pdf. ON Semiconductor reserves the right to make changes without further notice to any products herein. ON Semiconductor makes no warranty, representation or guarantee regarding the suitability of its products for any particular purpose, nor does ON Semiconductor assume any liability arising out of the application or use of any product or circuit, and specifically disclaims any and all liability, including without limitation special, consequential or incidental damages. Buyer is responsible for its products and applications using ON Semiconductor products, including compliance with all laws, regulations and safety requirements or standards, regardless of any support or applications information provided by ON Semiconductor. "Typical" parameters which may be provided in ON Semiconductor data sheets and/or specifications can and do vary in different applications and actual performance may vary over time. All operating parameters, including "Typicals" must be validated for each customer application by customer's technical experts. ON Semiconductor does not convey any license under its patent rights nor the rights of others. ON Semiconductor products are not designed, intended, or authorized for use as a critical component in life support systems or any FDA Class 3 medical devices or medical devices with a same or similar classification in a foreign jurisdiction or any devices intended for implantation in the human body. Should Buyer purchase or use ON Semiconductor products for any such unintended or unauthorized application, Buyer shall indemnify and hold ON Semiconductor and its officers, employees, subsidiaries, affiliates, and distributors harmless against all claims, costs, damages, and expenses, and reasonable attorney fees arising out of, directly or indirectly, any claim of personal injury or death associated with such unintended or unauthorized use, even if such claim alleges that ON Semiconductor was negligent regarding the design or manufacture of the part. ON Semiconductor is an Equal Opportunity/Affirmative Action Employer. This literature is subject to all applicable copyright laws and is not for resale in any manner.

FCB36N60N

N-Channel SupreMOS® MOSFET

600 V, 36 A, 90 mΩ



Features

- $R_{DS(on)} = 81 \text{ m}\Omega$ (Typ.) @ $V_{GS} = 10 \text{ V}$, $I_D = 18 \text{ A}$
- Ultra Low Gate Charge (Typ. $Q_g = 86 \text{ nC}$)
- Low Effective Output Capacitance (Typ. $C_{oss(eff.)} = 361 \text{ pF}$)
- 100% Avalanche Tested
- RoHS Compliant

Description

The SupreMOS® MOSFET is Fairchild Semiconductor's next generation of high voltage super-junction (SJ) technology employing a deep trench filling process that differentiates it from the conventional SJ MOSFETs. This advanced technology and precise process control provides lowest R_{sp} on-resistance, superior switching performance and ruggedness. SupreMOS MOSFET is suitable for high frequency switching power converter applications such as PFC, server/telecom power, FPD TV power, ATX power, and industrial power applications.

Applications

- Solar Inverter
- AC-DC Power Supply

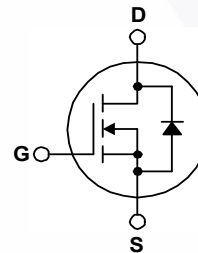
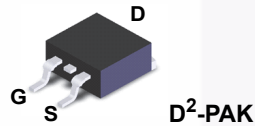

MOSFET Maximum Ratings $T_C = 25^\circ\text{C}$ unless otherwise noted.

| Symbol | Parameter | FCB36N60N | Unit |
|----------------|--|--|------------------|
| V_{DSS} | Drain to Source Voltage | 600 | V |
| V_{GSS} | Gate to Source Voltage | ± 30 | V |
| I_D | Drain Current | - Continuous ($T_C = 25^\circ\text{C}$) | 36 |
| | | - Continuous ($T_C = 100^\circ\text{C}$) | 22.7 |
| I_{DM} | Drain Current | - Pulsed (Note 1) | 108 |
| E_{AS} | Single Pulsed Avalanche Energy | (Note 2) | 1800 |
| I_{AR} | Avalanche Current | (Note 1) | 12 |
| E_{AR} | Repetitive Avalanche Energy | (Note 1) | 3.12 |
| dv/dt | MOSFET dv/dt | | 100 |
| | Peak Diode Recovery dv/dt | (Note 3) | 20 |
| P_D | Power Dissipation | ($T_C = 25^\circ\text{C}$) | 312 |
| | | - Derate Above 25°C | 2.6 |
| T_J, T_{STG} | Operating and Storage Temperature Range | -55 to +150 | $^\circ\text{C}$ |
| T_L | Maximum Lead Temperature for Soldering, 1/8" from Case for 5 Seconds | 300 | $^\circ\text{C}$ |

Thermal Characteristics

| Symbol | Parameter | FCB36N60N | Unit |
|-----------------|--|-----------|---------------------------|
| $R_{\theta JC}$ | Thermal Resistance, Junction to Case, Max. | 0.4 | $^\circ\text{C}/\text{W}$ |
| $R_{\theta JA}$ | Thermal Resistance, Junction to Ambient (1 in ² Pad of 2-oz Copper), Max. | 40 | |
| $R_{\theta JA}$ | Thermal Resistance, Junction to Ambient (Minimum Pad of 2-oz Copper), Max. | 62.5 | |

Package Marking and Ordering Information

| Part Number | Top Mark | Package | Packing Method | Reel Size | Tape Width | Quantity |
|-------------|-----------|---------------------|----------------|-----------|------------|-----------|
| FCB36N60N | FCB36N60N | D ² -PAK | Tape and Reel | 330 mm | 24 mm | 800 units |

Electrical Characteristics $T_C = 25^\circ\text{C}$ unless otherwise noted.

| Symbol | Parameter | Test Conditions | Min. | Typ. | Max. | Unit |
|--------|-----------|-----------------|------|------|------|------|
|--------|-----------|-----------------|------|------|------|------|

Off Characteristics

| | | | | | | |
|--------------------------------|---|---|-----|-----|-----------|---------------------|
| BV_{DSS} | Drain to Source Breakdown Voltage | $I_D = 1 \text{ mA}, V_{GS} = 0 \text{ V}, T_C = 25^\circ\text{C}$ | 600 | - | - | V |
| $\Delta BV_{DSS} / \Delta T_J$ | Breakdown Voltage Temperature Coefficient | $I_D = 1 \text{ mA}, \text{Referenced to } 25^\circ\text{C}$ | - | 0.7 | - | V/ $^\circ\text{C}$ |
| I_{DSS} | Zero Gate Voltage Drain Current | $V_{DS} = 480 \text{ V}, V_{GS} = 0 \text{ V}$ | - | - | 10 | μA |
| | | $V_{DS} = 480 \text{ V}, V_{GS} = 0 \text{ V}, T_C = 125^\circ\text{C}$ | - | - | 100 | μA |
| I_{GSS} | Gate to Body Leakage Current | $V_{GS} = \pm 30 \text{ V}, V_{DS} = 0 \text{ V}$ | - | - | ± 100 | nA |

On Characteristics

| | | | | | | |
|--------------|--------------------------------------|---|-----|----|-----|------------|
| $V_{GS(th)}$ | Gate Threshold Voltage | $V_{GS} = V_{DS}, I_D = 250 \mu\text{A}$ | 2.0 | - | 4.0 | V |
| $R_{DS(on)}$ | Static Drain to Source On Resistance | $V_{GS} = 10 \text{ V}, I_D = 18 \text{ A}$ | - | 81 | 90 | m Ω |
| g_{FS} | Forward Transconductance | $V_{DS} = 40 \text{ V}, I_D = 18 \text{ A}$ | - | 41 | - | S |

Dynamic Characteristics

| | | | | | | |
|-----------------|------------------------------------|---|---|------|------|----------|
| C_{iss} | Input Capacitance | $V_{DS} = 100 \text{ V}, V_{GS} = 0 \text{ V}, f = 1 \text{ MHz}$ | - | 3595 | 4785 | pF |
| C_{oss} | Output Capacitance | | - | 149 | 200 | pF |
| C_{rss} | Reverse Transfer Capacitance | | - | 4 | 6 | pF |
| C_{oss} | Output Capacitance | $V_{DS} = 380 \text{ V}, V_{GS} = 0 \text{ V}, f = 1 \text{ MHz}$ | - | 80 | - | pF |
| $C_{oss(eff.)}$ | Effective Output Capacitance | $V_{DS} = 0 \text{ V to } 380 \text{ V}, V_{GS} = 0 \text{ V}$ | - | 361 | - | pF |
| $Q_{g(tot)}$ | Total Gate Charge at 10V | $V_{DS} = 380 \text{ V}, I_D = 18 \text{ A}, V_{GS} = 10 \text{ V}$ (Note 4) | - | 86 | 112 | nC |
| Q_{gs} | Gate to Source Gate Charge | | - | 15.4 | - | nC |
| Q_{gd} | Gate to Drain "Miller" Charge | | - | 26.4 | - | nC |
| ESR | Equivalent Series Resistance (G-S) | $f = 1 \text{ MHz}$ | - | 1 | - | Ω |

Switching Characteristics

| | | | | | | |
|--------------|---------------------|---|---|----|-----|----|
| $t_{d(on)}$ | Turn-On Delay Time | $V_{DD} = 380 \text{ V}, I_D = 18 \text{ A}, V_{GS} = 10 \text{ V}, R_G = 4.7 \Omega$ (Note 4) | - | 23 | 56 | ns |
| t_r | Turn-On Rise Time | | - | 22 | 54 | ns |
| $t_{d(off)}$ | Turn-Off Delay Time | | - | 94 | 198 | ns |
| t_f | Turn-Off Fall Time | | - | 4 | 18 | ns |

Drain-Source Diode Characteristics

| | | | | | | |
|----------|--|--|---|-----|-----|---------------|
| I_S | Maximum Continuous Drain to Source Diode Forward Current | - | - | 36 | A | |
| I_{SM} | Maximum Pulsed Drain to Source Diode Forward Current | - | - | 108 | A | |
| V_{SD} | Drain to Source Diode Forward Voltage | $V_{GS} = 0 \text{ V}, I_{SD} = 18 \text{ A}$ | - | - | 1.2 | V |
| t_{rr} | Reverse Recovery Time | $V_{GS} = 0 \text{ V}, I_{SD} = 18 \text{ A}, di_F/dt = 100 \text{ A}/\mu\text{s}$ | - | 574 | - | ns |
| Q_{rr} | Reverse Recovery Charge | | - | 10 | - | μC |

Notes:

1. Repetitive rating; pulse-width limited by maximum junction temperature.
2. $I_{AS} = 12 \text{ A}, R_G = 25 \Omega$, starting $T_J = 25^\circ\text{C}$.
3. $I_{SD} \leq 36 \text{ A}, di/dt \leq 200 \text{ A}/\mu\text{s}, V_{DD} = 380 \text{ V}$, starting $T_J = 25^\circ\text{C}$.
4. Essentially independent of operating temperature typical characteristics.

Typical Performance Characteristics

Figure 1. On-Region Characteristics

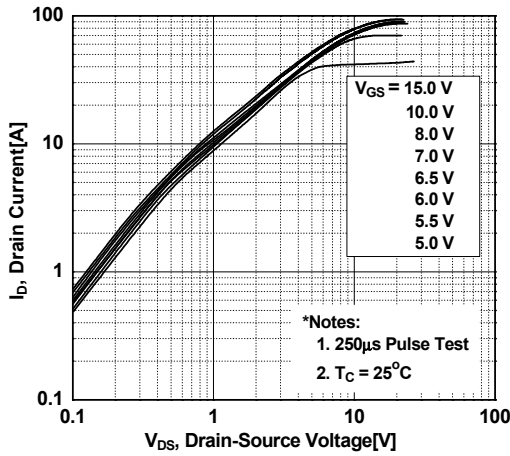

Figure 2. Transfer Characteristics

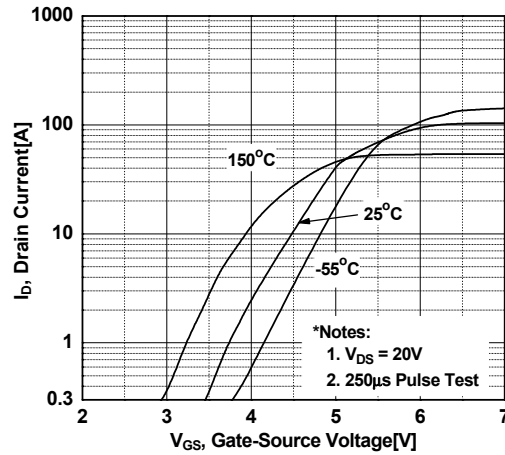

Figure 3. On-Resistance Variation vs. Drain Current and Gate Voltage

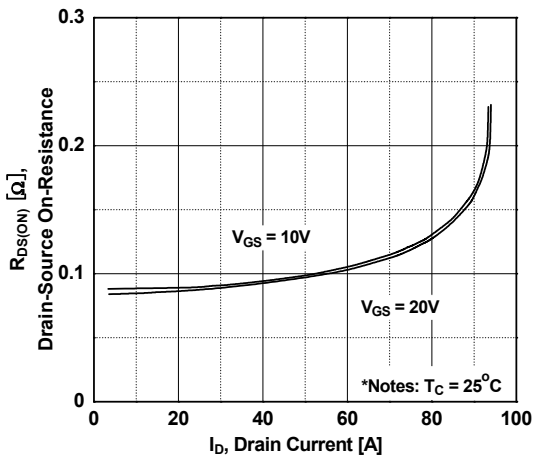

Figure 4. Body Diode Forward Voltage Variation vs. Source Current and Temperature

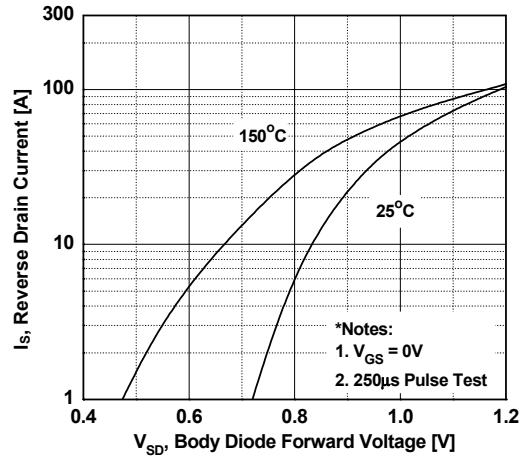

Figure 5. Capacitance Characteristics

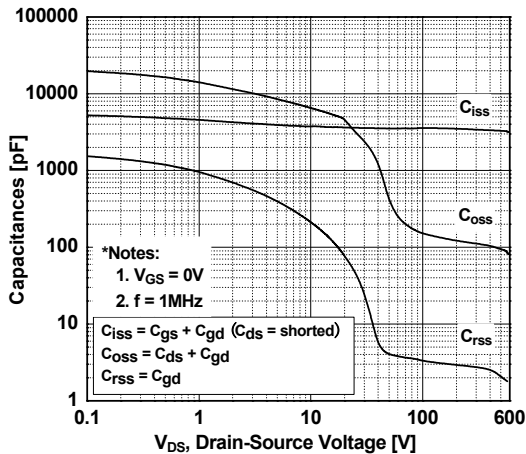
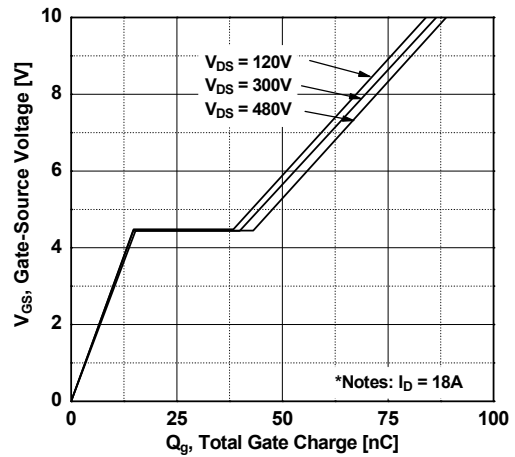

Figure 6. Gate Charge Characteristics



Typical Performance Characteristics (Continued)

Figure 7. Breakdown Voltage Variation vs. Temperature

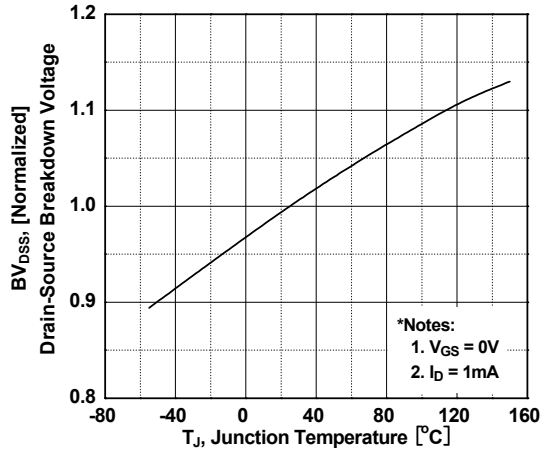

Figure 8. On-Resistance Variation vs. Temperature

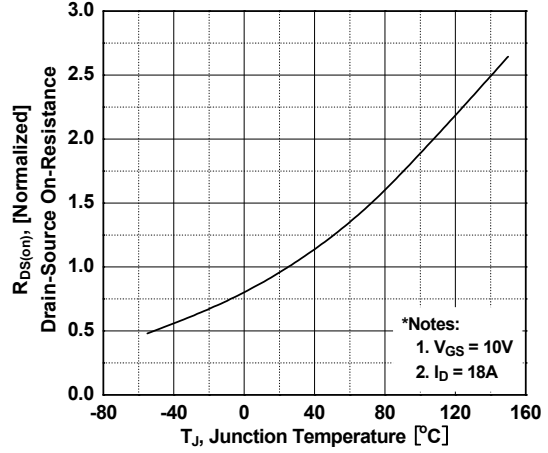

Figure 9. Maximum Safe Operating Area

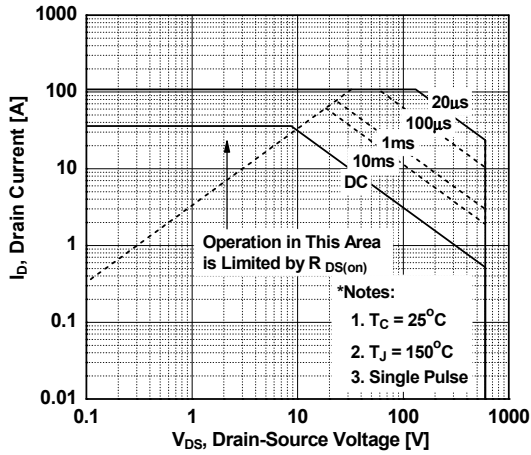

Figure 10. Maximum Drain Current vs. Case Temperature

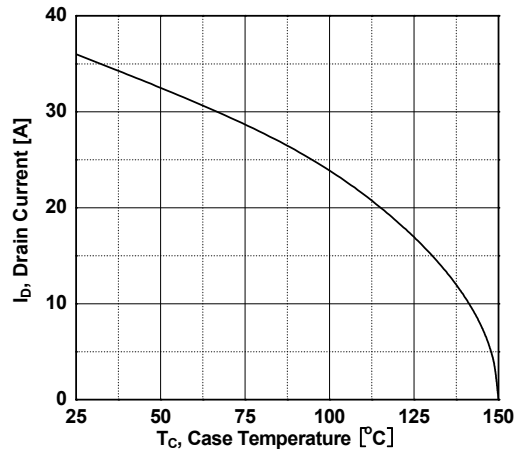
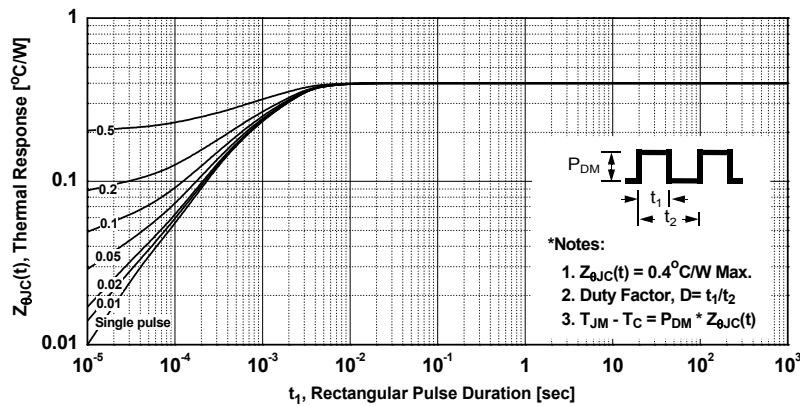

Figure 11. Transient Thermal Response Curve



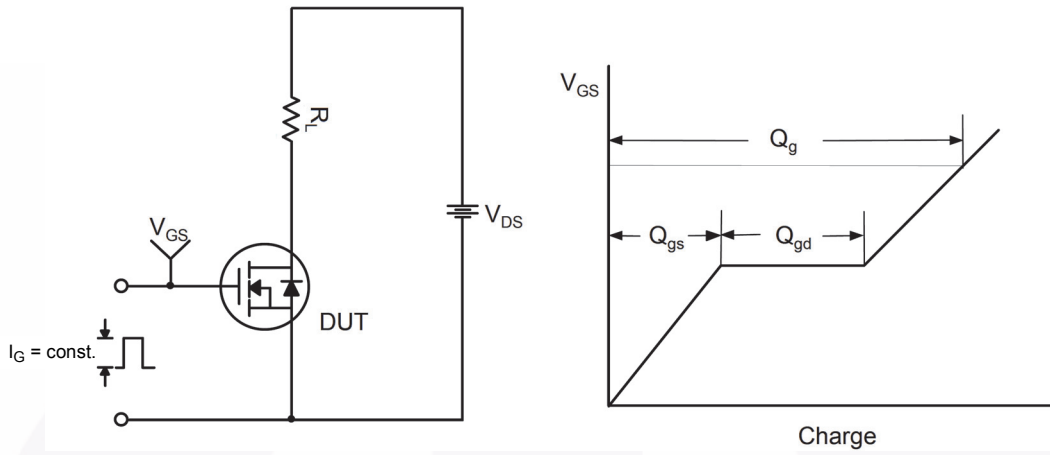

Figure 12. Gate Charge Test Circuit & Waveform



Figure 13. Resistive Switching Test Circuit & Waveforms



Figure 14. Unclamped Inductive Switching Test Circuit & Waveforms



Figure 15. Peak Diode Recovery dv/dt Test Circuit & Waveforms

Mechanical Dimensions

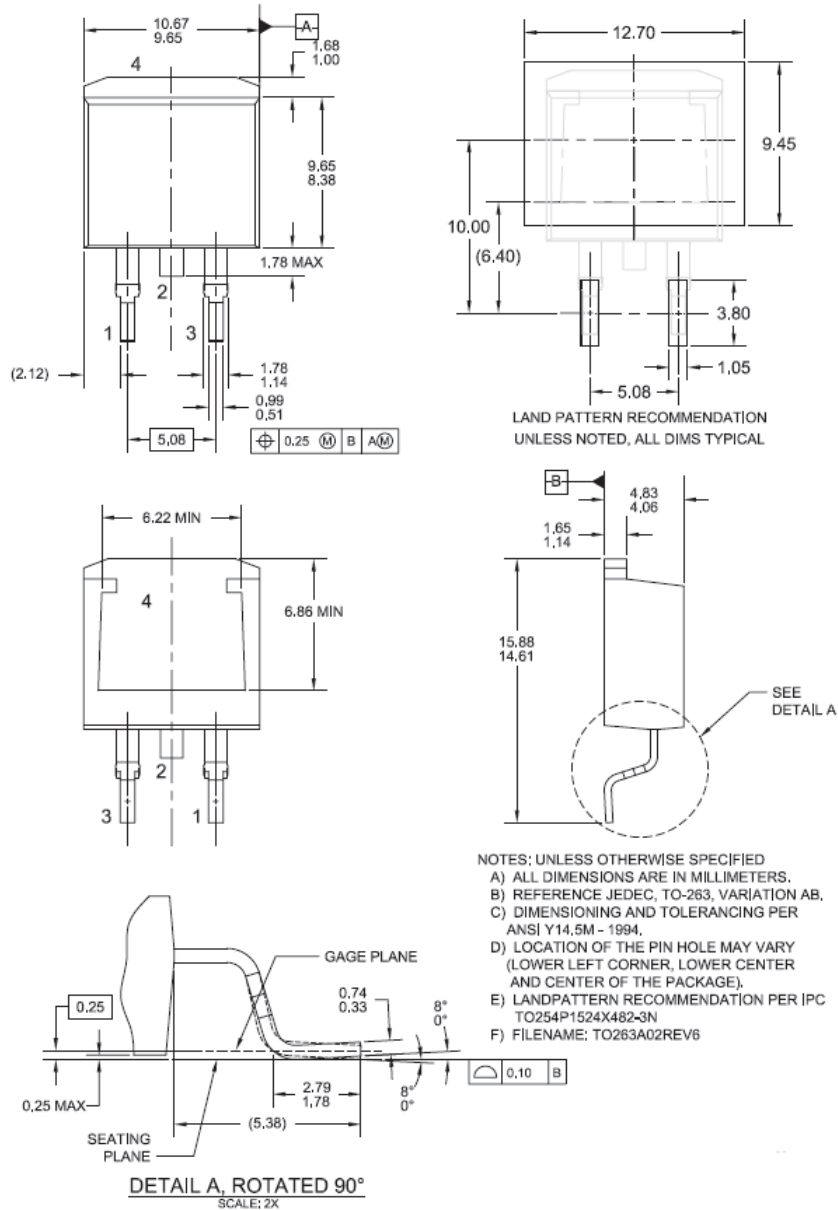

Figure 16. TO263 (D²PAK), Molded, 2-Lead, Surface Mount

Package drawings are provided as a service to customers considering Fairchild components. Drawings may change in any manner without notice. Please note the revision and/or date on the drawing and contact a Fairchild Semiconductor representative to verify or obtain the most recent revision. Package specifications do not expand the terms of Fairchild's worldwide terms and conditions, specifically the warranty therein, which covers Fairchild products.

Always visit Fairchild Semiconductor's online packaging area for the most recent package drawings:

http://www.fairchildsemi.com/package/packageDetails.html?id=PN_TT263-0R2

ON Semiconductor and  are trademarks of Semiconductor Components Industries, LLC dba ON Semiconductor or its subsidiaries in the United States and/or other countries. ON Semiconductor owns the rights to a number of patents, trademarks, copyrights, trade secrets, and other intellectual property. A listing of ON Semiconductor's product/patent coverage may be accessed at www.onsemi.com/site/pdf/Patent-Marking.pdf. ON Semiconductor reserves the right to make changes without further notice to any products herein. ON Semiconductor makes no warranty, representation or guarantee regarding the suitability of its products for any particular purpose, nor does ON Semiconductor assume any liability arising out of the application or use of any product or circuit, and specifically disclaims any and all liability, including without limitation special, consequential or incidental damages. Buyer is responsible for its products and applications using ON Semiconductor products, including compliance with all laws, regulations and safety requirements or standards, regardless of any support or applications information provided by ON Semiconductor. "Typical" parameters which may be provided in ON Semiconductor data sheets and/or specifications can and do vary in different applications and actual performance may vary over time. All operating parameters, including "Typicals" must be validated for each customer application by customer's technical experts. ON Semiconductor does not convey any license under its patent rights nor the rights of others. ON Semiconductor products are not designed, intended, or authorized for use as a critical component in life support systems or any FDA Class 3 medical devices or medical devices with a same or similar classification in a foreign jurisdiction or any devices intended for implantation in the human body. Should Buyer purchase or use ON Semiconductor products for any such unintended or unauthorized application, Buyer shall indemnify and hold ON Semiconductor and its officers, employees, subsidiaries, affiliates, and distributors harmless against all claims, costs, damages, and expenses, and reasonable attorney fees arising out of, directly or indirectly, any claim of personal injury or death associated with such unintended or unauthorized use, even if such claim alleges that ON Semiconductor was negligent regarding the design or manufacture of the part. ON Semiconductor is an Equal Opportunity/Affirmative Action Employer. This literature is subject to all applicable copyright laws and is not for resale in any manner.

PUBLICATION ORDERING INFORMATION

LITERATURE FULFILLMENT:

Literature Distribution Center for ON Semiconductor
19521 E. 32nd Pkwy, Aurora, Colorado 80011 USA
Phone: 303-675-2175 or 800-344-3860 Toll Free USA/Canada
Fax: 303-675-2176 or 800-344-3867 Toll Free USA/Canada
Email: orderlit@onsemi.com

N. American Technical Support: 800-282-9855 Toll Free
USA/Canada
Europe, Middle East and Africa Technical Support:
Phone: 421 33 790 2910
Japan Customer Focus Center
Phone: 81-3-5817-1050

ON Semiconductor Website: www.onsemi.com
Order Literature: <http://www.onsemi.com/orderlit>
For additional information, please contact your local
Sales Representative