



Is Now Part of



ON Semiconductor®

To learn more about ON Semiconductor, please visit our website at
www.onsemi.com

ON Semiconductor and the ON Semiconductor logo are trademarks of Semiconductor Components Industries, LLC dba ON Semiconductor or its subsidiaries in the United States and/or other countries. ON Semiconductor owns the rights to a number of patents, trademarks, copyrights, trade secrets, and other intellectual property. A listing of ON Semiconductor's product/patent coverage may be accessed at www.onsemi.com/site/pdf/Patent-Marking.pdf. ON Semiconductor reserves the right to make changes without further notice to any products herein. ON Semiconductor makes no warranty, representation or guarantee regarding the suitability of its products for any particular purpose, nor does ON Semiconductor assume any liability arising out of the application or use of any product or circuit, and specifically disclaims any and all liability, including without limitation special, consequential or incidental damages. Buyer is responsible for its products and applications using ON Semiconductor products, including compliance with all laws, regulations and safety requirements or standards, regardless of any support or applications information provided by ON Semiconductor. "Typical" parameters which may be provided in ON Semiconductor data sheets and/or specifications can and do vary in different applications and actual performance may vary over time. All operating parameters, including "Typicals" must be validated for each customer application by customer's technical experts. ON Semiconductor does not convey any license under its patent rights nor the rights of others. ON Semiconductor products are not designed, intended, or authorized for use as a critical component in life support systems or any FDA Class 3 medical devices or medical devices with a same or similar classification in a foreign jurisdiction or any devices intended for implantation in the human body. Should Buyer purchase or use ON Semiconductor products for any such unintended or unauthorized application, Buyer shall indemnify and hold ON Semiconductor and its officers, employees, subsidiaries, affiliates, and distributors harmless against all claims, costs, damages, and expenses, and reasonable attorney fees arising out of, directly or indirectly, any claim of personal injury or death associated with such unintended or unauthorized use, even if such claim alleges that ON Semiconductor was negligent regarding the design or manufacture of the part. ON Semiconductor is an Equal Opportunity/Affirmative Action Employer. This literature is subject to all applicable copyright laws and is not for resale in any manner.

BCV26

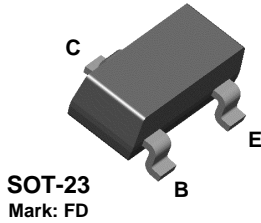

PNP Darlington Transistor

This device is designed for applications requiring extremely high current gain at currents to 800 mA. Sourced from Process 61.

Absolute Maximum Ratings*

TA = 25°C unless otherwise noted

| Symbol | Parameter | Value | Units |
|----------------|--|-------------|-------|
| V_{CEO} | Collector-Emitter Voltage | 30 | V |
| V_{CBO} | Collector-Base Voltage | 40 | V |
| V_{EBO} | Emitter-Base Voltage | 10 | V |
| I_C | Collector Current - Continuous | 1.2 | A |
| T_J, T_{stg} | Operating and Storage Junction Temperature Range | -55 to +150 | °C |

*These ratings are limiting values above which the serviceability of any semiconductor device may be impaired.

NOTES:

- 1) These ratings are based on a maximum junction temperature of 150 degrees C.
- 2) These are steady state limits. The factory should be consulted on applications involving pulsed or low duty cycle operations.
- 3) All voltages (V) and currents (A) are negative polarity for PNP transistors.

Thermal Characteristics

TA = 25°C unless otherwise noted

| Symbol | Characteristic | Max | Units |
|-----------------|---|--------|-------|
| | | *BCV26 | |
| P_D | Total Device Dissipation Derate above 25°C | 350 | mW |
| | | 2.8 | mW/°C |
| $R_{\theta JA}$ | Thermal Resistance, Junction to Ambient | 357 | °C/W |

*Device mounted on FR-4 PCB 40 mm X 40 mm X 1.5 mm.

PNP Darlington Transistor

(continued)

BCV26

Electrical Characteristics TA = 25°C unless otherwise noted

| Symbol | Parameter | Test Conditions | Min | Typ | Max | Units |
|----------------------------|-------------------------------------|---|-----|-----|-----|---------------|
| OFF CHARACTERISTICS | | | | | | |
| $V_{(BR)CEO}$ | Collector-Emitter Breakdown Voltage | $I_C = 10 \text{ mA}, I_B = 0$ | 30 | | | V |
| $V_{(BR)CBO}$ | Collector-Base Breakdown Voltage | $I_C = 10 \text{ }\mu\text{A}, I_E = 0$ | 40 | | | V |
| $V_{(BR)EBO}$ | Emitter-Base Breakdown Voltage | $I_E = 100 \text{ nA}, I_C = 0$ | 10 | | | V |
| I_{CBO} | Collector-Cutoff Current | $V_{CB} = 30 \text{ V}, I_E = 0$ | | | 0.1 | μA |
| I_{EBO} | Emitter-Cutoff Current | $V_{EB} = 10 \text{ V}, I_C = 0$ | | | 0.1 | μA |

ON CHARACTERISTICS

| | | | | | | |
|---------------|--------------------------------------|---|---------------------------|--|-----|---|
| h_{FE} | DC Current Gain | $I_C = 1.0 \text{ mA}, V_{CE} = 5.0 \text{ V}$ $I_C = 10 \text{ mA}, V_{CE} = 5.0 \text{ V}$ $I_C = 100 \text{ mA}, V_{CE} = 5.0 \text{ V}$ | 4,000 10,000 20,000 | | | |
| $V_{CE(sat)}$ | Collector-Emitter Saturation Voltage | $I_C = 100 \text{ mA}, I_B = 0.1 \text{ mA}$ | | | 1.0 | V |
| $V_{BE(sat)}$ | Base-Emitter Saturation Voltage | $I_C = 100 \text{ mA}, I_B = 0.1 \text{ mA}$ | | | 1.5 | V |

SMALL SIGNAL CHARACTERISTICS

| | | | | | | |
|-------|----------------------------------|---|--|-----|--|-----|
| f_T | Current Gain - Bandwidth Product | $I_C = 30 \text{ mA}, V_{CE} = 5.0 \text{ V},$ $f = 100 \text{ MHz}$ | | 220 | | MHz |
| C_C | Collector Capacitance | $V_{CB} = 30 \text{ V}, I_E = 0, f = 1.0 \text{ MHz}$ | | 3.5 | | pF |

NOTE: All voltages (V) and currents (A) are negative polarity for PNP transistors.

Typical Characteristics

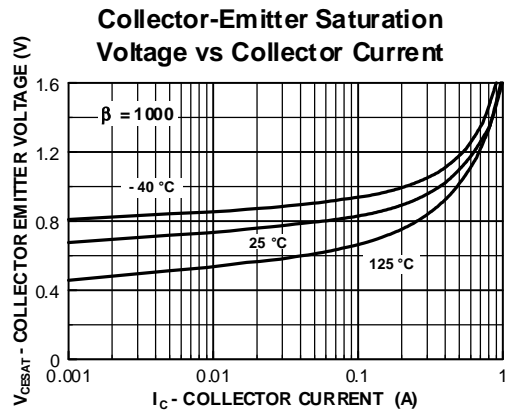
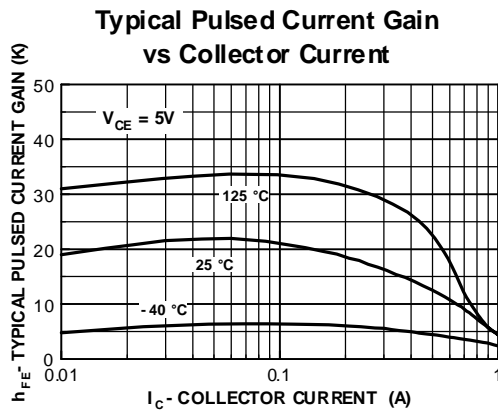

Typical Characteristics (continued)

Base-Emitter Saturation Voltage vs Collector Current

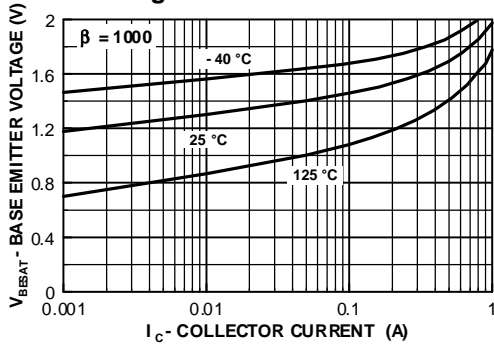

Base Emitter ON Voltage vs Collector Current

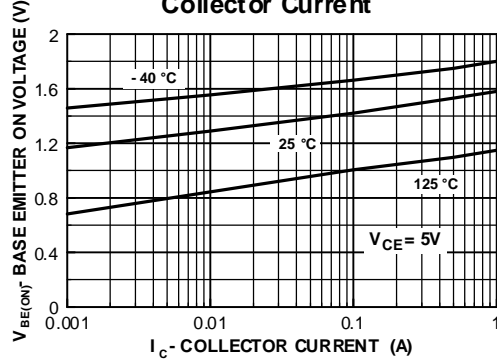

Collector-Cutoff Current vs Ambient Temperature

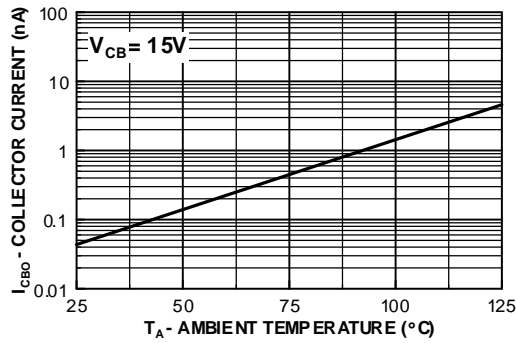

Input and Output Capacitance vs Reverse Bias Voltage

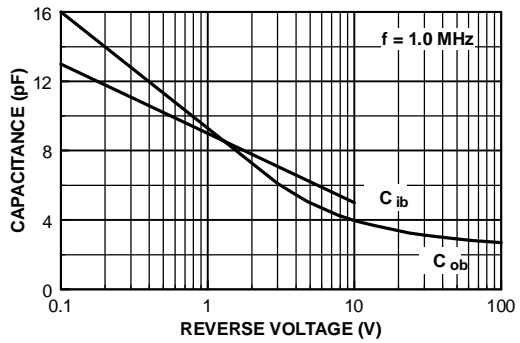

Power Dissipation vs Ambient Temperature

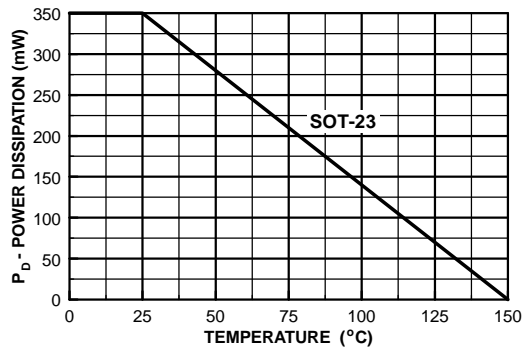

SOT-23 Tape and Reel Data



SOT-23 Packaging Configuration: Figure 10

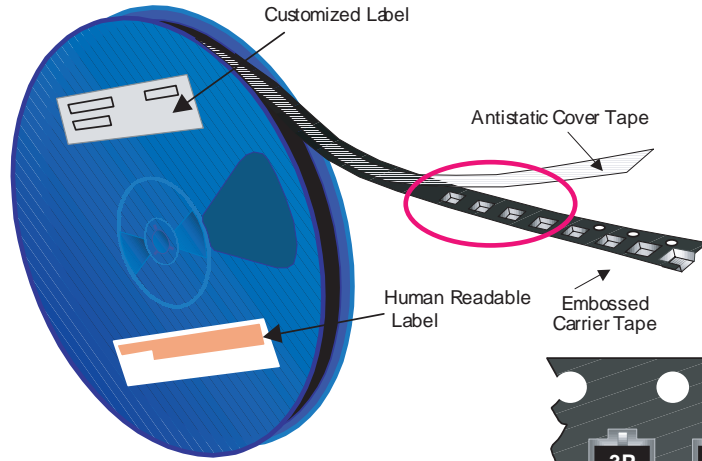

Packaging Description:

SOT-23 parts are shipped in tape. The carrier tape is made from a dissipative (carbon filled) polycarbonate resin. The cover tape is a multilayer film (Heat Activated Adhesive in nature) primarily composed of polyester film, adhesive layer, sealant, and anti-static sprayed agent. These reeled parts in standard option are shipped with 3,000 units per 7" or 177mm diameter reel. The reels are dark blue in color and is made of polystyrene plastic (anti-static coated). Other option comes in 10,000 units per 13" or 330mm diameter reel. This and some other options are described in the Packaging Information table.

These full reels are individually labeled and placed inside a standard intermediate made of recyclable corrugated brown paper with a Fairchild logo printing. One pizza box contains eight reels maximum. And these intermediate boxes are placed inside a labeled shipping box which comes in different sizes depending on the number of parts shipped.

| SOT-23 Packaging Information | | |
|------------------------------|-------------------------|------------|
| Packaging Option | Standard (no flow code) | D87Z |
| Packaging type | TNR | TNR |
| Qty per Reel/Tube/Bag | 3,000 | 10,000 |
| Reel Size | 7" Dia | 13" |
| Box Dimension (mm) | 187x107x183 | 343x343x64 |
| Max qty per Box | 24,000 | 30,000 |
| Weight per unit (gm) | 0.0082 | 0.0082 |
| Weight per Reel (kg) | 0.1175 | 0.4006 |
| Note/Comments | | |

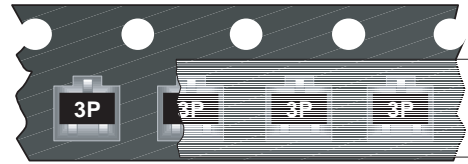

SOT-23 Unit Orientation

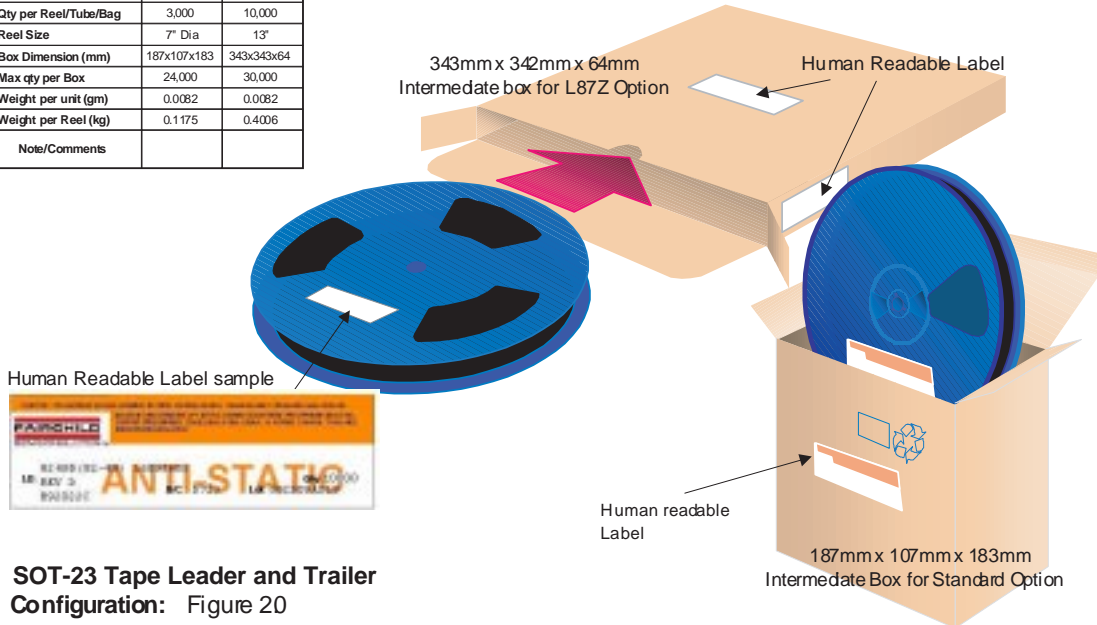

Human Readable Label sample



SOT-23 Tape Leader and Trailer Configuration: Figure 20

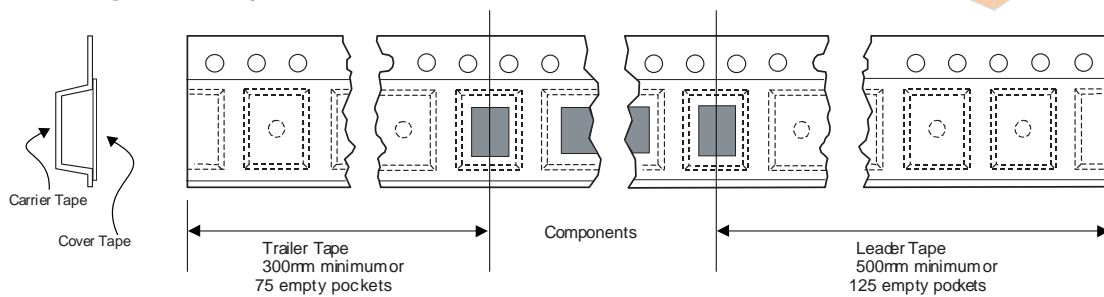

SOT-23 Tape and Reel Data, continued

SOT-23 Embossed Carrier Tape Configuration: Figure 3.0

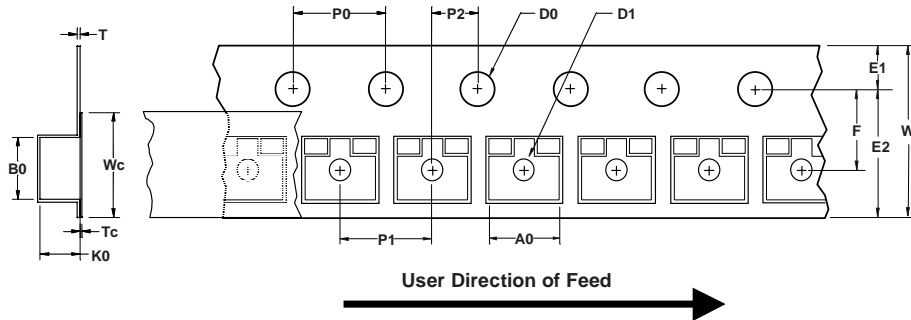

| Dimensions are in millimeter | | | | | | | | | | | | | | |
|------------------------------|---------------|---------------|-------------|---------------|-----------------|---------------|-------------|---------------|-------------|-------------|---------------|-----------------|-------------|---------------|
| Pkg type | A0 | B0 | W | D0 | D1 | E1 | E2 | F | P1 | P0 | K0 | T | Wc | Tc |
| SOT-23 (8mm) | 3.15 ±0.10 | 2.77 ±0.10 | 8.0 ±0.3 | 1.55 ±0.05 | 1.125 ±0.125 | 1.75 ±0.10 | 6.25 min | 3.50 ±0.05 | 4.0 ±0.1 | 4.0 ±0.1 | 1.30 ±0.10 | 0.228 ±0.013 | 5.2 ±0.3 | 0.06 ±0.02 |

Notes: A0, B0, and K0 dimensions are determined with respect to the EIA/Jedec RS-481 rotational and lateral movement requirements (see sketches A, B, and C).

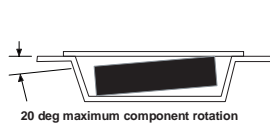

Sketch A (Side or Front Sectional View)
Component Rotation

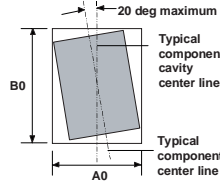

Sketch B (Top View)
Component Rotation

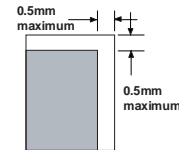

Sketch C (Top View)
Component lateral movement

SOT-23 Reel Configuration: Figure 4.0

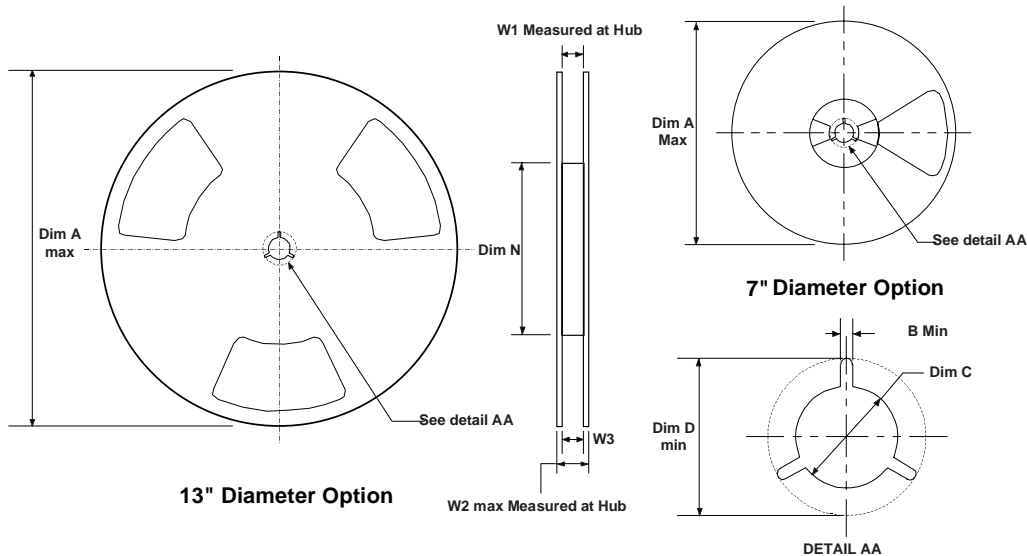

| Dimensions are in inches and millimeters | | | | | | | | | |
|--|-------------|---------------|--------------|-----------------------------------|---------------|-------------|-----------------------------------|---------------|----------------------------|
| Tape Size | Reel Option | Dim A | Dim B | Dim C | Dim D | Dim N | Dim W1 | Dim W2 | Dim W3 (LSL-USL) |
| 8mm | 7" Dia | 7.00 177.8 | 0.059 1.5 | 512 +0.020/-0.008 13 +0.5/-0.2 | 0.795 20.2 | 2.165 55 | 0.331 +0.059/-0.000 8.4 +1.5/0 | 0.567 14.4 | 0.311 -0.429 7.9 - 10.9 |
| 8mm | 13" Dia | 13.00 330 | 0.059 1.5 | 512 +0.020/-0.008 13 +0.5/-0.2 | 0.795 20.2 | 4.00 100 | 0.331 +0.059/-0.000 8.4 +1.5/0 | 0.567 14.4 | 0.311 -0.429 7.9 - 10.9 |

SOT-23 Package Dimensions



SOT-23 (FS PKG Code 49)

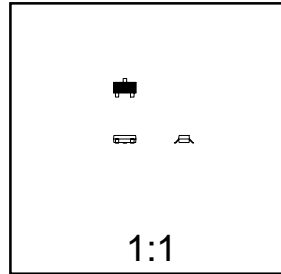
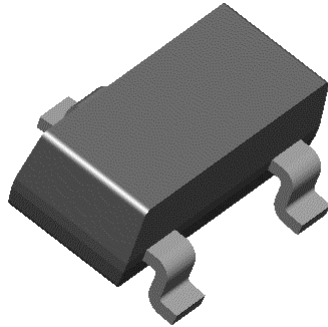

Scale 1:1 on letter size paper

Dimensions shown below are in:
inches [millimeters]

Part Weight per unit (gram): 0.0082

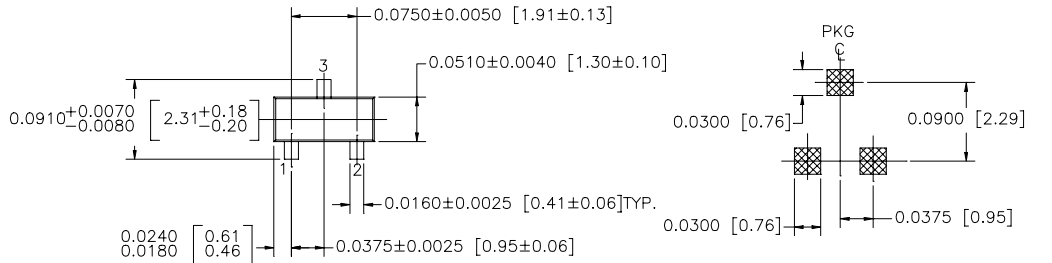

LAND PATTERN RECOMMENDATION

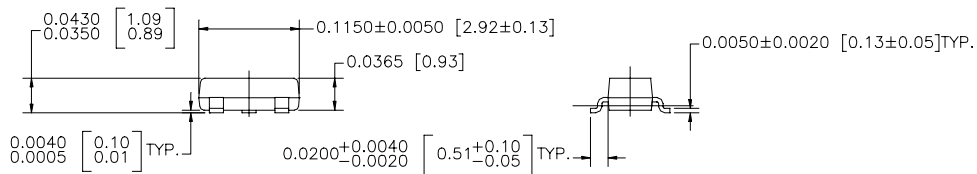

SOT 23, 3 LEADS LOW PROFILE

CONTROLLING DIMENSION IS INCH
VALUES IN [] ARE MILLIMETERS

NOTE : UNLESS OTHERWISE SPECIFIED

- STANDARD LEAD FINISH 150 MICRONS / 3.81 MICROMETERS
MINIMUM TIN / LEAD (SOLDER) ON ALLOY 42
- REFERENCE JEDEC REGISTRATION TO-236, VARIATION AB, ISSUE G, DATED JUL 1993

TRADEMARKS

The following are registered and unregistered trademarks Fairchild Semiconductor owns or is authorized to use and is not intended to be an exhaustive list of all such trademarks.

| | | | |
|-----------------------------------|--------------------------------------|----------------------------------|-------------------------|
| ACE ^x TM | FAST ^r TM | PowerTrench [®] | SyncFET TM |
| Bottomless TM | GlobalOptoisolator TM | QFET TM | TinyLogic TM |
| CoolFET TM | GTO TM | QS TM | UHC TM |
| CROSSVOLT TM | HiSeC TM | QT Optoelectronics TM | VCX TM |
| DO ^M E TM | ISOP ^L ANAR TM | Quiet Series TM | |
| E ² CMOS TM | MICROWIRE TM | SILENT SWITCHER [®] | |
| EnSigna TM | OPTOLOGIC TM | SMART START TM | |
| FACT TM | OPTOPLANAR TM | SuperSOT TM -3 | |
| FACT Quiet Series TM | PACMAN TM | SuperSOT TM -6 | |
| FAST [®] | POP TM | SuperSOT TM -8 | |

DISCLAIMER

FAIRCHILD SEMICONDUCTOR RESERVES THE RIGHT TO MAKE CHANGES WITHOUT FURTHER NOTICE TO ANY PRODUCTS HEREIN TO IMPROVE RELIABILITY, FUNCTION OR DESIGN. FAIRCHILD DOES NOT ASSUME ANY LIABILITY ARISING OUT OF THE APPLICATION OR USE OF ANY PRODUCT OR CIRCUIT DESCRIBED HEREIN; NEITHER DOES IT CONVEY ANY LICENSE UNDER ITS PATENT RIGHTS, NOR THE RIGHTS OF OTHERS.

LIFE SUPPORT POLICY

FAIRCHILD'S PRODUCTS ARE NOT AUTHORIZED FOR USE AS CRITICAL COMPONENTS IN LIFE SUPPORT DEVICES OR SYSTEMS WITHOUT THE EXPRESS WRITTEN APPROVAL OF FAIRCHILD SEMICONDUCTOR CORPORATION. As used herein:

1. Life support devices or systems are devices or systems which, (a) are intended for surgical implant into the body, or (b) support or sustain life, or (c) whose failure to perform when properly used in accordance with instructions for use provided in the labeling, can be reasonably expected to result in significant injury to the user.
2. A critical component is any component of a life support device or system whose failure to perform can be reasonably expected to cause the failure of the life support device or system, or to affect its safety or effectiveness.

PRODUCT STATUS DEFINITIONS

Definition of Terms

| Datasheet Identification | Product Status | Definition |
|--------------------------|------------------------|---|
| Advance Information | Formative or In Design | This datasheet contains the design specifications for product development. Specifications may change in any manner without notice. |
| Preliminary | First Production | This datasheet contains preliminary data, and supplementary data will be published at a later date. Fairchild Semiconductor reserves the right to make changes at any time without notice in order to improve design. |
| No Identification Needed | Full Production | This datasheet contains final specifications. Fairchild Semiconductor reserves the right to make changes at any time without notice in order to improve design. |
| Obsolete | Not In Production | This datasheet contains specifications on a product that has been discontinued by Fairchild semiconductor. The datasheet is printed for reference information only. |

ON Semiconductor and  are trademarks of Semiconductor Components Industries, LLC dba ON Semiconductor or its subsidiaries in the United States and/or other countries. ON Semiconductor owns the rights to a number of patents, trademarks, copyrights, trade secrets, and other intellectual property. A listing of ON Semiconductor's product/patent coverage may be accessed at www.onsemi.com/site/pdf/Patent-Marking.pdf. ON Semiconductor reserves the right to make changes without further notice to any products herein. ON Semiconductor makes no warranty, representation or guarantee regarding the suitability of its products for any particular purpose, nor does ON Semiconductor assume any liability arising out of the application or use of any product or circuit, and specifically disclaims any and all liability, including without limitation special, consequential or incidental damages. Buyer is responsible for its products and applications using ON Semiconductor products, including compliance with all laws, regulations and safety requirements or standards, regardless of any support or applications information provided by ON Semiconductor. "Typical" parameters which may be provided in ON Semiconductor data sheets and/or specifications can and do vary in different applications and actual performance may vary over time. All operating parameters, including "Typicals" must be validated for each customer application by customer's technical experts. ON Semiconductor does not convey any license under its patent rights nor the rights of others. ON Semiconductor products are not designed, intended, or authorized for use as a critical component in life support systems or any FDA Class 3 medical devices or medical devices with a same or similar classification in a foreign jurisdiction or any devices intended for implantation in the human body. Should Buyer purchase or use ON Semiconductor products for any such unintended or unauthorized application, Buyer shall indemnify and hold ON Semiconductor and its officers, employees, subsidiaries, affiliates, and distributors harmless against all claims, costs, damages, and expenses, and reasonable attorney fees arising out of, directly or indirectly, any claim of personal injury or death associated with such unintended or unauthorized use, even if such claim alleges that ON Semiconductor was negligent regarding the design or manufacture of the part. ON Semiconductor is an Equal Opportunity/Affirmative Action Employer. This literature is subject to all applicable copyright laws and is not for resale in any manner.

PUBLICATION ORDERING INFORMATION

LITERATURE FULFILLMENT:

Literature Distribution Center for ON Semiconductor
19521 E. 32nd Pkwy, Aurora, Colorado 80011 USA
Phone: 303-675-2175 or 800-344-3860 Toll Free USA/Canada
Fax: 303-675-2176 or 800-344-3867 Toll Free USA/Canada
Email: orderlit@onsemi.com

N. American Technical Support: 800-282-9855 Toll Free
USA/Canada
Europe, Middle East and Africa Technical Support:
Phone: 421 33 790 2910
Japan Customer Focus Center
Phone: 81-3-5817-1050

ON Semiconductor Website: www.onsemi.com
Order Literature: <http://www.onsemi.com/orderlit>
For additional information, please contact your local
Sales Representative