

## Switching Regulator Series

# Step-Down DC/DC Converter BD9E303EFJ-LB Evaluation Board

### BD9E303EFJ-EVK-001

BD9E303EFJ-EVK-001 Evaluation board delivers an output 5.0 volts from an input 7.0 to 36 volts using BD9E303EFJ-LB, a synchronous rectification step-down DC/DC converter integrated circuit, with output current rating of maximum 3A. The output voltage can be set by changing the external parts of circuit and the loop-response characteristics also can be adjusted by the phase compensation circuit.

## Performance specification

These are representative values, and it is not a guaranteed against the characteristics.

$V_{IN} = 24V$ ,  $V_{OUT} = 5.0V$ , Unless otherwise specified.

Parameter	Min	Typ	Max	Units	Conditions
Input Voltage Range	7.0		36	V	
Output Voltage		5.0		V	R1=30k $\Omega$ , R2=7.5k $\Omega$
Output Voltage Setting Range	$V_{IN} \times 0.06$ (NOTE1)		$V_{IN} \times 0.8$	V	
Output Current Range	0		3	A	
Loop Band Width		18.2		kHz	
Phase Margin		70.8		degrees	
Input Ripple Voltage		300		mVpp	$I_o = 3A$
Output Ripple Voltage		30		mVpp	$I_o = 3A$
Output Rising Time		2.2		ms	
Operating Frequency		300		kHz	
Maximum Efficiency		91.1		%	$I_o = 1.2A$

(NOTE1) However,  $(V_{IN} \times 0.06) \geq 1.0V$

## Operation Procedures

### 1. Necessary equipments

- (1) DC power-supply of 7.0V to 36V/3A
- (2) Maximum 3A load
- (3) DC voltmeter

### 2. Connecting the equipments

- (1) DC power-supply presets to 24V and then the power output turns off.
- (2) The maximum load should be set at 3A and over it will be disabled.
- (3) Check Jumper pin of SW1 is short, between intermediate-terminal and OFF-side terminal.
- (4) Connect positive-terminal of power-supply to VIN+ terminal and negative-terminal to GND-terminal with a pair of wires.
- (5) Connect load's positive-terminal to VOUT+ terminal and negative-terminal to GND-terminal with a pair of wires.
- (6) Connect positive-terminal of DC voltmeter 1 to TP1 and negative-terminal to TP2 for input-voltage measurement.
- (7) Connect positive-terminal of DC voltmeter 2 to TP3 and negative-terminal to TP4 for output-voltage measurement.
- (8) DC power-supply output is turned ON.
- (9) IC is enable (EN) by shorting Jumper-pin of SW1 between intermediate-terminal and ON-side terminal.
- (10) Check DC voltmeter 2 displays 5.0V.
- (11) The load is enabled.
- (12) Check at DC voltmeter 1 whether the voltage-drop (loss) is not caused by the wire's resistance.

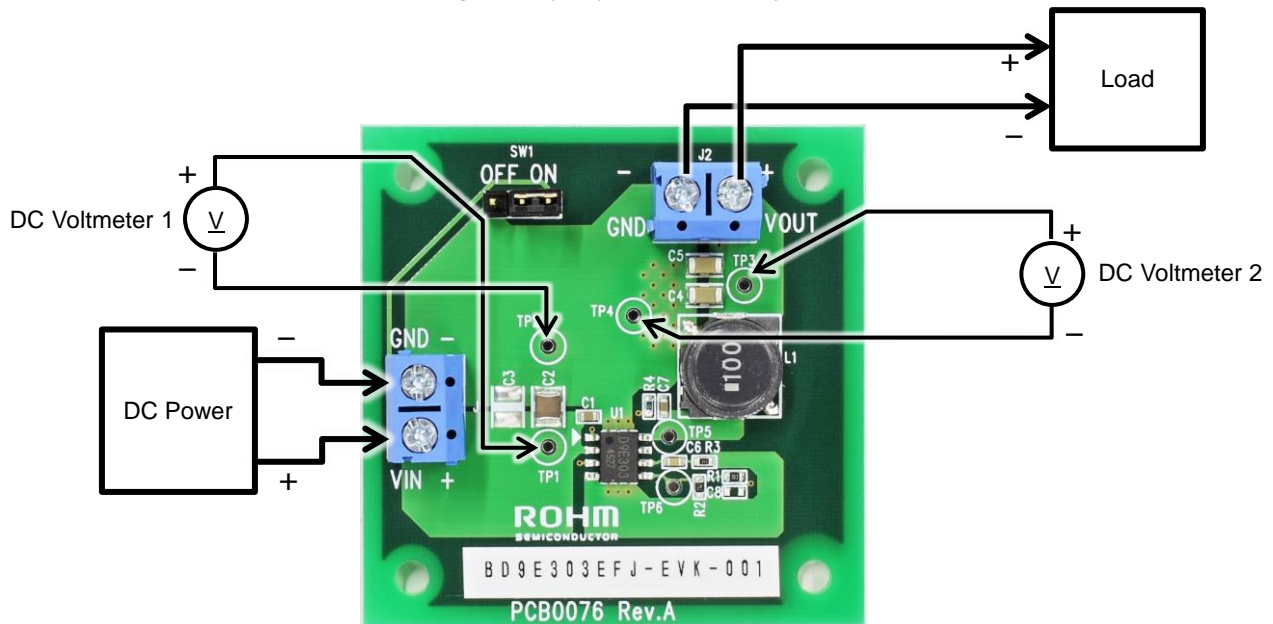

Figure 1. Connection Diagram

### Enable-Pin

To minimize current consumption during standby-mode and normal operation, Enable-mode can be switched by controlling EN pin (3pin) of the IC. Standby-mode is enabled by shorting Jumper-pin of SW1 between intermediate-terminal and OFF-side terminal and normal-mode operation by shorting between intermediate-terminal and ON-side terminal.

It also can be switched between standby-mode and normal-mode operation by removing Jumper-pin and controlling the voltage between EN and GND-terminal. Standby-mode is enabled when the voltage of EN is under 0.8V, and normal-mode operation when it is over 2.5V.

Circuit Diagram

$V_{IN} = 7.2V$  to  $36V$ ,  $V_{OUT} = 5.0V$

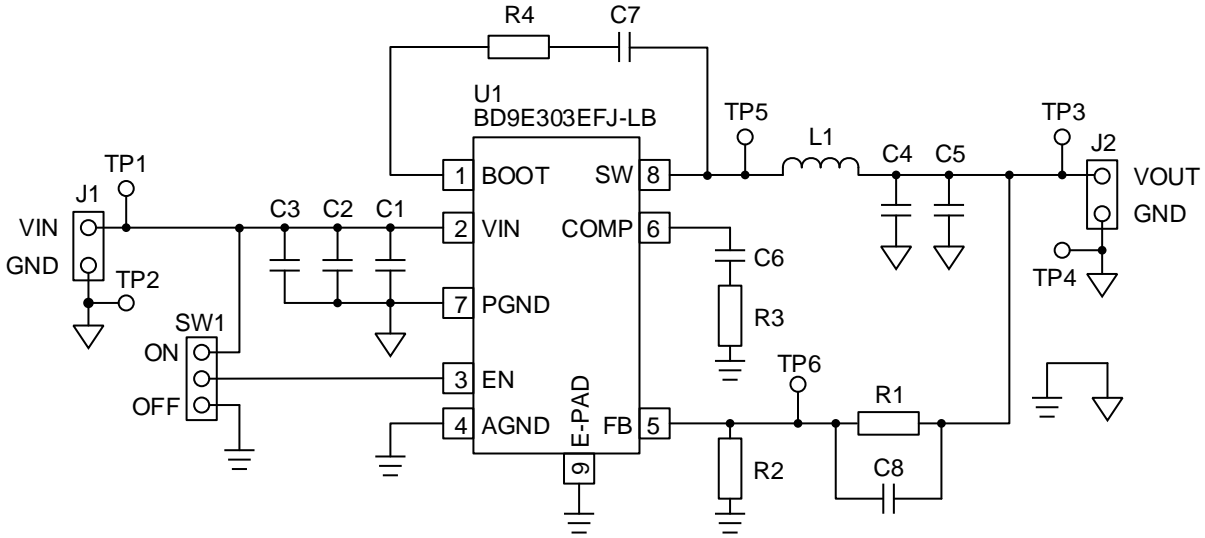

Figure 2. BD9E303EFJ-EVK-001 Circuit Diagram

Bill of Materials

Count	Reference Designator	Type	Value	Description	Manufacturer Part Number	Manufacturer	Configuration (mm)
2	C1, C7	Ceramic Capacitor	0.1μF	50V, B, ±20%	GRM188B31H104MA92	MURATA	1608
1	C2	Ceramic Capacitor	10μF	50V, B, ±10%	GRM32EB31H106KA12	MURATA	3225
0	C3	Ceramic Capacitor	-	Not installed	-	-	3225
2	C4, C5	Ceramic Capacitor	22μF	10V, B, ±10%	GRM31CB31A226KE19	MURATA	3216
1	C6	Ceramic Capacitor	6800pF	50V, B, ±10%	GRM188B11H682KA01	MURATA	1608
0	C8	Ceramic Capacitor	-	Not installed	-	-	1608
1	L1	Inductor	10μH	±20%, DCR=24mΩmax, 4.49A	NS10155T100MNV	TAIYO YUDEN	101101
1	R1	Resistor	30kΩ	1/10W, 50V, 1%	MCR03EZPFX3002	ROHM	1608
1	R2	Resistor	7.5kΩ	1/10W, 50V, 1%	MCR03EZPFX7501	ROHM	1608
1	R3	Resistor	15kΩ	1/10W, 50V, 1%	MCR03EZPFX1502	ROHM	1608
1	R4	Resistor	0Ω	Jumper	MCR03EZPJ000	ROHM	1608
1	SW1	Pin header	-	2.54mm × 3 contacts	PH-1x03SG 61300311121	USECONN Würth Electronics Inc.	- -
1	U1	IC	-	Buck DC/DC Converter	BD9E303EFJ-LB	ROHM	HTSOP-J8
2	J1, J2	Terminal Block	-	2 contacts, 15A, 14 to 22AWG	TB111-2-2-U-1-1 OSTTC022162	Alphaplus Connectors & Cables On Shore Technology Inc	- -
1	-	Jumper	-	Jumper pin for SW1	MJ254-6BK 969102-0000-DA	USECONN 3M	- -

Layout

PCB size: 50mmx50mmx1.6mm

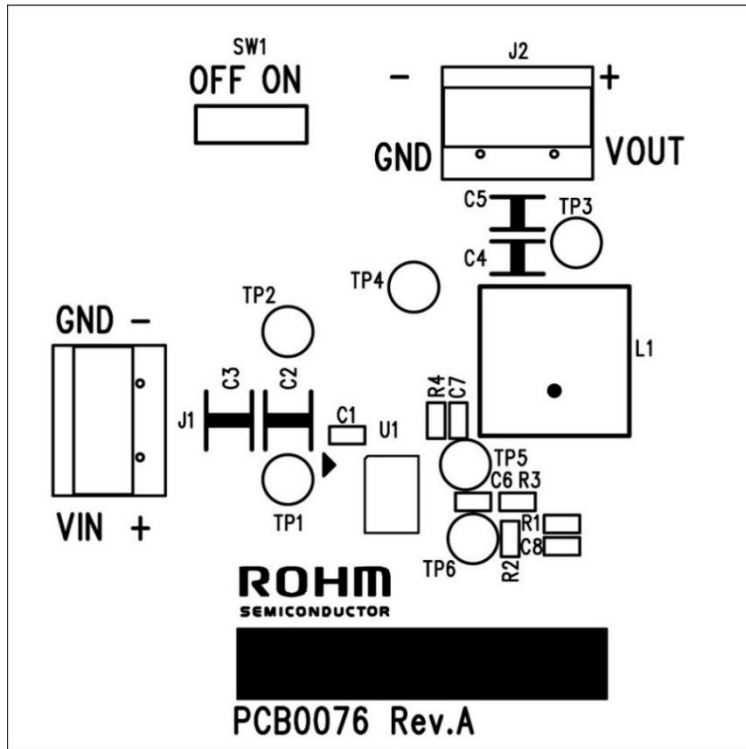

Figure 3. Top Silk Screen (Top view)

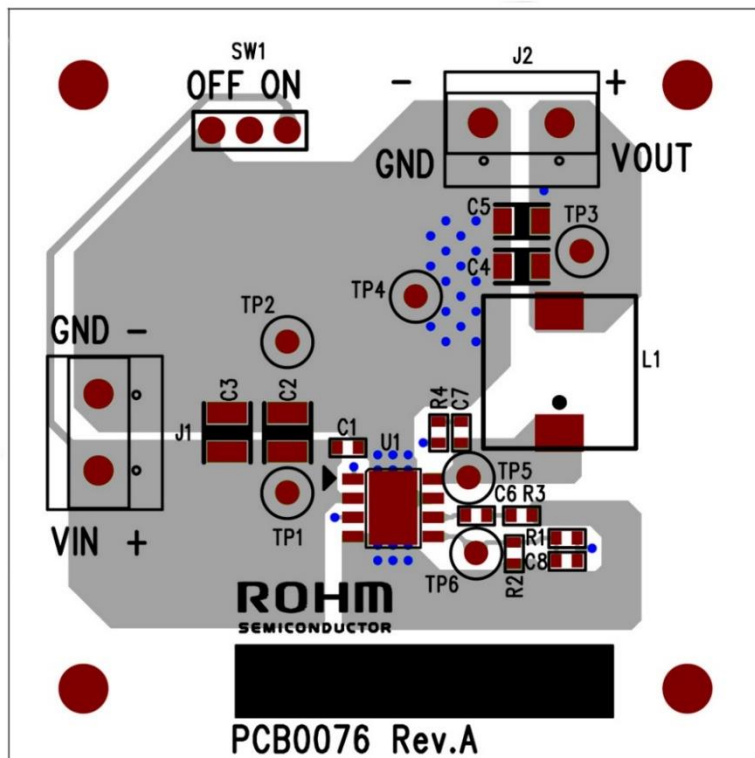

Figure 4. Top Silk Screen and Layout (Top view)

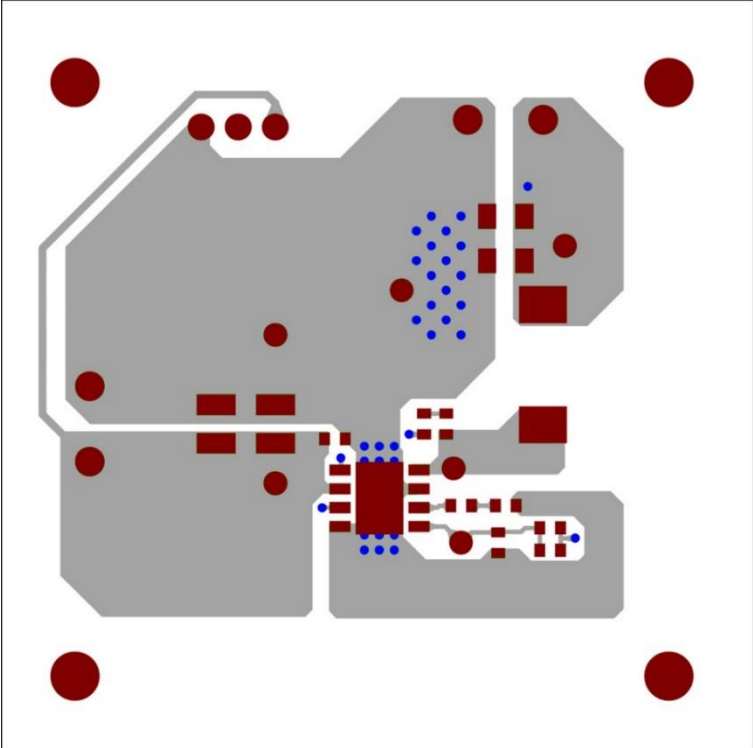

Figure 5. Top Side Layout (Top view)

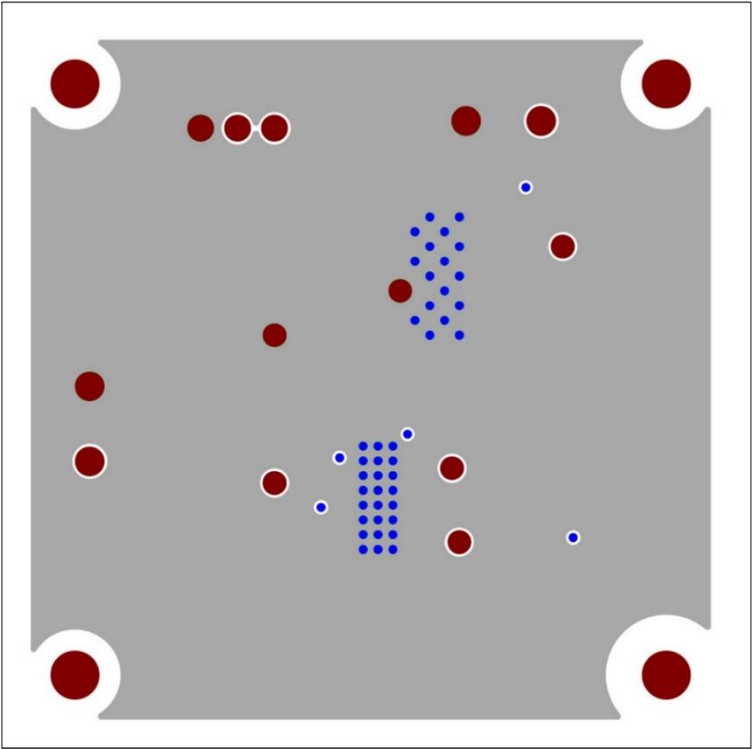

Figure 6. L2 Layout (Top view)

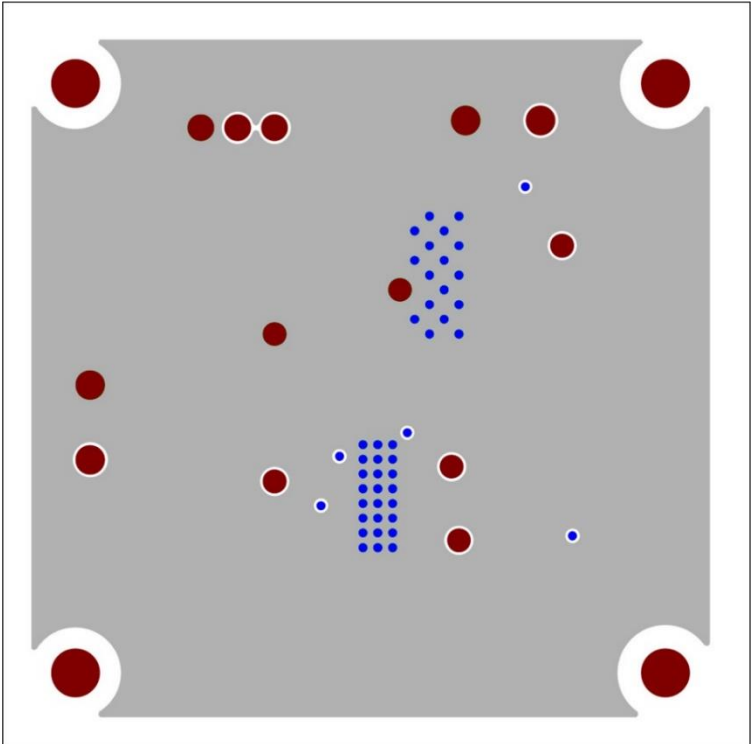

Figure 7. L3 Layout (Top view)

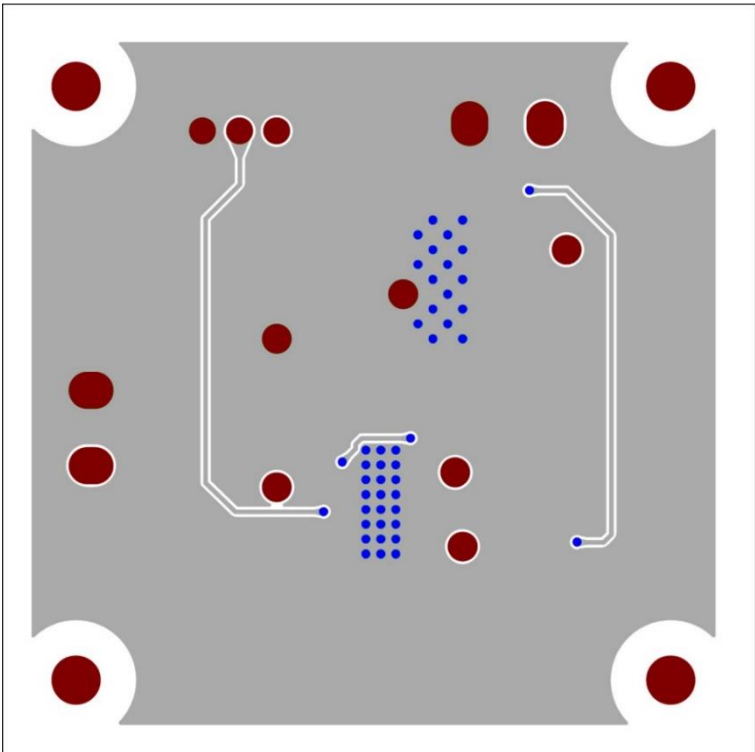

Figure 8. Bottom Side Layout (Top view)

Reference Application Data

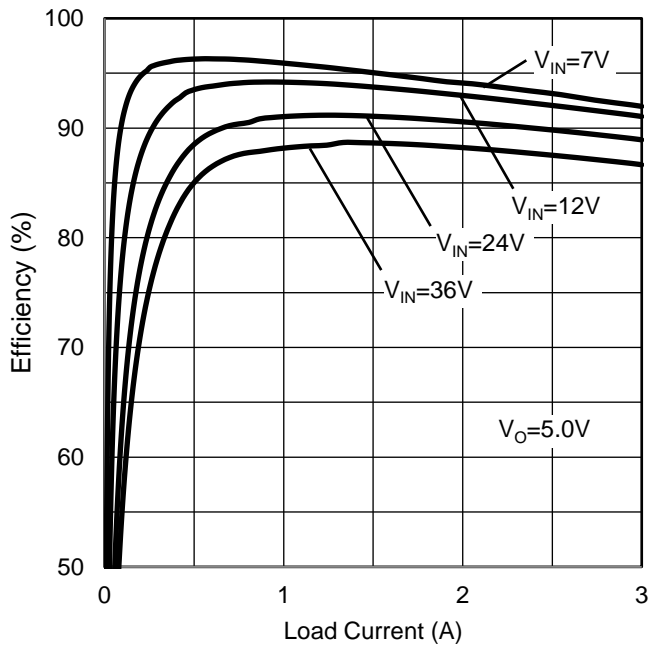

Figure 9. Efficiency vs Load Current

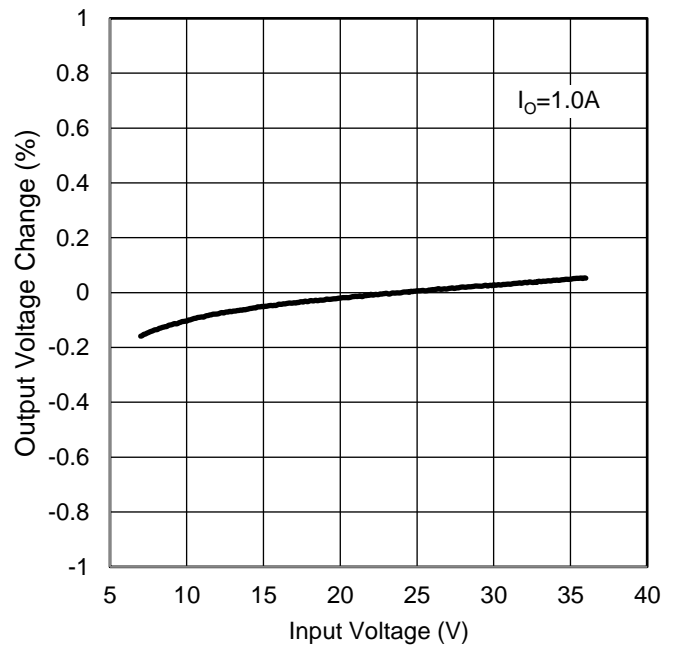

Figure 10. Line Regulation

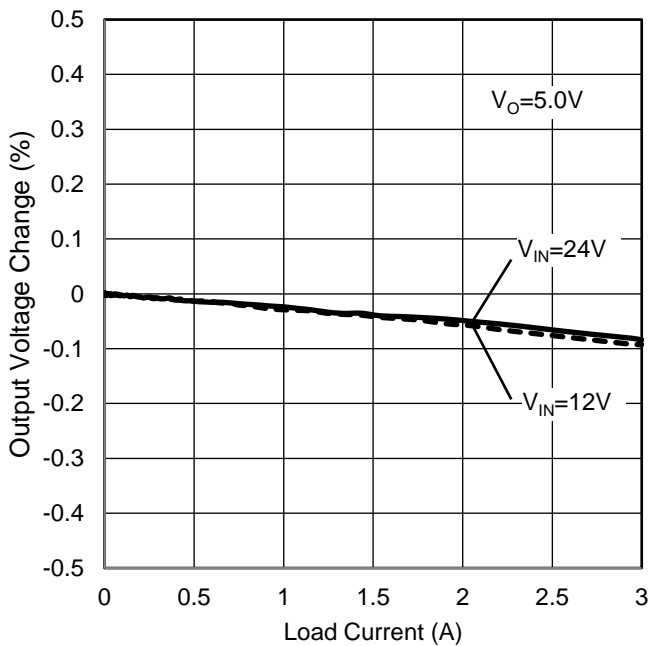

Figure 11. Load Regulation

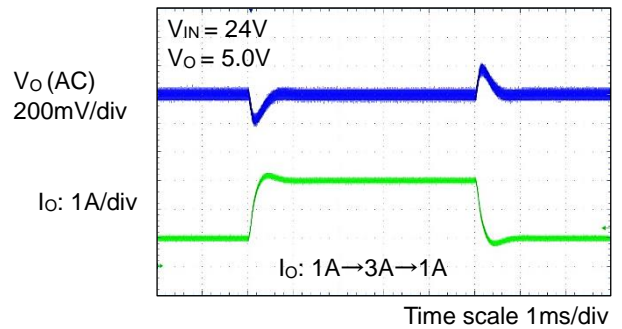
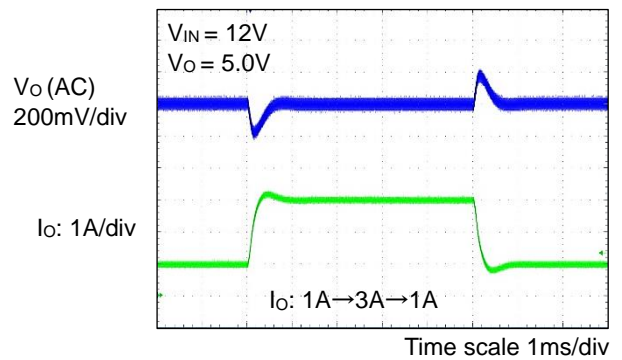

Figure 12. Load Transient Characteristics

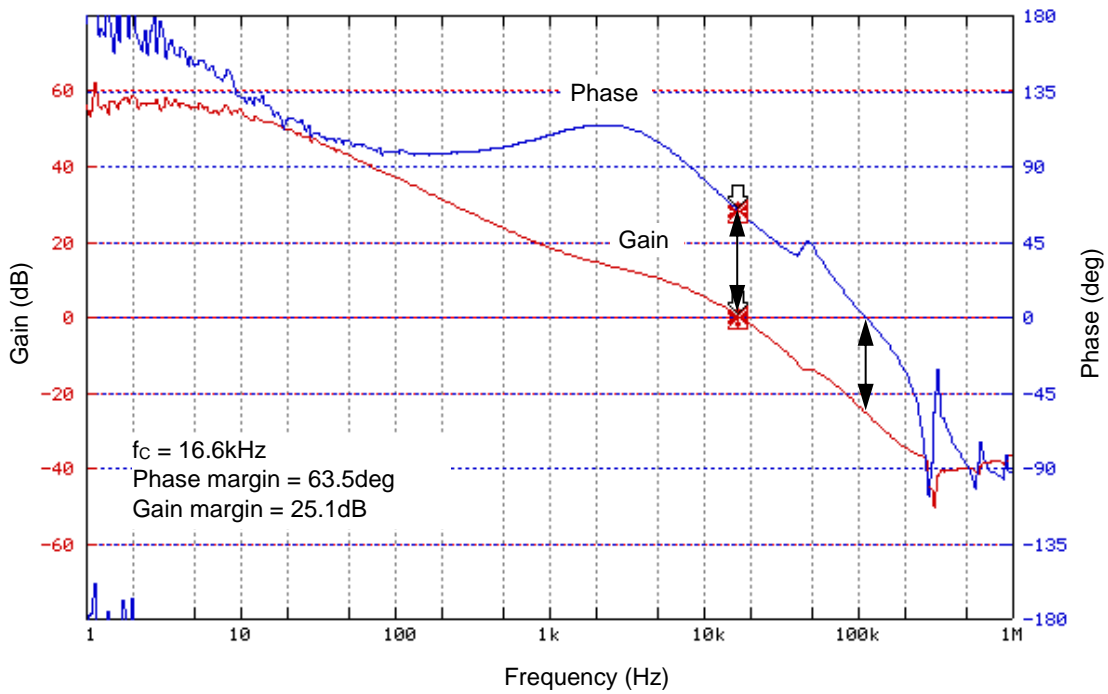

Figure 13. Loop Response  $V_{IN} = 12\text{V}$ ,  $V_O = 5.0\text{V}$ ,  $I_O = 3\text{A}$

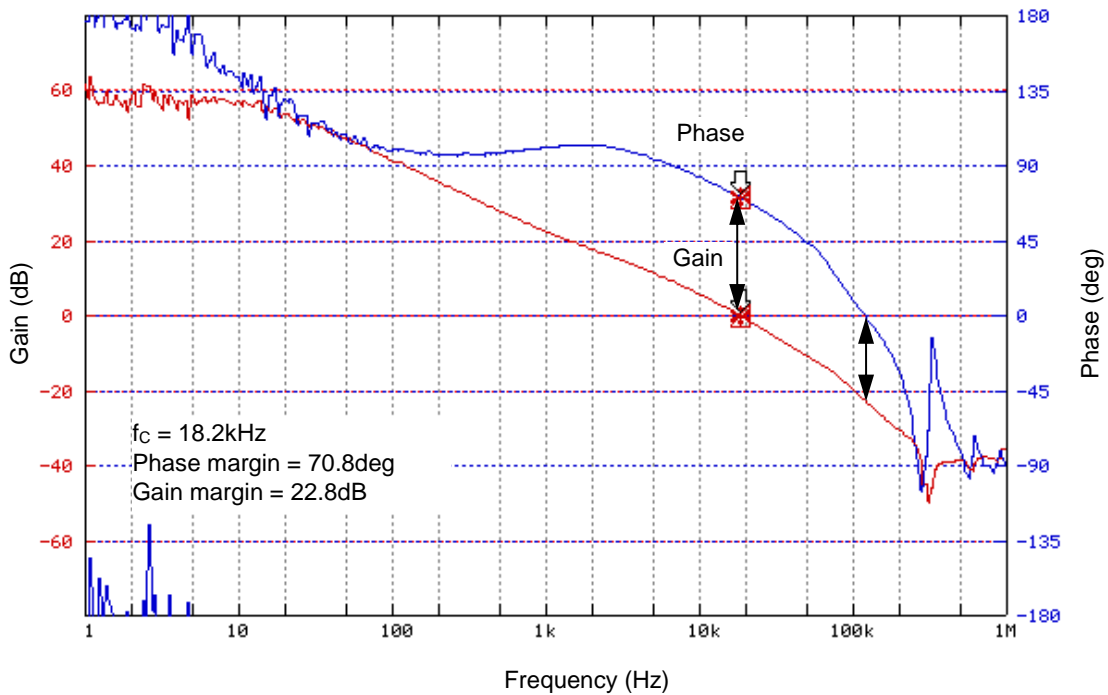

Figure 14. Loop Response  $V_{IN} = 24\text{V}$ ,  $V_O = 5.0\text{V}$ ,  $I_O = 3\text{A}$



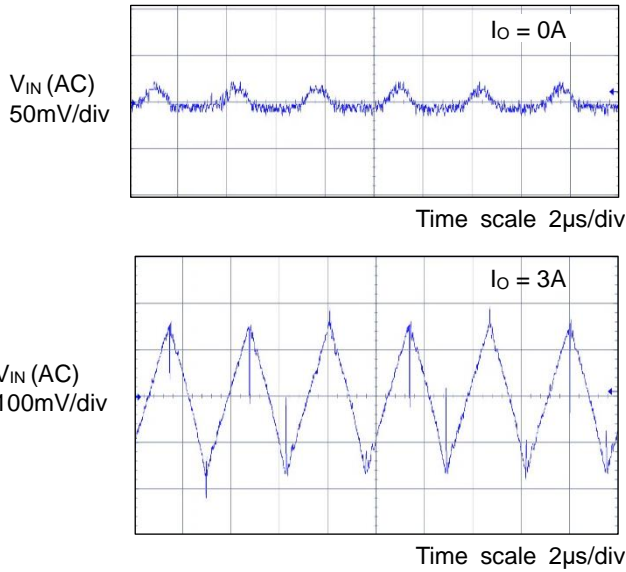

Figure 15. Input Voltage Ripple Wave  
 $V_{IN} = 12V, V_O = 5.0V$

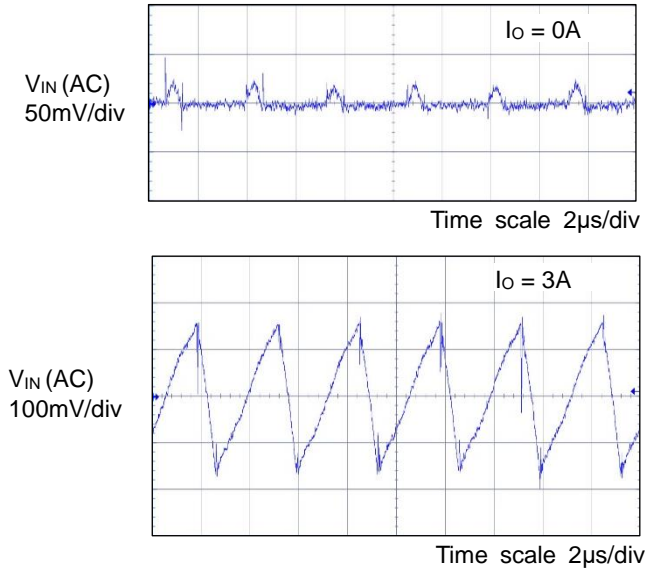

Figure 16. Input Voltage Ripple Wave  
 $V_{IN} = 24V, V_O = 5.0V$

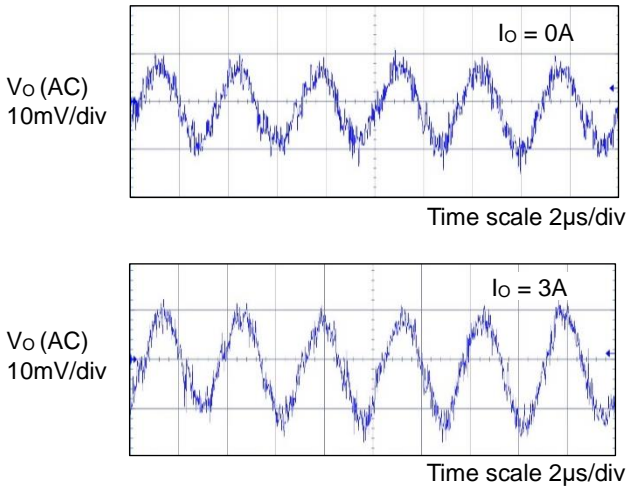

Figure 17. Output Voltage Ripple Wave  
 $V_{IN} = 12V, V_O = 5.0V$

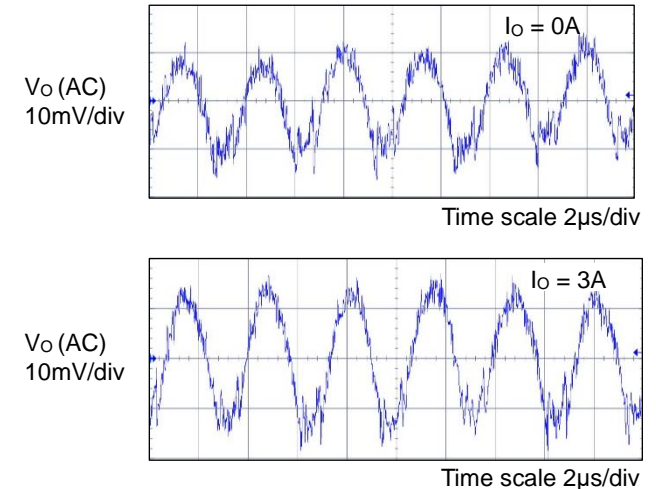

Figure 18. Output Voltage Ripple Wave  
 $V_{IN} = 24V, V_O = 5.0V$

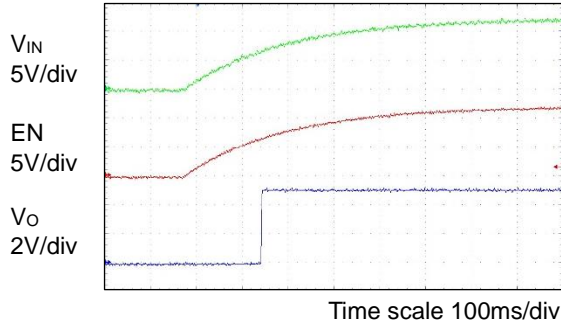

Figure 19. Start-up EN =  $V_{IN}$   
 $V_{IN} = 12V, V_O = 5.0V, I_O = 0A$

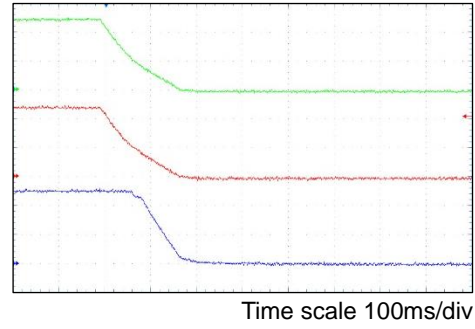

Figure 20. Power-down EN =  $V_{IN}$   
 $V_{IN} = 12V, V_O = 5.0V, I_O = 0A$

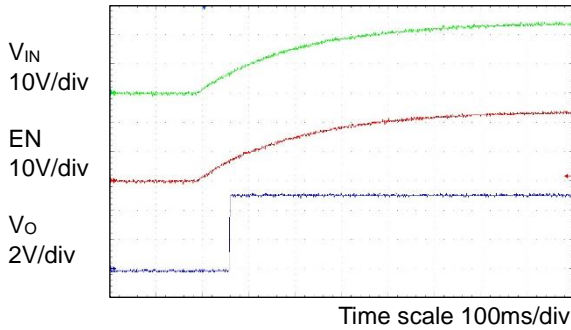

Figure 21. Start-up EN =  $V_{IN}$   
 $V_{IN} = 24V, V_O = 5.0V, I_O = 0A$

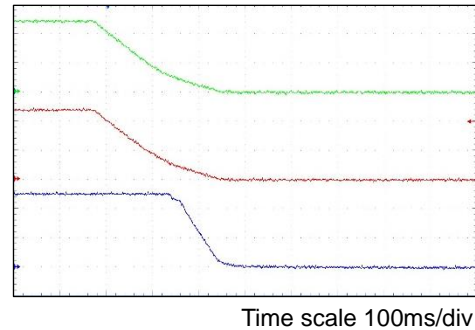

Figure 22. Power-down EN =  $V_{IN}$   
 $V_{IN} = 24V, V_O = 5.0V, I_O = 0A$

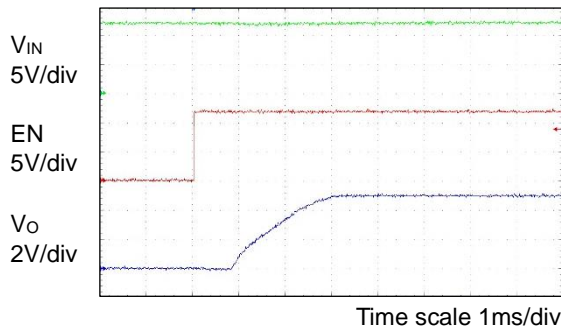

Figure 23. Start-up by EN  
 $V_{IN} = 12V, V_O = 5.0V, I_O = 0A$

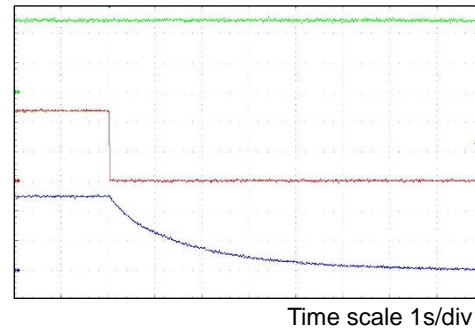

Figure 24. Power-down by EN  
 $V_{IN} = 12V, V_O = 5.0V, I_O = 0A$

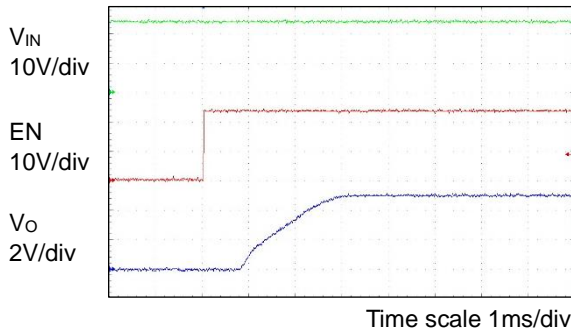

Figure 25. Start-up by EN  
 $V_{IN} = 24V, V_O = 5.0V, I_O = 0A$

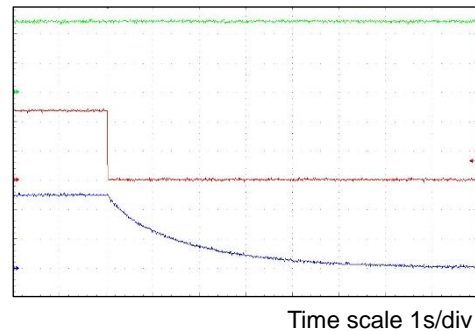

Figure 26. Power-down by EN  
 $V_{IN} = 24V, V_O = 5.0V, I_O = 0A$

## Notes

- 1) The information contained herein is subject to change without notice.
- 2) Before you use our Products, please contact our sales representative and verify the latest specifications :
- 3) Although ROHM is continuously working to improve product reliability and quality, semiconductors can break down and malfunction due to various factors.  
Therefore, in order to prevent personal injury or fire arising from failure, please take safety measures such as complying with the derating characteristics, implementing redundant and fire prevention designs, and utilizing backups and fail-safe procedures. ROHM shall have no responsibility for any damages arising out of the use of our Products beyond the rating specified by ROHM.
- 4) Examples of application circuits, circuit constants and any other information contained herein are provided only to illustrate the standard usage and operations of the Products. The peripheral conditions must be taken into account when designing circuits for mass production.
- 5) The technical information specified herein is intended only to show the typical functions of and examples of application circuits for the Products. ROHM does not grant you, explicitly or implicitly, any license to use or exercise intellectual property or other rights held by ROHM or any other parties. ROHM shall have no responsibility whatsoever for any dispute arising out of the use of such technical information.
- 6) The Products specified in this document are not designed to be radiation tolerant.
- 7) For use of our Products in applications requiring a high degree of reliability (as exemplified below), please contact and consult with a ROHM representative : transportation equipment (i.e. cars, ships, trains), primary communication equipment, traffic lights, fire/crime prevention, safety equipment, medical systems, servers, solar cells, and power transmission systems.
- 8) Do not use our Products in applications requiring extremely high reliability, such as aerospace equipment, nuclear power control systems, and submarine repeaters.
- 9) ROHM shall have no responsibility for any damages or injury arising from non-compliance with the recommended usage conditions and specifications contained herein.
- 10) ROHM has used reasonable care to ensure the accuracy of the information contained in this document. However, ROHM does not warrants that such information is error-free, and ROHM shall have no responsibility for any damages arising from any inaccuracy or misprint of such information.
- 11) Please use the Products in accordance with any applicable environmental laws and regulations, such as the RoHS Directive. For more details, including RoHS compatibility, please contact a ROHM sales office. ROHM shall have no responsibility for any damages or losses resulting non-compliance with any applicable laws or regulations.
- 12) When providing our Products and technologies contained in this document to other countries, you must abide by the procedures and provisions stipulated in all applicable export laws and regulations, including without limitation the US Export Administration Regulations and the Foreign Exchange and Foreign Trade Act.
- 13) This document, in part or in whole, may not be reprinted or reproduced without prior consent of ROHM.



Thank you for your accessing to ROHM product informations.  
More detail product informations and catalogs are available, please contact us.

## ROHM Customer Support System

<http://www.rohm.com/contact/>