



Is Now Part of



ON Semiconductor®

To learn more about ON Semiconductor, please visit our website at

www.onsemi.com

ON Semiconductor and the ON Semiconductor logo are trademarks of Semiconductor Components Industries, LLC dba ON Semiconductor or its subsidiaries in the United States and/or other countries. ON Semiconductor owns the rights to a number of patents, trademarks, copyrights, trade secrets, and other intellectual property. A listing of ON Semiconductor's product/patent coverage may be accessed at www.onsemi.com/site/pdf/Patent-Marking.pdf. ON Semiconductor reserves the right to make changes without further notice to any products herein. ON Semiconductor makes no warranty, representation or guarantee regarding the suitability of its products for any particular purpose, nor does ON Semiconductor assume any liability arising out of the application or use of any product or circuit, and specifically disclaims any and all liability, including without limitation special, consequential or incidental damages. Buyer is responsible for its products and applications using ON Semiconductor products, including compliance with all laws, regulations and safety requirements or standards, regardless of any support or applications information provided by ON Semiconductor. "Typical" parameters which may be provided in ON Semiconductor data sheets and/or specifications can and do vary in different applications and actual performance may vary over time. All operating parameters, including "Typicals" must be validated for each customer application by customer's technical experts. ON Semiconductor does not convey any license under its patent rights nor the rights of others. ON Semiconductor products are not designed, intended, or authorized for use as a critical component in life support systems or any FDA Class 3 medical devices or medical devices with a same or similar classification in a foreign jurisdiction or any devices intended for implantation in the human body. Should Buyer purchase or use ON Semiconductor products for any such unintended or unauthorized application, Buyer shall indemnify and hold ON Semiconductor and its officers, employees, subsidiaries, affiliates, and distributors harmless against all claims, costs, damages, and expenses, and reasonable attorney fees arising out of, directly or indirectly, any claim of personal injury or death associated with such unintended or unauthorized use, even if such claim alleges that ON Semiconductor was negligent regarding the design or manufacture of the part. ON Semiconductor is an Equal Opportunity/Affirmative Action Employer. This literature is subject to all applicable copyright laws and is not for resale in any manner.

FCP13N60N / FCPF13N60NT

N-Channel SupreMOS® MOSFET

600 V, 13 A, 258 mΩ

Features

- $R_{DS(on)} = 220 \text{ m}\Omega$ (Typ.) @ $V_{GS} = 10 \text{ V}$, $I_D = 6.5 \text{ A}$
- Ultra Low Gate Charge (Typ. $Q_g = 30.4 \text{ nC}$)
- Low Effective Output Capacitance (Typ. $C_{oss(eff.)} = 145 \text{ pF}$)
- 100% Avalanche Tested
- RoHS Compliant

Application

- LCD/LED/PDP TV
- Lighting
- Solar Inverter
- AC-DC Power Supply

Description

The SupreMOS® MOSFET is Fairchild Semiconductor's next generation of high voltage super-junction (SJ) technology employing a deep trench filling process that differentiates it from the conventional SJ MOSFETs. This advanced technology and precise process control provides lowest R_{sp} on-resistance, superior switching performance and ruggedness. SupreMOS MOSFET is suitable for high frequency switching power converter applications such as PFC, server/telecom power, FPD TV power, ATX power and industrial power applications.

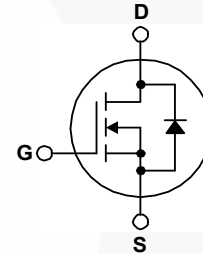
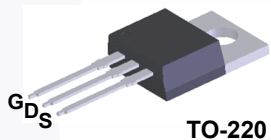

MOSFET Maximum Ratings $T_C = 25^\circ\text{C}$ unless otherwise noted.

Symbol	Parameter	FCP13N60N	FCPF13N60NT	Unit
V_{DSS}	Drain to Source Voltage	600		V
V_{GSS}	Gate to Source Voltage	±30		V
I_D	Drain Current	- Continuous ($T_C = 25^\circ\text{C}$)	13	13*
		- Continuous ($T_C = 100^\circ\text{C}$)	8.2	8.2*
I_{DM}	Drain Current	- Pulsed (Note 1)	39	39
E_{AS}	Single Pulsed Avalanche Energy (Note 2)	235		mJ
I_{AR}	Avalanche Current (Note 1)	4.3		A
E_{AR}	Repetitive Avalanche Energy (Note 1)	1.16		mJ
dv/dt	MOSFET dv/dt	100		V/ns
	Peak Diode Recovery dv/dt (Note 3)	20		V/ns
P_D	Power Dissipation	($T_C = 25^\circ\text{C}$)	116	33.8
		- Derate Above 25°C	0.93	0.27
T_J, T_{STG}	Operating and Storage Temperature Range	-55 to +150		$^\circ\text{C}$
T_L	Maximum Lead Temperature for Soldering, 1/8" from Case for 5 Seconds	300		$^\circ\text{C}$

*Drain current limited by maximum junction temperature.

Thermal Characteristics

Symbol	Parameter	FCP13N60N	FCPF13N60NT	Unit
$R_{\theta JC}$	Thermal Resistance, Junction to Case, Max.	1.07	3.7	$^\circ\text{C}/\text{W}$
$R_{\theta JA}$	Thermal Resistance, Junction to Ambient, Max.	62.5	62.5	

Package Marking and Ordering Information

Part Number	Top Mark	Package	Packing Method	Reel Size	Tape Width	Quantity
FCP13N60N	FCP13N60N	TO-220	Tube	N/A	N/A	50 units
FCPF13N60NT	FCPF13N60NT	TO-220F	Tube	N/A	N/A	50 units

Electrical Characteristics $T_C = 25^\circ\text{C}$ unless otherwise noted.

Symbol	Parameter	Test Conditions	Min.	Typ.	Max.	Unit
--------	-----------	-----------------	------	------	------	------

Off Characteristics

BV_{DSS}	Drain to Source Breakdown Voltage	$I_D = 1\text{ mA}, V_{GS} = 0\text{ V}, T_C = 25^\circ\text{C}$	600	-	-	V
$\Delta BV_{DSS} / \Delta T_J$	Breakdown Voltage Temperature Coefficient	$I_D = 1\text{ mA}, \text{Referenced to } 25^\circ\text{C}$	-	0.73	-	$V/^\circ\text{C}$
I_{DSS}	Zero Gate Voltage Drain Current	$V_{DS} = 480\text{ V}, V_{GS} = 0\text{ V}$	-	-	10	μA
		$V_{DS} = 480\text{ V}, V_{GS} = 0\text{ V}, T_C = 125^\circ\text{C}$	-	-	100	
I_{GSS}	Gate to Body Leakage Current	$V_{GS} = \pm 30\text{ V}, V_{DS} = 0\text{ V}$	-	-	± 100	nA

On Characteristics

$V_{GS(th)}$	Gate Threshold Voltage	$V_{GS} = V_{DS}, I_D = 250\text{ }\mu\text{A}$	2.0	-	4.0	V
$R_{DS(on)}$	Static Drain to Source On Resistance	$V_{GS} = 10\text{ V}, I_D = 6.5\text{ A}$	-	0.220	0.258	Ω
g_{FS}	Forward Transconductance	$V_{DS} = 40\text{ V}, I_D = 6.5\text{ A}$	-	16.3	-	S

Dynamic Characteristics

C_{iss}	Input Capacitance	$V_{DS} = 100\text{ V}, V_{GS} = 0\text{ V}, f = 1\text{ MHz}$	-	1325	1765	pF
C_{oss}	Output Capacitance		-	50	65	pF
C_{riss}	Reverse Transfer Capacitance		-	3	5	pF
C_{oss}	Output Capacitance	$V_{DS} = 380\text{ V}, V_{GS} = 0\text{ V}, f = 1\text{ MHz}$	-	30	-	pF
$C_{oss(eff.)}$	Effective Output Capacitance	$V_{DS} = 0\text{ V to } 480\text{ V}, V_{GS} = 0\text{ V}$	-	145	-	pF
$Q_{g(tot)}$	Total Gate Charge at 10V	$V_{DS} = 380\text{ V}, I_D = 6.5\text{ A}, V_{GS} = 10\text{ V}$	-	30.4	39.5	nC
Q_{gs}	Gate to Source Gate Charge		-	6.0	-	nC
Q_{gd}	Gate to Drain "Miller" Charge		(Note 4)	-	9.5	-
ESR	Equivalent Series Resistance (G-S)	$f = 1\text{ MHz}$	-	2.8	-	Ω

Switching Characteristics

$t_{d(on)}$	Turn-On Delay Time	$V_{DD} = 380\text{ V}, I_D = 6.5\text{ A}, V_{GS} = 10\text{ V}, R_G = 4.7\text{ }\Omega$	-	14.5	39	ns
t_r	Turn-On Rise Time		-	10.6	31.2	ns
$t_{d(off)}$	Turn-Off Delay Time		-	45	100	ns
t_f	Turn-Off Fall Time		(Note 4)	-	9.8	29.6

Drain-Source Diode Characteristics

I_S	Maximum Continuous Drain to Source Diode Forward Current	-	-	13*	A	
I_{SM}	Maximum Pulsed Drain to Source Diode Forward Current	-	-	39	A	
V_{SD}	Drain to Source Diode Forward Voltage	$V_{GS} = 0\text{ V}, I_{SD} = 6.5\text{ A}$	-	-	1.2	V
t_{rr}	Reverse Recovery Time	$V_{GS} = 0\text{ V}, I_{SD} = 6.5\text{ A}$	-	287	-	ns
Q_{rr}	Reverse Recovery Charge	$di_F/dt = 100\text{ A}/\mu\text{s}$	-	3.5	-	μC

Notes:

1. Repetitive rating: pulse-width limited by maximum junction temperature.
2. $I_{AS} = 4.3\text{ A}, R_G = 25\text{ }\Omega$, starting $T_J = 25^\circ\text{C}$.
3. $I_{SD} \leq 13\text{ A}, di/dt \leq 200\text{ A}/\mu\text{s}, V_{DD} \leq BV_{DSS}$, starting $T_J = 25^\circ\text{C}$.
4. Essentially independent of operating temperature typical characteristics.

Typical Performance Characteristics

Figure 1. On-Region Characteristics

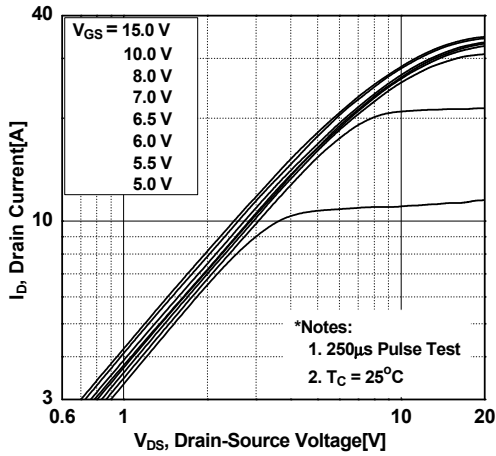

Figure 2. Transfer Characteristics

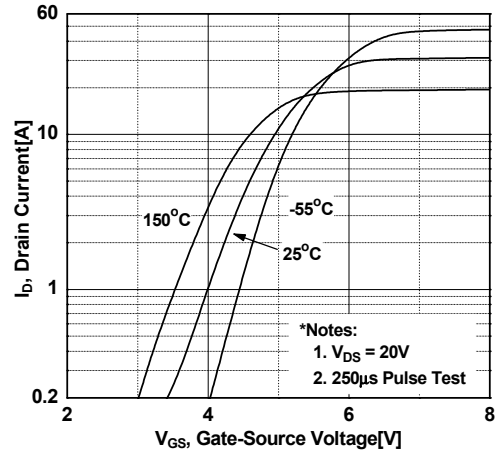

Figure 3. On-Resistance Variation vs. Drain Current and Gate Voltage

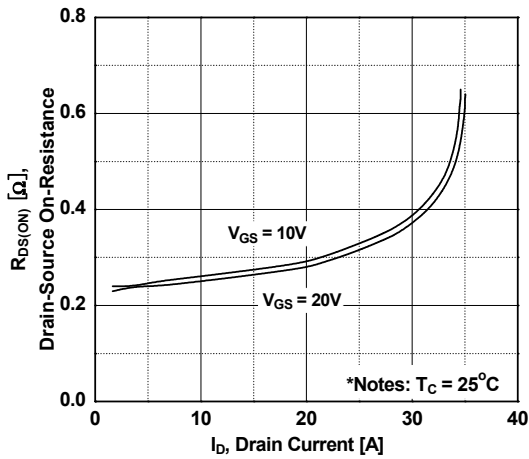

Figure 4. Body Diode Forward Voltage Variation vs. Source Current and Temperature

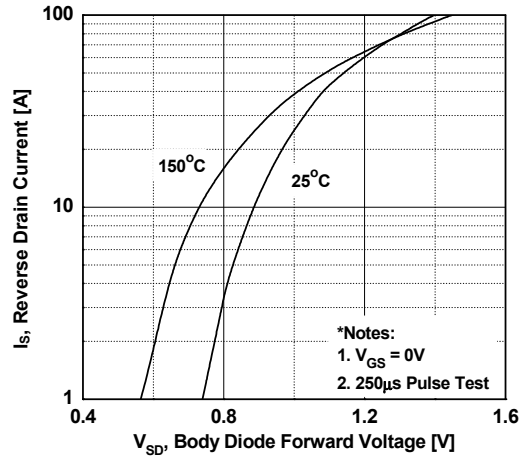

Figure 5. Capacitance Characteristics

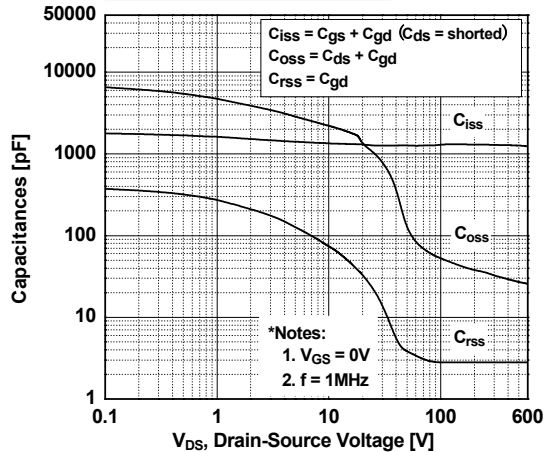
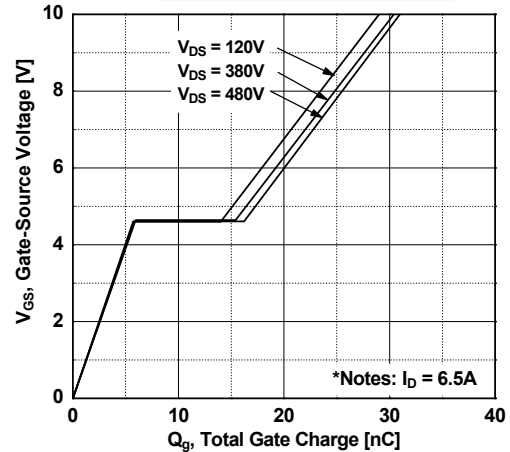

Figure 6. Gate Charge Characteristics



Typical Performance Characteristics (Continued)

Figure 7. Breakdown Voltage Variation vs. Temperature

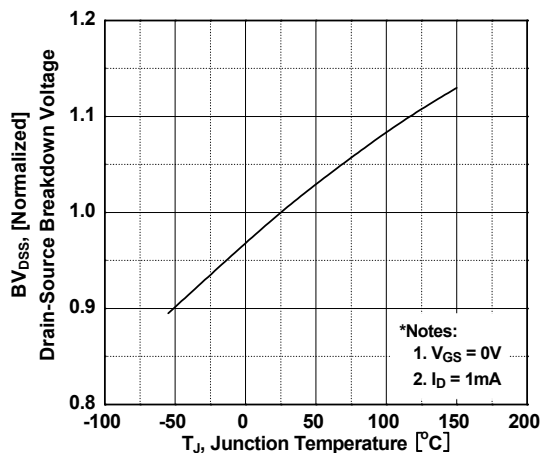

Figure 8. On-Resistance Variation vs. Temperature

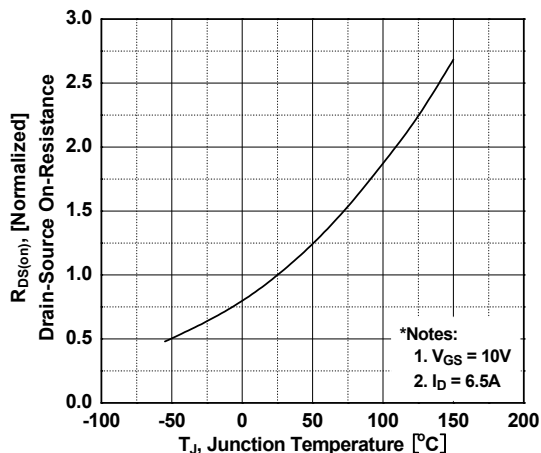

Figure 9. Maximum Safe Operating Area - FCP13N60N

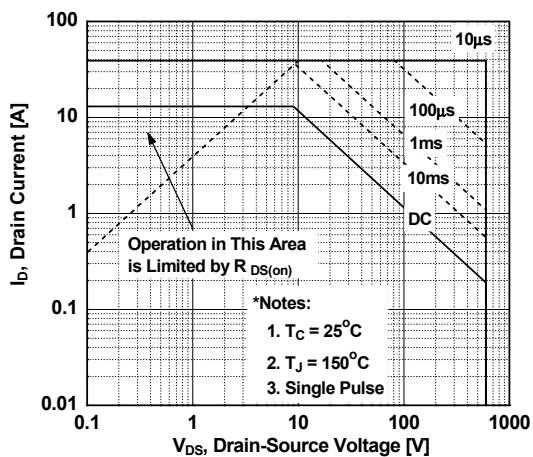

Figure 10. Maximum Safe Operating Area - FCPF13N60NT

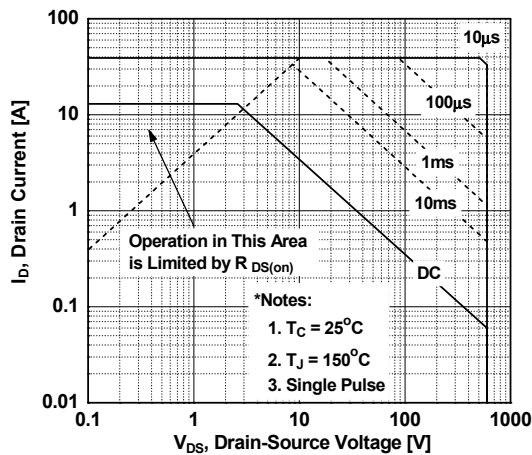
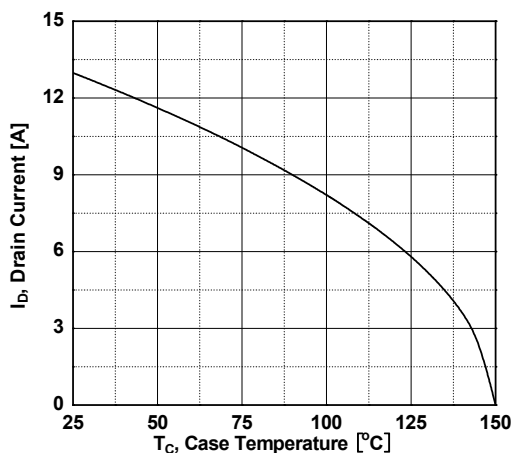

Figure 11. Maximum Drain Current vs. Case Temperature



Typical Performance Characteristics (Continued)

Figure 12. Transient Thermal Response Curve - FCP13N60N

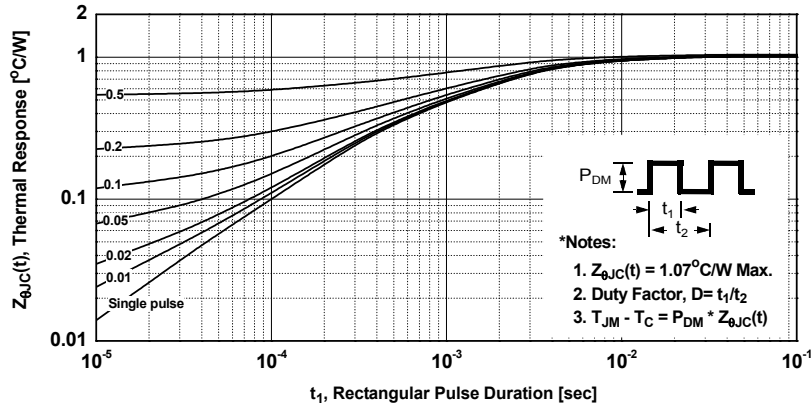
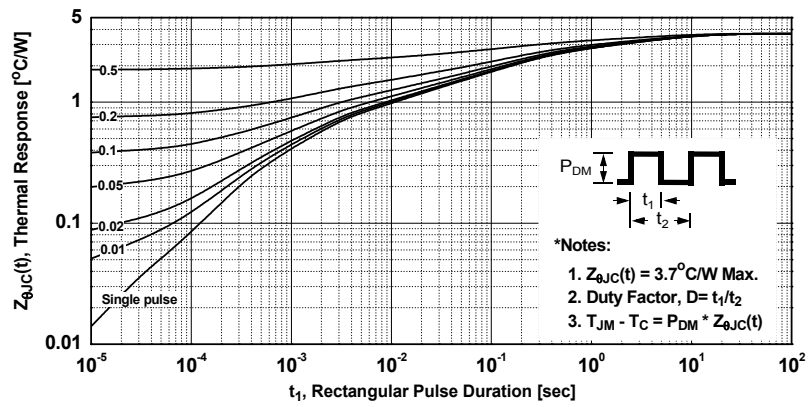

Figure 13. Transient Thermal Response Curve - FCPF13N60NT



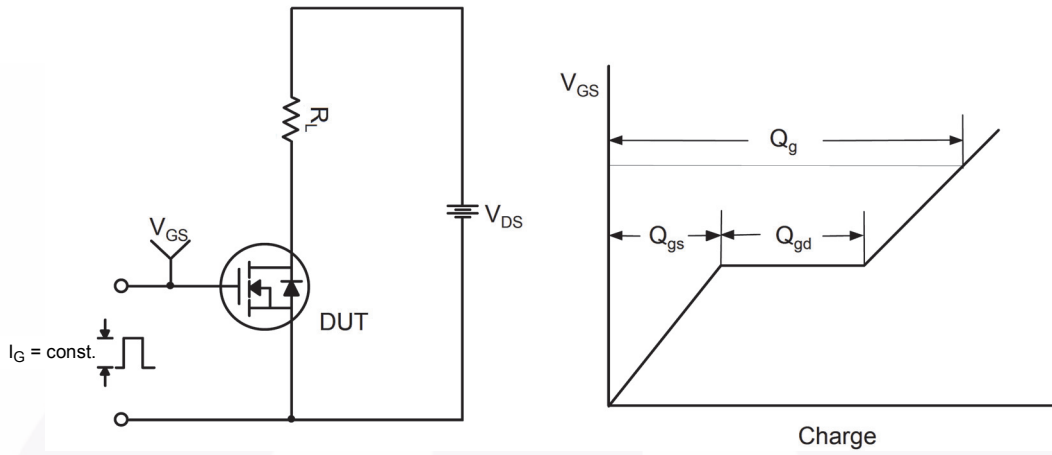

Figure 14. Gate Charge Test Circuit & Waveform



Figure 15. Resistive Switching Test Circuit & Waveforms



Figure 16. Unclamped Inductive Switching Test Circuit & Waveforms

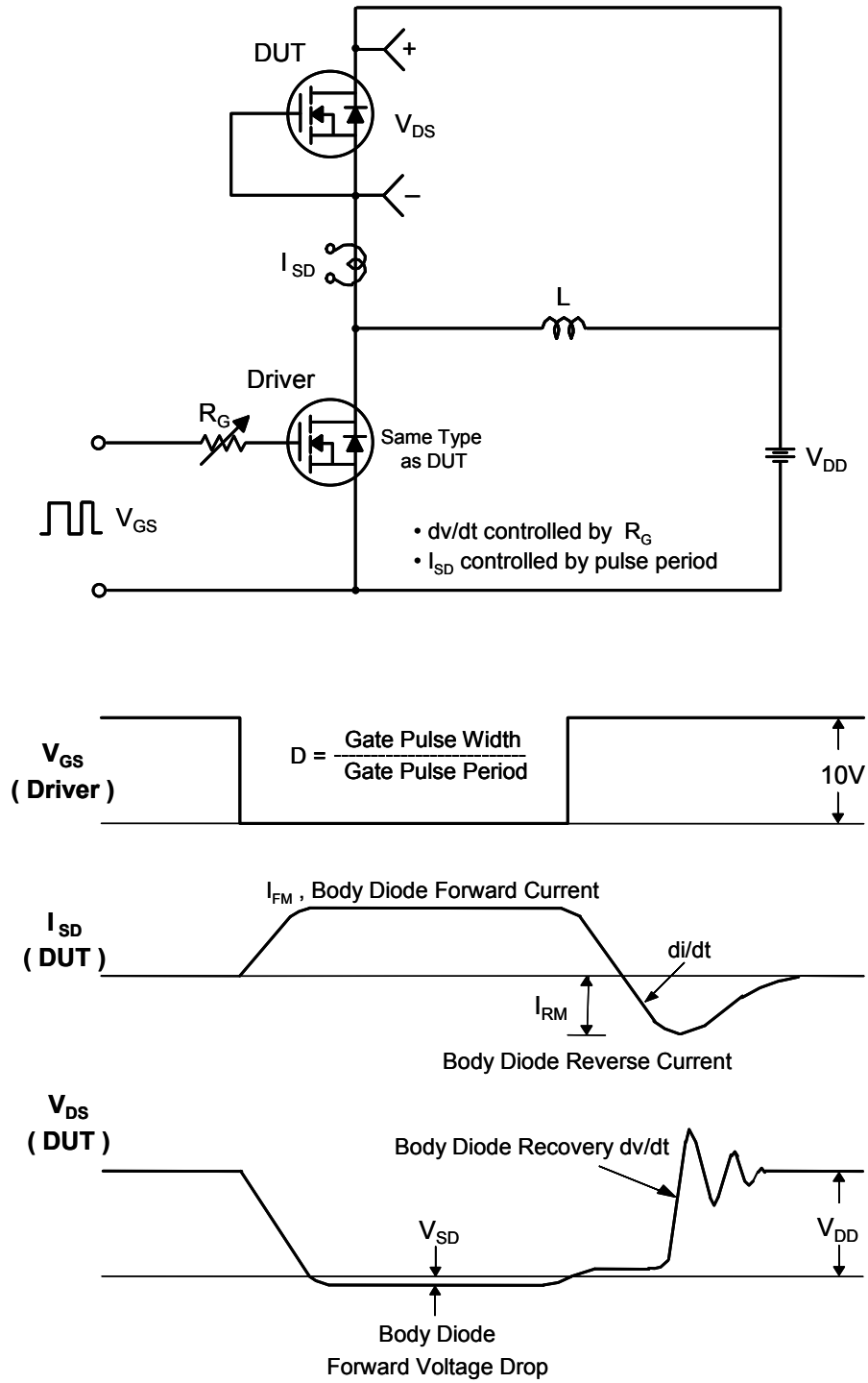

Figure 17. Peak Diode Recovery dv/dt Test Circuit & Waveforms

Mechanical Dimensions

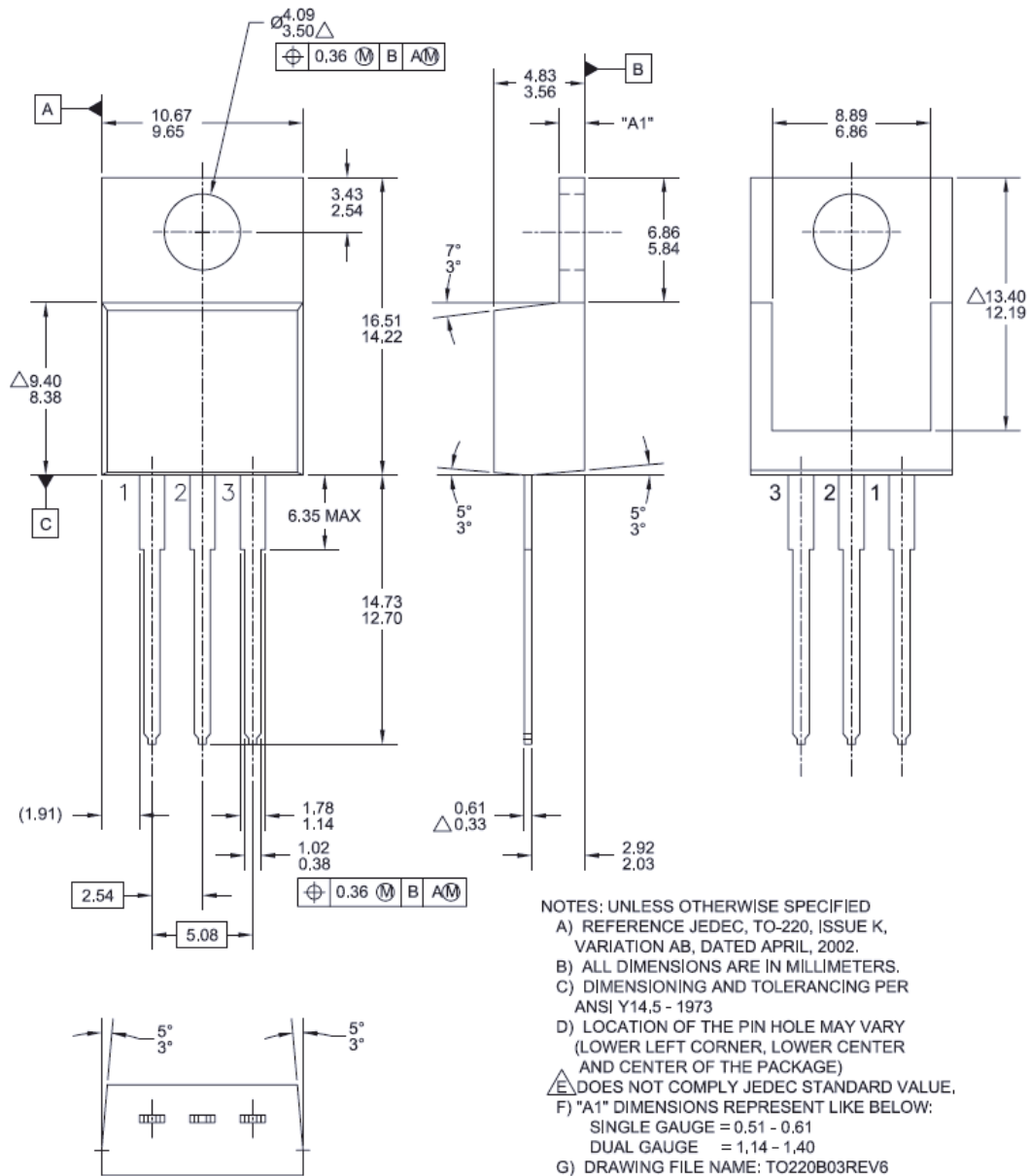

Figure 18. TO-220, Molded, 3-Lead, Jedec Variation AB

Package drawings are provided as a service to customers considering Fairchild components. Drawings may change in any manner without notice. Please note the revision and/or date on the drawing and contact a Fairchild Semiconductor representative to verify or obtain the most recent revision. Package specifications do not expand the terms of Fairchild's worldwide terms and conditions, specifically the warranty therein, which covers Fairchild products.

Always visit Fairchild Semiconductor's online packaging area for the most recent package drawings:

http://www.fairchildsemi.com/package/packageDetails.html?id=PN_TT220-003

ON Semiconductor and  are trademarks of Semiconductor Components Industries, LLC dba ON Semiconductor or its subsidiaries in the United States and/or other countries. ON Semiconductor owns the rights to a number of patents, trademarks, copyrights, trade secrets, and other intellectual property. A listing of ON Semiconductor's product/patent coverage may be accessed at www.onsemi.com/site/pdf/Patent-Marking.pdf. ON Semiconductor reserves the right to make changes without further notice to any products herein. ON Semiconductor makes no warranty, representation or guarantee regarding the suitability of its products for any particular purpose, nor does ON Semiconductor assume any liability arising out of the application or use of any product or circuit, and specifically disclaims any and all liability, including without limitation special, consequential or incidental damages. Buyer is responsible for its products and applications using ON Semiconductor products, including compliance with all laws, regulations and safety requirements or standards, regardless of any support or applications information provided by ON Semiconductor. "Typical" parameters which may be provided in ON Semiconductor data sheets and/or specifications can and do vary in different applications and actual performance may vary over time. All operating parameters, including "Typicals" must be validated for each customer application by customer's technical experts. ON Semiconductor does not convey any license under its patent rights nor the rights of others. ON Semiconductor products are not designed, intended, or authorized for use as a critical component in life support systems or any FDA Class 3 medical devices or medical devices with a same or similar classification in a foreign jurisdiction or any devices intended for implantation in the human body. Should Buyer purchase or use ON Semiconductor products for any such unintended or unauthorized application, Buyer shall indemnify and hold ON Semiconductor and its officers, employees, subsidiaries, affiliates, and distributors harmless against all claims, costs, damages, and expenses, and reasonable attorney fees arising out of, directly or indirectly, any claim of personal injury or death associated with such unintended or unauthorized use, even if such claim alleges that ON Semiconductor was negligent regarding the design or manufacture of the part. ON Semiconductor is an Equal Opportunity/Affirmative Action Employer. This literature is subject to all applicable copyright laws and is not for resale in any manner.

PUBLICATION ORDERING INFORMATION

LITERATURE FULFILLMENT:

Literature Distribution Center for ON Semiconductor
19521 E. 32nd Pkwy, Aurora, Colorado 80011 USA
Phone: 303-675-2175 or 800-344-3860 Toll Free USA/Canada
Fax: 303-675-2176 or 800-344-3867 Toll Free USA/Canada
Email: orderlit@onsemi.com

N. American Technical Support: 800-282-9855 Toll Free
USA/Canada
Europe, Middle East and Africa Technical Support:
Phone: 421 33 790 2910
Japan Customer Focus Center
Phone: 81-3-5817-1050

ON Semiconductor Website: www.onsemi.com
Order Literature: <http://www.onsemi.com/orderlit>
For additional information, please contact your local
Sales Representative