

PLEASE CHECK WWW.MOLEX.COM FOR LATEST PART INFORMATION

Part Number: [0734120502](#)
Status: **Active**
Overview: [RF/Microwave Products](#)
Description: MCRF-to-MCRF, 1.32mm Cable Diameter, Length 110.00mm, 50 Ohms

Documents:

[Drawing \(PDF\)](#) [RoHS Certificate of Compliance \(PDF\)](#)

General

Product Family	Cable Assemblies
Series	73412
Assembly Configuration	Dual Ended Connectors
Connector to Connector	MCRF-to-MCRF
Overview	RF/Microwave Products
Product Name	MCRF, RF
UPC	822348683109

Physical

Cable Length	110.00mm
Circuits (Loaded)	0
Gender	Plug/Plug
Material - Metal	Phosphor Bronze
Material - Plating Mating	Gold
Net Weight	0.530/g
Packaging Type	Bag
Single Ended	No
Wire/Cable Type	Coaxial

Electrical

Impedance	50Ω
-----------	-----

Solder Process Data

Lead-freeProcess Capability	N/A
-----------------------------	-----

Material Info

Reference - Drawing Numbers

Sales Drawing	SD-73118-025, SD-73412-050
---------------	----------------------------

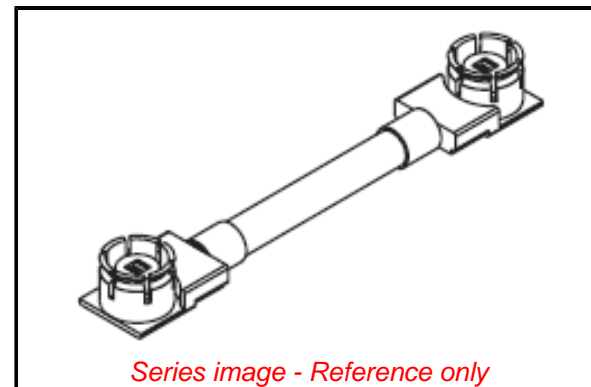

Series image - Reference only

EU ELV

Not Relevant

EU RoHS

Compliant

REACH SVHC

Not Contained Per

-ED/01/2017 (12

January 2017)

Halogen-Free

Status

Low-Halogen

Need more information on product environmental compliance?

Email productcompliance@molex.com

Please visit the [Contact Us](#) section for any non-product compliance questions.

China ROHS

ELV

RoHS Phthalates

Green Image

Not Relevant

Not Contained

Search Parts in this Series

[73412 Series](#)