

PLEASE CHECK WWW.MOLEX.COM FOR LATEST PART INFORMATION

Part Number: **0190020016**
Status: **Active**
Overview: Standard Quick-Disconnect Terminals
Description: Avikrimp™ Fully Insulated Quick Disconnect, Female, for 18-22 AWG Wire, Box

Documents:

3D Model	Product Specification PS-19902-013-001 (PDF)
Drawing (PDF)	Product Specification PS-19902-014-001 (PDF)
Product Specification PS-19902-011-001 (PDF)	RoHS Certificate of Compliance (PDF)

Agency Certification

CSA	LR18689
UL	E79133

General

Product Family	Quick Disconnects
Series	<u>19002</u>
Crimp Quality Equipment	Yes
Insulated	Fully
Overview	<u>Standard Quick-Disconnect Terminals</u>
Product Name	Avikrimp™
Type	Quick Disconnect
UPC	800753027152

Physical

Barrel Type	Closed
Color - Resin	Red
Flammability	94V-2
Gender	Female
Glow-Wire Compliant	Yes
Insulation	Nylon (PA)
Lock to Mating Part	None
Material - Metal	Brass
Material - Plating Mating	Tin
Material - Plating Termination	Tin
Net Weight	0.662/g
Orientation	Straight
Packaging Type	Bag
Plating min - Mating	4.064µm
Plating min - Termination	4.064µm
Polarized to Mating Part	No
Tab Thickness	0.81mm
Tab Width	2.79mm
Temperature Range - Operating	-65°C to +105°C
Termination Interface: Style	Crimp or Compression
Wire Insulation Diameter	3.17mm max.
Wire Size AWG	18, 20, 22

Electrical

Voltage - Maximum	300V
-------------------	------

Solder Process Data

Lead-free Process Capability	N/A
------------------------------	-----

Material Info

Engineering Number	AA-5279
--------------------	---------

Reference - Drawing Numbers

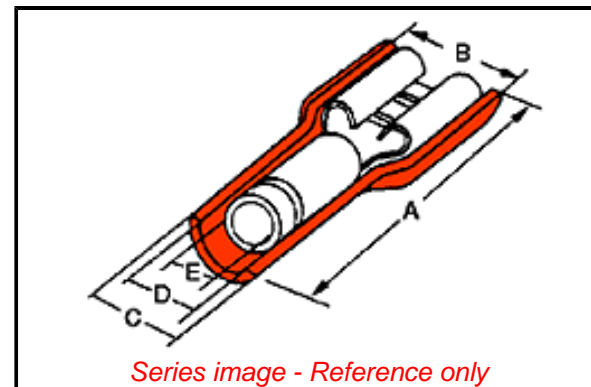

EU ELV

Not Relevant

EU RoHS

Compliant

REACH SVHC

Not Contained Per
-ED/01/2017 (12
January 2017)

Halogen-Free

Status

Low-Halogen

Need more information on product environmental compliance?

Email productcompliance@molex.com
Please visit the [Contact Us](#) section for any non-product compliance questions.

China ROHS

ELV

RoHS Phthalates

Green Image

Not Relevant

Not Contained

Search Parts in this Series

19002 Series

Product Specification

Sales Drawing

PS-19902-011-001, PS-19902-013-001,
PS-19902-014-001
SD-19002-003

This document was generated on 03/17/2017

PLEASE CHECK WWW.MOLEX.COM FOR LATEST PART INFORMATION