

# XT230A1FBL2

capacitive sensor - XT1 - cylindrical M30 - plastic - Sn 15 mm - cable 2 m



## Main

Range of product	OsiSense XT
Sensor type	Capacitive proximity sensor
Product specific application	Detection of insulated or conductive materials
Sensor name	XT2
Sensor design	Cylindrical M30
Size	74.5 mm
Body type	Fixed
Detector flush mounting acceptance	Non flush mountable
Material	Plastic
Enclosure material	Plastic
Type of output signal	Discrete
Wiring technique	2-wire
[Sn] nominal sensing distance	15 mm
Discrete output function	1 NC
Output circuit type	AC
Electrical connection	Cable
Cable length	2 m
[Us] rated supply voltage	24...240 V AC 50...60 Hz
Delay response	< 30 ms
IP degree of protection	IP67 double insulation conforming to IEC 60529

## Buy online

### Complementary

ISO thread	M30 x 1.5
Detection face	Frontal
[Sa] assured operating distance	0...11 mm
Adjustment zone	0...17 mm
Differential travel	< 1...20 % Sr
Repeat accuracy	< 5 % Sr
Wire insulation material	PVC
Status LED	1 LED (yellow) for output state indication
Supply voltage limits	20...265 V AC
Switching frequency	<= 25 Hz
Voltage drop	< 10 V (closed)
Current consumption	< 4 mA
Delay first up	< 200 ms
Delay recovery	< 30 ms
Maximum switching current	300 mA
Marking	CE
Setting-up	Sensitivity by potentiometer
Threaded length	48.5 mm
Length	74.5 mm
Product weight	0.27 kg

The information provided in this documentation contains general descriptions and/or technical characteristics of the performance of the products contained herein. This documentation is not intended as a substitute for and is not to be used for determining suitability or reliability of these products for specific user applications. It is the duty of any such user or integrator to perform the appropriate and complete risk analysis, evaluation and testing of the products with respect to the relevant specific application or use thereof. Neither Schneider Electric Industries SAS nor any of its affiliates or subsidiaries shall be responsible or liable for misuse of the information contained herein.

## Environment

Standards	EN/IEC 60947-5-2
Product certifications	CULus
Ambient air temperature for operation	-10...60 °C
Vibration resistance	10 gn amplitude = 1 mm (10...55 Hz) conforming to IEC 60068-2-6
Shock resistance	30 gn (duration = 11 ms) conforming to IEC 60068-2-27
Resistance to electrostatic discharge	4 kV (contact) conforming to IEC 61000-4-2 8 kV (air) conforming to IEC 61000-4-2
Resistance to electromagnetic fields	3 V/m conforming to IEC 61000-4-3
Resistance to fast transients	2 kV conforming to IEC 61000-4-4

## Offer Sustainability

Sustainable offer status	Not Green Premium product
RoHS (date code: YYWW)	Compliant - since 0918 - Schneider Electric declaration of conformity <a href="#">Schneider Electric declaration of conformity</a>

## Contractual warranty

Warranty period	18 months
-----------------	-----------

Dimensions

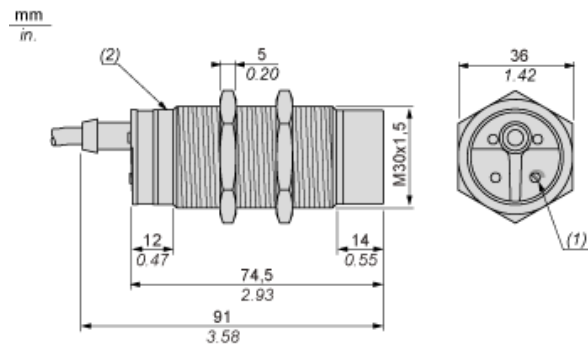

- (1) Adjustment potentiometer
- (2) LED

## Setting-up

### Minimum Mounting Distances (mm)

Side by side

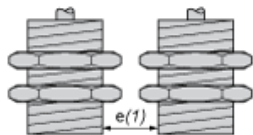

$e(1) \geq 60$

$\geq$

Face to face

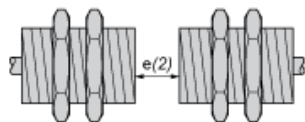

$e(2) \geq 90$

$\geq$

Facing a metal object

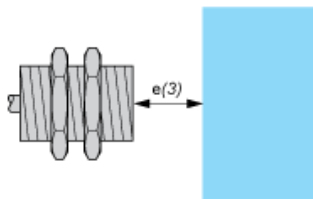

$e(3) \geq 45$

$\geq$

Mounted in support

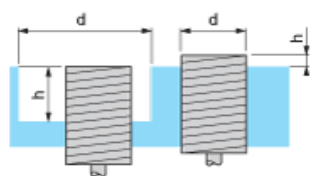

$d \geq 90$

$h \geq 30$

Fixing nut tightening torque: 8 N.m

## Adjustment

### Sensitivity Adjustment

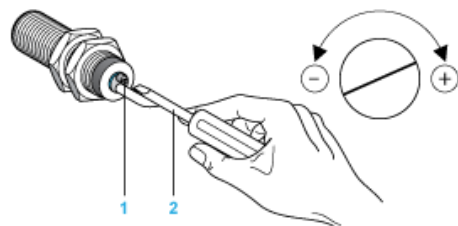

(1) Adjustment potentiometer

(2) Screwdriver (included with sensor)

---

## Wiring Diagram

---

### Pre-cabled

2-wire AC NC Output

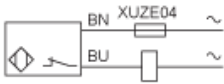

(BU) Blue  
(BN) Brown