

Limit switches

Osiswitch® Classic

Metal, conforming to CENELEC EN 50041, type XCK J

Fixed or plug-in body

Variable composition: standard bodies

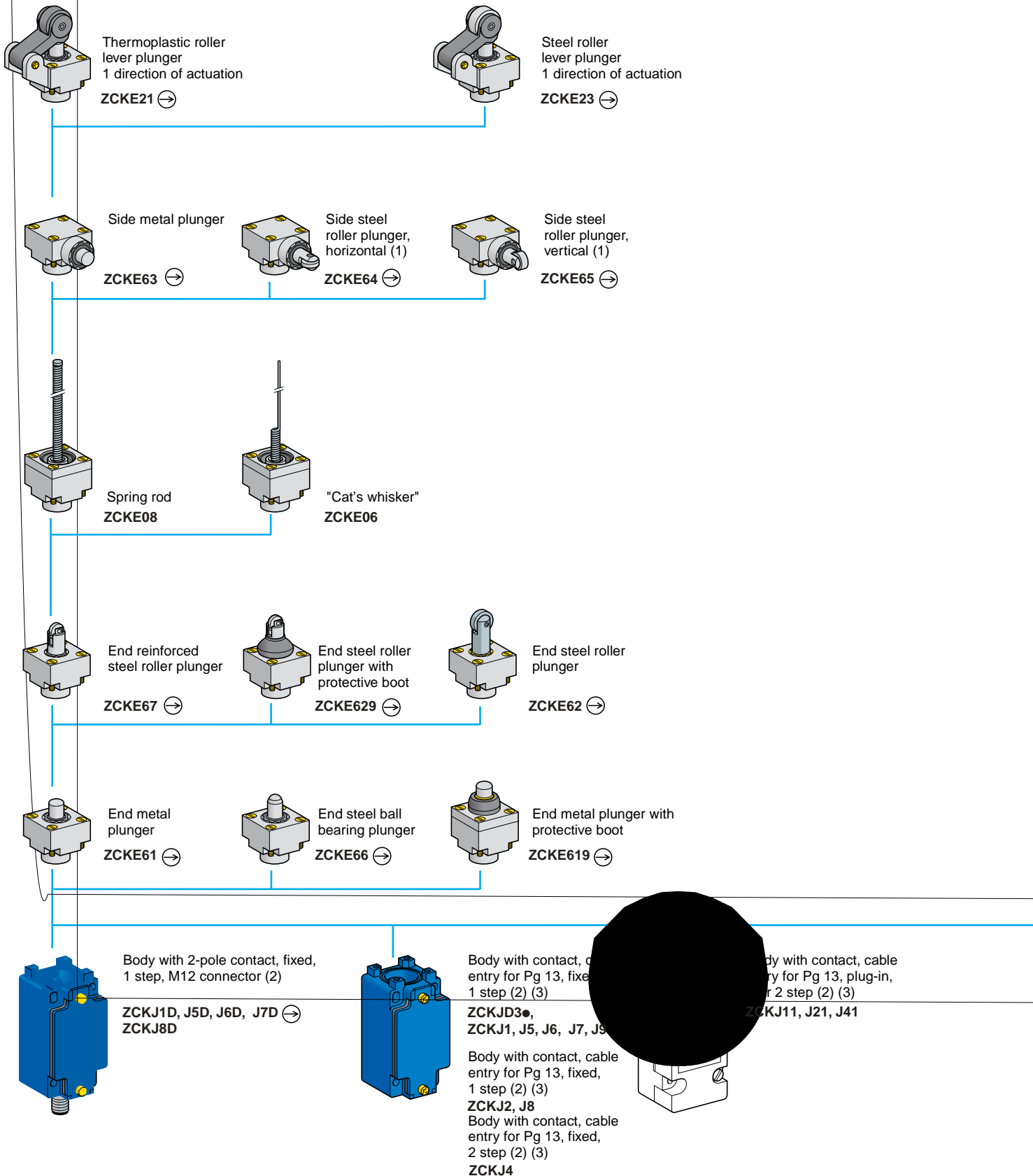

(1) Cannot be used on ZCKJ4 and ZCKJ41 bodies.

(2) For further details, see page 32402/4.

(3) For a cable entry tapped ISO M20 x 1.5, add the suffix **H29** to the reference. Example: ZCKJ1 becomes **ZCKJ1H29**.
For a cable entry tapped 1/2" NPT, add the suffix **H7** to the reference. Example: ZCKJ1 becomes **ZCKJ1H7**.

Limit switches

Osiswitch® Classic

Metal, conforming to CENELEC EN 50041, type XCK J

Fixed or plug-in body

Variable composition: standard bodies

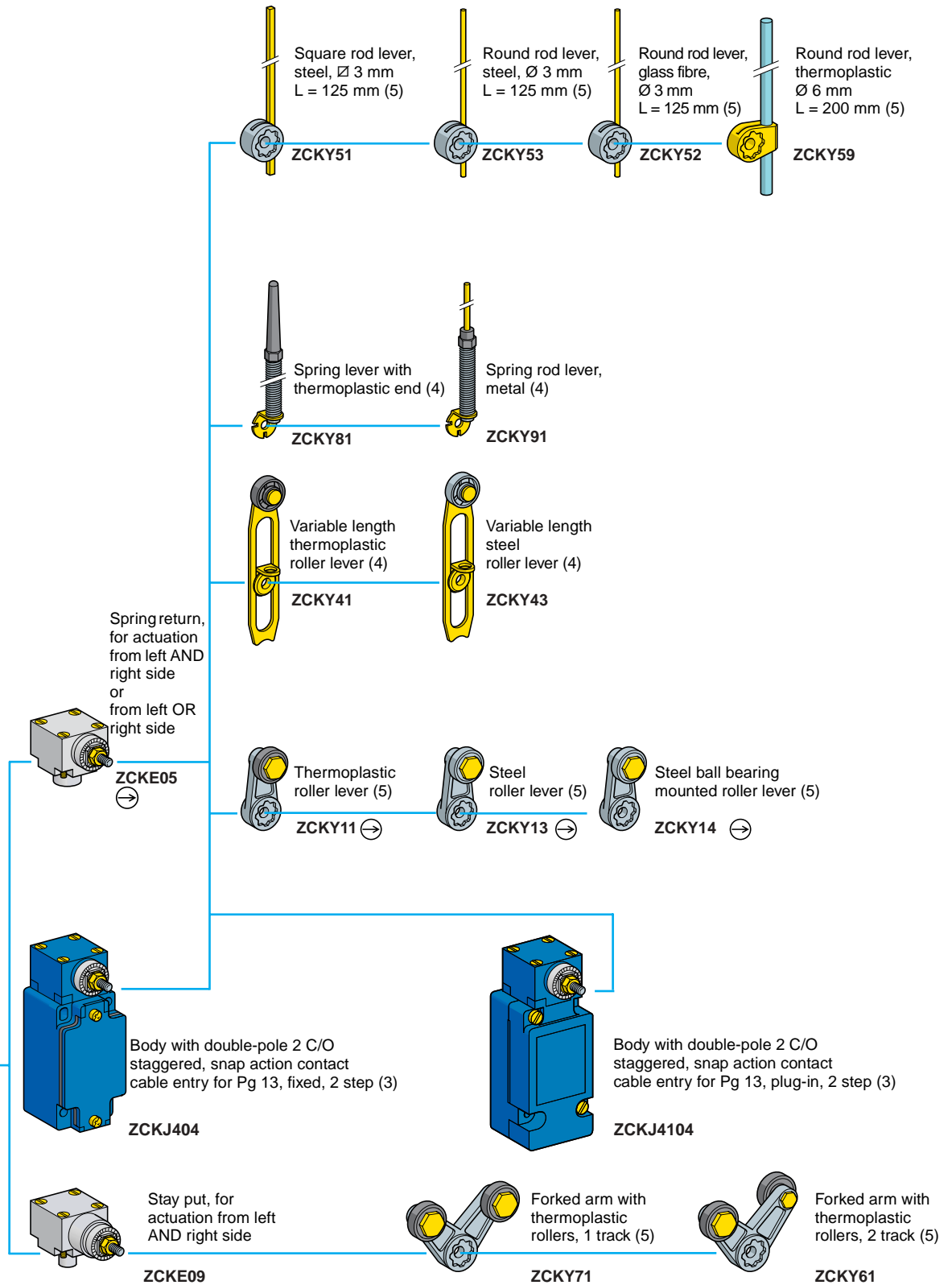

⊕: head assuring positive opening operation.

(4) Adjustable throughout 360° in 5° steps, or in 90° steps by reversing the notched washer.

(5) Adjustable throughout 360° in 5° steps, or in 45° steps by reversing the lever mounting.

Limit switches

Osiswitch® Classic

Metal, conforming to CENELEC EN 50041, type XCK J

Fixed body or plug-in body

Adaptable sub-assemblies: standard bodies

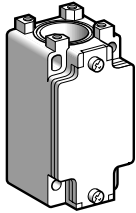

ZCK J0

Fixed bodies with 2-pole contact

Type	With contact block	Scheme	Positive operation (1)	Cable entry	Reference	Weight kg
1 step	N/C + N/O snap action (XE2S P2151)		⊖	Pg 13	ZCK J1	0.310
				ISO M20 x 1.5	ZCK J1H29	0.310
				1/2" NPT	ZCK J1H7	0.310
	2 C/O simultaneous, snap action (XES P2021)		-	Pg 13	ZCK J2	0.310
				ISO M20 x 1.5	ZCK J2H29	0.310
				1/2" NPT	ZCK J2H7	0.310
	N/C + N/O break before make, slow break (XE2N P2151)		⊖	Pg 13	ZCK J5	0.310
				ISO M20 x 1.5	ZCK J5H29	0.310
				1/2" NPT	ZCK J5H7	0.310
	N/O + N/C make before break, slow break (XE2N P2161)		⊕	Pg 13	ZCK J6	0.310
				ISO M20 x 1.5	ZCK J6H29	0.310
				1/2" NPT	ZCK J6H7	0.310
N/C + N/C simultaneous, slow break (XE2N P2141)		⊖	Pg 13	ZCK J7	0.310	
			ISO M20 x 1.5	ZCK J7H29	0.310	
			1/2" NPT	ZCK J7H7	0.310	
N/O + N/O simultaneous, slow break (XE2N P2131)		-	Pg 13	ZCK J8	0.310	
			ISO M20 x 1.5	ZCK J8H29	0.310	
			1/2" NPT	ZCK J8H7	0.310	
N/C + N/C snap action (XE2S P2141)		⊖	Pg 13	ZCK J9	0.310	
			ISO M20 x 1.5	ZCK J9H29	0.310	
			1/2" NPT	ZCK J9H7	0.310	
2 step	2 C/O staggered, snap action (XES P2031)		-	Pg 13	ZCK J4	0.310
				ISO M20 x 1.5	ZCK J4H29	0.310
				1/2" NPT	ZCK J4H7	0.310

Fixed bodies with 3-pole contact

-	N/C + N/O + N/O snap action (XE3S P2151)		⊕	Pg 13	ZCK JD31	0.310
				ISO M20 x 1.5	ZCK JD31H29	0.310
				1/2" NPT	ZCK JD31H7	0.310
				N/C + N/C + N/O snap action (XE3S P2141)		⊖
ISO M20 x 1.5	ZCK JD39H29	0.310				
1/2" NPT	ZCK JD39H7	0.310				
N/C + N/C + N/O break before make, slow break (XE3N P2141)		⊕	Pg 13			
			ISO M20 x 1.5	ZCK JD37H29	0.310	
			1/2" NPT	ZCK JD37H7	0.310	
			N/C + N/O + N/O break before make, slow break (XE3N P2151)		⊕	Pg 13
ISO M20 x 1.5	ZCK JD35H29	0.310				
1/2" NPT	ZCK JD35H7	0.310				

(1) ⊕: N/C contact with positive opening operation.

Limit switches

Osiswitch® Classic

Metal, conforming to CENELEC EN 50041, type XCK J

Fixed or plug-in body

Adaptable sub-assemblies: standard bodies

Plug-in bodies with contact

Type	With contact block	Scheme	Positive operation (1) entry	Cable	Reference	Weight kg
1 step	Single-pole C/O snap action		-	Pg 13	ZCK J11	0.300
				ISO M20 x 1.5	ZCK J11H29	0.300
				1/2" NPT	ZCK J11H7	0.300
	Double-pole 2 C/O simultaneous, snap action		-	Pg 13	ZCK J21	0.300
				ISO M20 x 1.5	ZCK J21H29	0.300
				1/2" NPT	ZCK J21H7	0.300
2 step	Double-pole 2 C/O staggered, snap action		-	Pg 13	ZCK J41	0.300
				ISO M20 x 1.5	ZCK J41H29	0.300
				1/2" NPT	ZCK J41H7	0.300

Bodies with contact and rotary head (without operating lever)

Fixed body						
2 step	Double-pole 2 C/O staggered, snap action		-	Pg 13	ZCK J	0.455
				ISO M20 x 1.5	ZCK JH29	0.455
				1/2" NPT	ZCK JH7	0.455
Plug-in body						
2 step	Double-pole 2 C/O staggered, snap action		-	Pg 13	ZCK J4104	0.465
				ISO M20 x 1.5	ZCK J4104H29	0.465
				1/2" NPT	ZCK J4104H7	0.465

(1) : N/C contact with positive opening operation.

Limit switches

Osiswitch® Classic
 Metal, conforming to CENELEC EN 50041, type XCK J
 Fixed or plug-in body
 Adaptable sub-assemblies: bodies with indicator light module

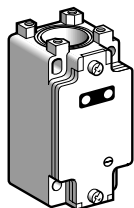

ZCK J●●●

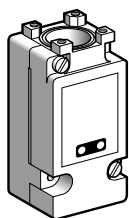

ZCK J1●●●

Fixed bodies with 2-pole contact

Type	With contact block	Scheme	Positive operation (1) entry	Cable entry	Reference	Weight kg
With module comprising 1 LED, ≍ 24 V						
1 step	N/C + N/O snap action (XE2S P2151)		⊕	Pg 13	ZCK J120	0.320
	N/C + N/O break before make, slow break (XE2N P2151)		⊕	Pg 13	ZCK J520	0.320
With module comprising 2 LEDs, ≍ 24 V						
1 step	N/C + N/O snap action (XE2S P2151)		⊕	Pg 13 ISO M20 x 1.5	ZCK J121 ZCK J121H29	0.320 0.320
	N/C + N/O break before make, slow break (XE2N P2151)		⊕	Pg 13 ISO M20 x 1.5	ZCK J521 ZCK J521H29	0.320 0.320
With module comprising 2 neon indicator lights, ~ 110/120 V						
1 step	N/C + N/O snap action (XE2S P2151)		⊕	Pg 13 ISO M20 x 1.5	ZCK J133 ZCK J133H29	0.320 0.320
	N/C + N/O break before make, slow break (XE2N P2151)		⊕	Pg 13 ISO M20 x 1.5	ZCK J533 ZCK J533H29	0.320 0.320
With module comprising 2 neon indicator lights, ~ 220/240 V						
1 step	N/C + N/O snap action (XE2S P2151)		⊕	Pg 13 ISO M20 x 1.5	ZCK J134 ZCK J134H29	0.320 0.320
	N/C + N/O break before make, slow break (XE2N P2151)		⊕	Pg 13 ISO M20 x 1.5	ZCK J534 ZCK J534H29	0.320 0.320

Plug-in bodies with single-pole contact

With module comprising 2 LEDs, ≍ 24 V						
1 step	C/O snap action		-	Pg 13 ISO M20 x 1.5	ZCK J1121 ZCK J1121H29	0.340 0.340
With module comprising 2 neon indicator lights, ~ 110/120 V						
1 step	C/O snap action		-	Pg 13 ISO M20 x 1.5	ZCK J1133 ZCK J1133H29	0.340 0.340
With module comprising 2 neon indicator lights, ~ 220/240 V						
1 step	C/O snap action		-	Pg 13 ISO M20 x 1.5	ZCK J1134 ZCK J1134H29	0.340 0.340

(1) ⊕ : N/C contact with positive opening operation.

Indicator light module characteristics

Type of indicator	1 LED or 2 LEDs	2 neon lights	
Rated insulation voltage	≍ 50 V, to IEC 60947-1	~ 250V, to IEC 60947-1	
Current consumption	7 mA per LED	2.5 mA per neon	5 mA per neon
Rated operational voltage	≍ 24 V	~ 110/120 V	~ 220/240 V
Voltage limits	≍ 20...30 V (including ripple)	~ 95...130 V	~ 190...260 V
Service life	100,000 hours	20,000 hours	20,000 hours
Reverse polarity protection	Yes	-	

Limit switches

Osiswitch® Classic

Metal, conforming to CENELEC EN 50041, type XCK J

Fixed or plug-in body

Adaptable sub-assemblies: bodies with M12 connector

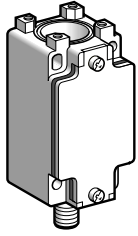

ZCK J•D

Fixed bodies with 2-pole contact

Type	With contact block	Scheme	Positive operation (1)	Reference	Weight kg
1 step	N/C + N/O snap action (XE2S P2151)		(2)	ZCK J1D	0.320
	N/C + N/O break before make, slow break (XE2N P2151)		(2)	ZCK J5D	0.320
	N/O + N/C make before break, slow break (XE2N P2161)		(2)	ZCK J6D	0.320
	N/C + N/C simultaneous, slow break (XE2N P2141)		(2)	ZCK J7D	0.320
	N/O + N/O simultaneous, slow break (XE2N P2131)		—	ZCK J8D	0.320

(1) ⊖: N/C contact with positive opening operation.

(2) Although their design is identical to switches with cable entries, the switches incorporating an M12 5-pin connector cannot be marked with the ⊖ symbol according to the standard IEC 60947-5-1, Appendix K (the insulation voltage U_i of the connector must be greater than or equal to 250 V).

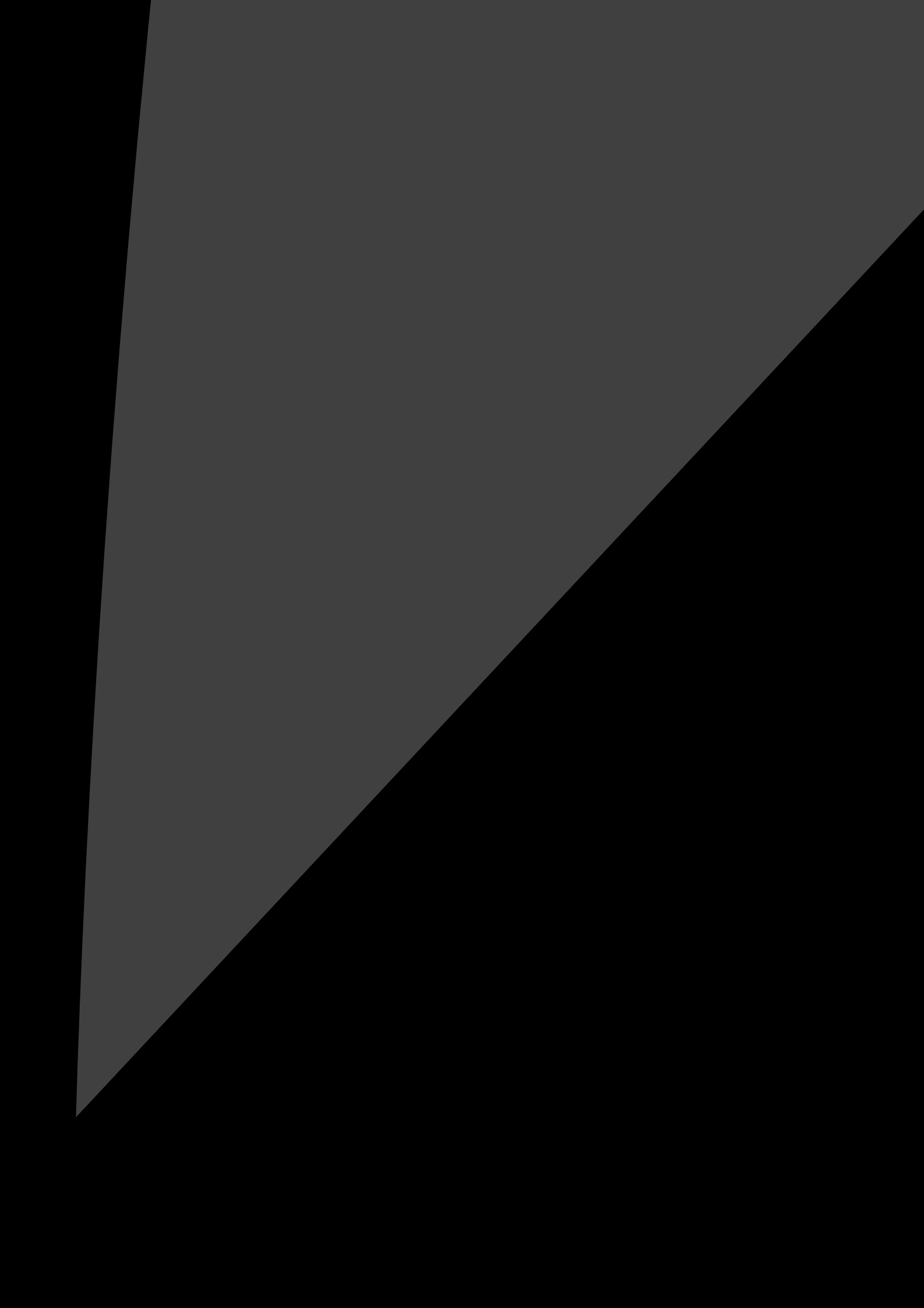

Limit switches

Osiswitch® Classic

Metal, conforming to CENELEC EN 50041, type XCK J

Fixed or plug-in body

Adaptable sub-assemblies: add-ons

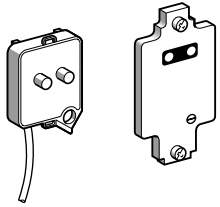

ZCK Z0●●

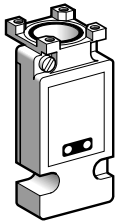

ZCK J01●●

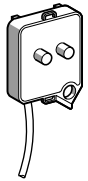

ZCK J90●

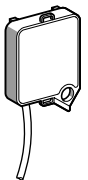

ZCK J82A

Covers + indicator light module

For use with	Number and type of indicators	Voltage	Reference	Weight kg
Fixed body	1 LED	≡ 24 V	ZCK Z020	0.060
	2 LEDs	≡ 24 V	ZCK Z021	0.060
	2 neon indicators	~ 110/120 V	ZCK Z033	0.060
		~ 220/240 V	ZCK Z034	0.060
Plug-in body	2 LEDs	≡ 24 V	ZCK J0121	0.200
	2 neon indicators	~ 110/120 V	ZCK J0133	0.200
		~ 220/240 V	ZCK J0134	0.200

Indicator light modules

For use with	Number and type of indicators	Voltage	Reference	Weight kg
Fixed body	1 LED	≡ 24 V	ZCK J902	0.030
	2 LEDs	≡ 24 V	ZCK J906	0.030
	2 neon indicators	~ 110/120 V	ZCK J903	0.030
		~ 220/240 V	ZCK J904	0.030

Module with resistor for machine diagnostics

For use with	Resistor value	Reference	Weight kg
Fixed body (ZCK J1 only)	15 kW, 1/4 W	ZCK J82A	0.030

Other versions Covers + indicator light module for other supply voltages. Please consult your Regional Sales Office.

Limit switches

Osiswitch® Classic

Metal, conforming to CENELEC EN 50041, type XCK J

Fixed or plug-in body

Adaptable sub-assemblies

Function diagrams (positive operation assured only if the associated sub-assemblies are ⊕)

Heads ZCK E61, E619, E66 with body

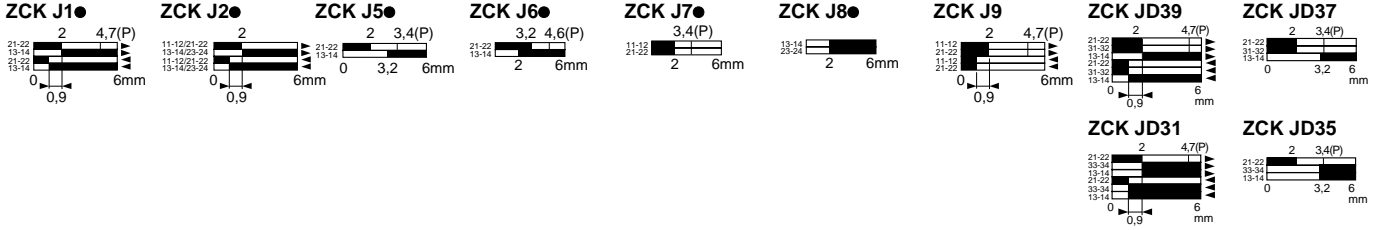

Head ZCK E63 with body



Heads ZCK E64, E65 with body

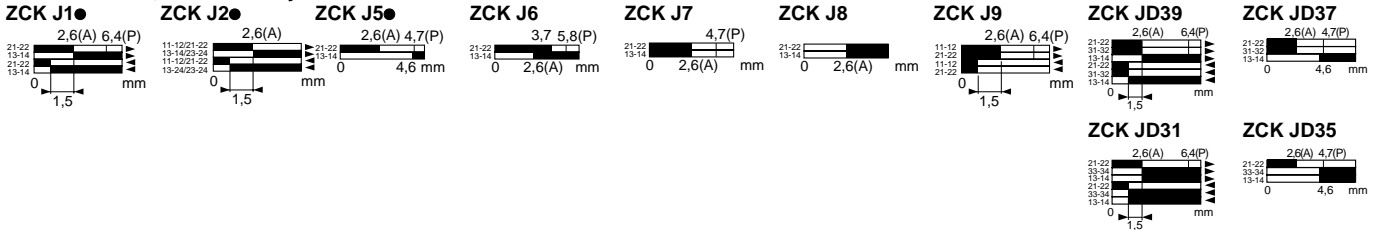

Heads ZCK E67, E629 with body

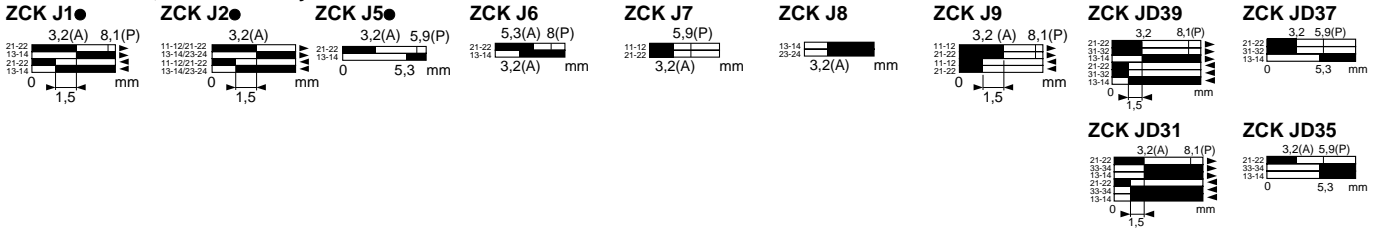

Heads ZCK E21, E23 with body

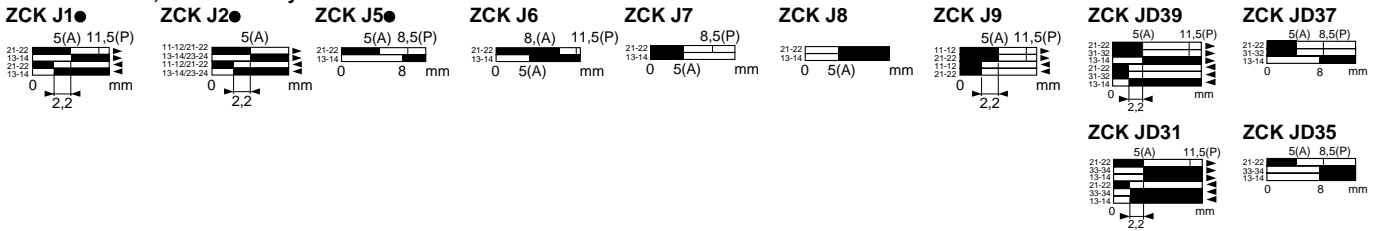

Heads ZCK E06, E08 with body

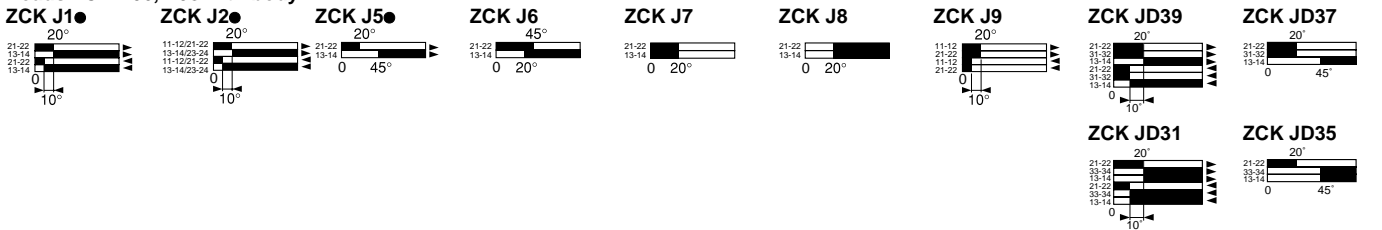

ZCK J4

Unactuated

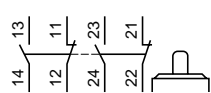

1st step

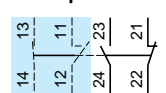

2nd step

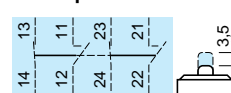

Contact operation

■ contact closed
□ contact open

(A) = cam displacement
(P) = positive opening point

Limit switches

Osiswitch® Classic

Metal, conforming to CENELEC EN 50041, type XCK J

Fixed or plug-in body

Adaptable sub-assemblies

Function diagrams (positive operation assured only if the associated sub-assemblies are ⊖)

Head ZCK E05 with body

ZCK J1●

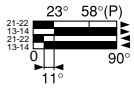

ZCK J2●

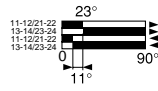

ZCK J5●

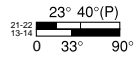

ZCK J6



ZCK J7

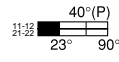

ZCK J8



ZCK J9

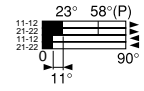

ZCK JD39

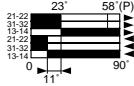

ZCK JD37

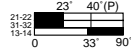

ZCK JD31

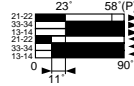

ZCK JD35

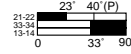

ZCK J4●

Unactuated

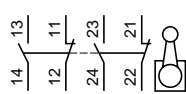

1st step, actuated from the left or right

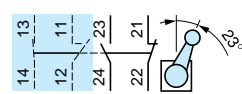

2nd step, actuated from the left or right

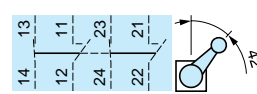

Head ZCK E09 with body

ZCK J1●

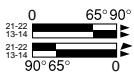

ZCK J2●

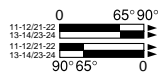

ZCK J404, J4104 (body with head)

Unactuated

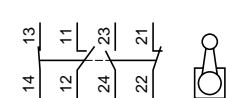

Actuated from the left

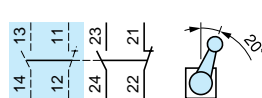

Actuated from the right

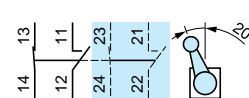

Contact operation

■ contact closed (P) = positive opening point
□ contact open

Wiring schemes

Indicator light modules

1 LED, ~ 24 V

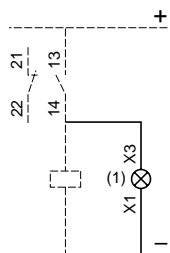

2 LEDs, ~ 24 V

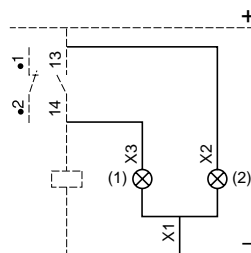

2 neon indicators, ~ 110/120 or 220/240 V

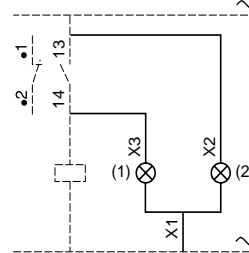

(1) Orange indicator
(2) Green indicator

Module with resistor

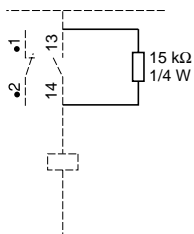

ZCK J●D

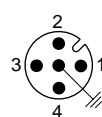

1 - 2 = N/C
3 - 4 = N/O
5 = GND
4 A / 24 V max.



Limit switches

Osiswitch® Classic

Metal, conforming to CENELEC EN 50041, type XCK J

Fixed or plug-in body

Adaptable sub-assemblies

Bodies

ZCK J1, J2, J5, J4, J2●, J3●, J6, J7, J8, J9

ZCK J1H29, J2H29, J5H29, J4H29, J2●H29, J3●H29, J6H29, J7H29, J8H29, J9H29

ZCK J1H7, J2H7, J5H7, J4H7, J2●H7, J3●H7, J6H7, J7H7, J8H7, J9H7

ZCK J11, J21, J41, J11●●

ZCK J11H29, J21H29, J41H29, J11●●H29

ZCK J11H7, J21H7, J41H7, J11●●H7

ZCK J1D, J5D, J6D, J7D, J8D

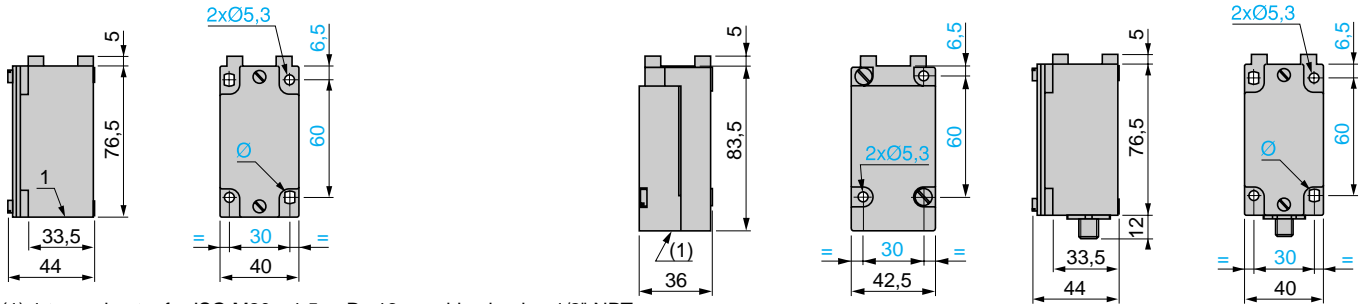

(1) 1 tapped entry for ISO M20 x 1.5 or Pg 13 or cable gland or 1/2" NPT.

Ø: 2 elongated holes Ø 5.3 x 7.3.

Bodies with rotary head mounted

ZCK J404, ZCK J404H29, ZCK J404H7

ZCK J4104, ZCK J4104H29, ZCK J4104H7

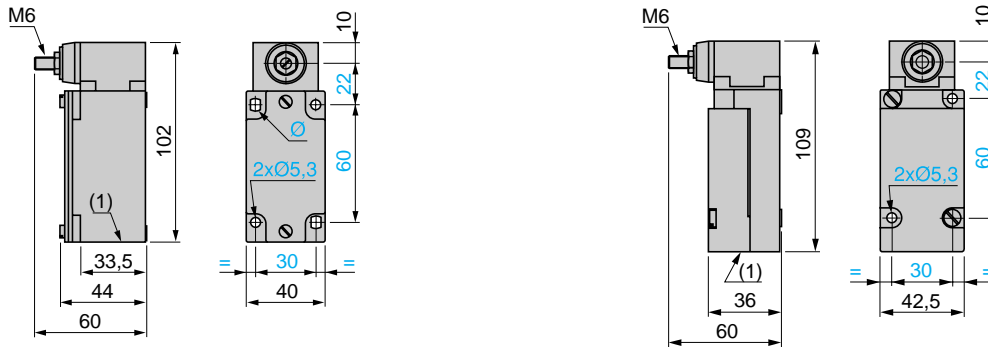

(1) 1 tapped entry for ISO M20 x 1.5 or Pg 13 cable gland or 1/2" NPT.

Ø: 2 elongated holes Ø 5.3 x 7.3.

Plunger heads

ZCK E61

ZCK E619

ZCK E63

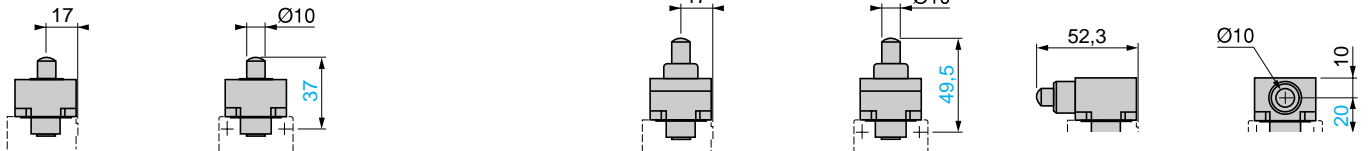

ZCK E64

ZCK E65

ZCK E66

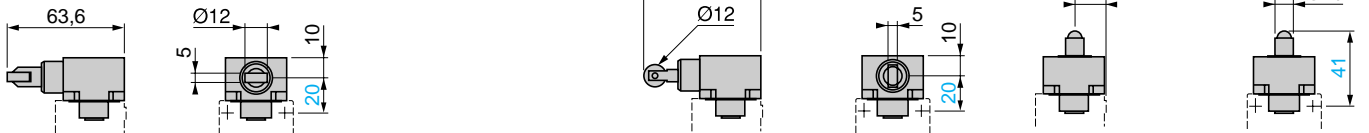

ZCK E62, ZCK E67

ZCK E629

ZCK E21, E23

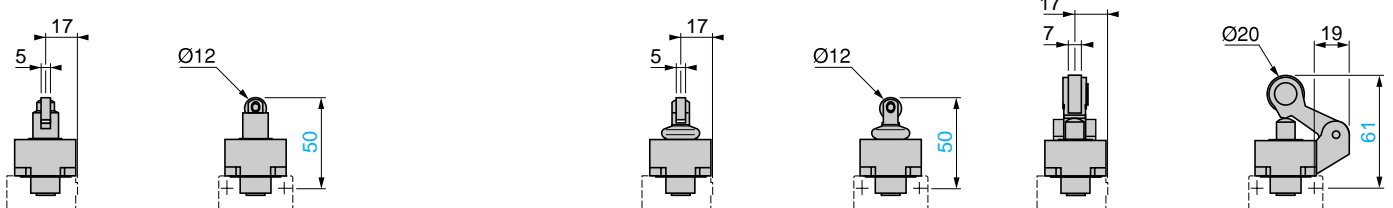

Limit switches

Osiswitch® Classic
 Metal, conforming to CENELEC EN 50041, type XCK J
 Fixed or plug-in body
 Adaptable sub-assemblies

Rotary head ZCK E05 with operating lever

ZCK Y11, Y13, Y14

ZCK Y41, Y43

ZCK Y51, Y52, Y53, Y59

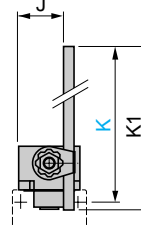
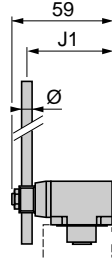
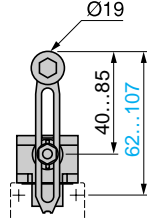
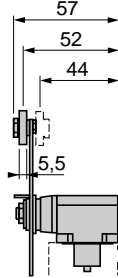
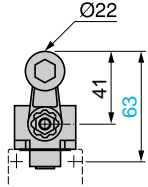
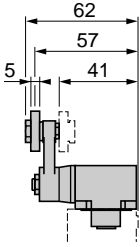

	J	J1	K	K1	Ø
			max.		
ZCK Y51	20	49	137	123	Ø3
ZCK Y52	20	49	137	125	Ø3
ZCK Y53	20	49	137	125	Ø3
ZCK Y59	26.2	48	212	200	Ø6

ZCK Y81

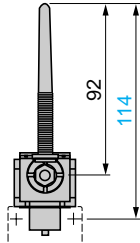
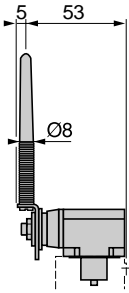

ZCK Y91

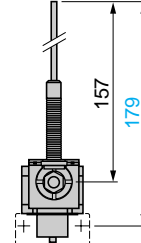
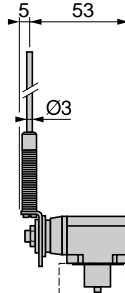

Note: operating lever spindle threaded M6

Rotary head ZCK E09 with operating lever

ZCK Y61

ZCK Y71

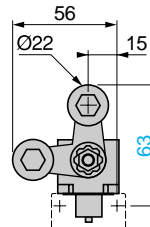
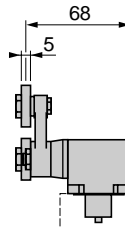
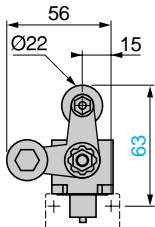
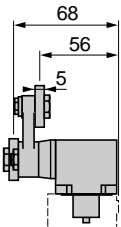

Note: operating lever spindle threaded M6

Multi-directional heads

ZCK E06

ZCK E08

