



SAW Components

SAW duplexer

Band III

Series/type:	B8088
Ordering code:	B39182B8088P810
Date:	August 05, 2013
Version:	2.4

© EPCOS AG 2015. Reproduction, publication and dissemination of this publication, enclosures hereto and the information contained therein without EPCOS' prior express consent is prohibited.

EPCOS AG is a TDK Group Company.

Data Sheet

Application

- Low-loss SAW duplexer for mobile telephone Band III systems
- Low insertion attenuation
- Low amplitude ripple
- Usable passband 75 MHz
- Single ended to balanced transformation in Antenna - Rx path
- Impedance transformation 50Ω to 100Ω in Antenna - Rx path
- high Tx - Rx isolation

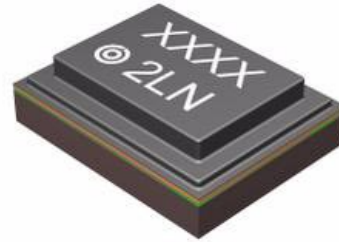
Features

- Package size 2.0 x 1.6
- Component height 0.45 mm max.
- RoHS compatible
- Approximate weight 0.006 g
- Package for **Surface Mount Technology (SMT)**
- Ni, gold-plated terminals
- **Electrostatic Sensitive Device (ESD)**
- **Moisture Sensitive Level 3**

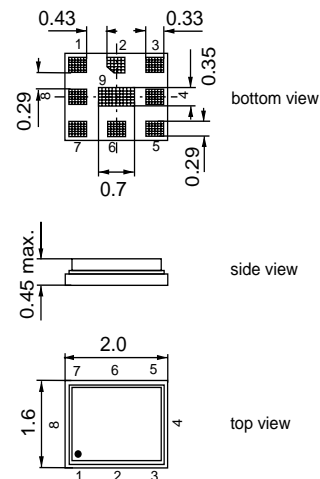
Pin configuration

- 1,8 RX Output (balanced)
- 3 TX Input (single ended)
- 6 Antenna
- 2, 4, 5 To be grounded
- 7, 9 To be grounded

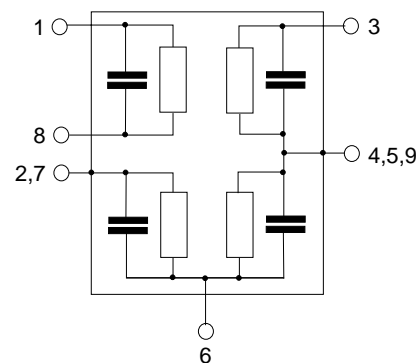

Data Sheet

Characteristics

Temperature range for specification:	T = -20 °C to +85 °C
ANT terminating impedance:	Z _{ANT} = 50 Ω 3.9nH.
RX terminating impedance:	Z _{RX} = 100 Ω (balanced) 12nH.
TX terminating impedance:	Z _{TX} = 50 Ω

Characteristics TX-ANT		min.	typ. @ 25°C	max.	
Center frequency	f _C	–	1747.5	–	MHz
Maximum insertion attenuation	α _{max}				
1714.0 ... 1781.0 MHz			2.0	3.0	dB
1710.0 ... 1785.0 MHz			2.5	4.0	dB
Amplitude ripple per 5MHz channel	Δα				
1710.0 ... 1785.0 MHz			0.55	1.3	dB
VSWR					
TX port 1710.0 ... 1785.0 MHz			1.5	2.0	
ANT port 1710.0 ... 1785.0 MHz			1.5	2.0	
Attenuation	α				
10.0 ... 1565.42 MHz		30	33		dB
207.5 ... 222.0 MHz		50	62		dB
470.0 ... 770.0 MHz		35	40		dB
1565.42 ... 1573.374MHz		40	46		dB
1573.374... 1577.466MHz		42	47		dB
1577.466... 1585.42 MHz		40	44		dB
1597.5515... 1605.886MHz		35	39		dB
1605.886... 1680.0 MHz		20	30		dB
1805.0 ... 1880.0 MHz		43	47		dB
1920.0 ... 1980.0 MHz		20	33		dB
2110.0 ... 2170.0 MHz		27	41		dB
2400.0 ... 2500.0 MHz		30	34		dB
2620.0 ... 2690.0 MHz		27	31		dB
3420.0 ... 3570.0 MHz		20	25		dB
5130.0 ... 5355.0 MHz		15	20		dB
5725.0 ... 5850.0 MHz		15	20		dB

Data Sheet

Characteristics

Temperature range for specification:	T = -20 °C to +85 °C
ANT terminating impedance:	Z _{ANT} = 50 Ω 3.9nH.
RX terminating impedance:	Z _{RX} = 100 Ω (balanced) 12nH.
TX terminating impedance:	Z _{TX} = 50 Ω

Characteristics ANT-RX		min.	typ. @ 25°C	max.	
Center frequency	f _C	-	1842.5	-	MHz
Maximum insertion attenuation	α _{max}				
1805.0 ... 1880.0 MHz			3.0	4.3	dB
Amplitude ripple per 5MHz channel	Δα				
1805.0 ... 1880.0 MHz			0.65	1.7	dB
Common mode rejection ratio					
1805.0 ... 1880.0 MHz		23 ¹⁾	25		dB
VSWR					
RX port 1805.0 ... 1880.0 MHz			1.6	2.0	
ANT port 1805.0 ... 1880.0 MHz			1.6	2.0	
Attenuation	α				
10.0 ... 1710.0 MHz		35	58		dB
1710.0 ... 1785.0 MHz		45	54		dB
1965.0 ... 2400.0 MHz		15	58		dB
2400.0 ... 2484.0 MHz		30	60		dB
2484.0 ... 5650.0 MHz		30	52		dB
IMD Product Level Limits²⁾	α				
at f _{TX} =1747.5MHz, f _{RX} =1842.5MHz					
Blocker 1 95.0 MHz			-115		dBm
Blocker 2 1652.5 MHz			-114		dBm
Blocker 3 3590.0 MHz			-110		dBm
Blocker 4 5337.5 MHz			-116		dBm

¹⁾ A combination of 10° phase balance and 1 dB amplitude balance corresponds to 19.6 dB CMRR

²⁾ IMD product level limits for power levels P_{TX}=21dBm (antenna port output power) and P_{Blocker}= -15dBm (antenna port input power)

Data Sheet

Characteristics

Temperature range for specification:	T = -20 °C to +85 °C
ANT terminating impedance:	Z _{ANT} = 50 Ω 3.9nH.
RX terminating impedance:	Z _{RX} = 100 Ω (balanced) 12nH.
TX terminating impedance:	Z _{TX} = 50 Ω

Characteristics TX-RX				min.	typ. @ 25°C	max.	
Differential Mode Isolation α							
	1710.0	...	1785.0 MHz	53	58		dB
	1805.0	...	1880.0 MHz	50	53		dB
Common Mode Isolation							
	1710.0	...	1785.0 MHz	50	57		dB

Data Sheet

Characteristics

Temperature range for specification:	T = 25 °C
ANT terminating impedance:	Z _{ANT} = 50 Ω 3.9nH.
RX terminating impedance:	Z _{RX} = 100 Ω (balanced) 12nH.
TX terminating impedance:	Z _{TX} = 50 Ω

Characteristics TX-ANT		min.	typ. @ 25°C	max.	
Center frequency	f _C	–	1747.5	–	MHz
Maximum insertion attenuation	α _{max}				
1714.0 ... 1781.0 MHz			2.0	2.4	dB
1710.0 ... 1785.0 MHz			2.5	2.6	dB
Amplitude ripple per 5MHz channel	Δα				
1710.0 ... 1785.0 MHz			0.55	1.3	dB
VSWR					
TX port 1710.0 ... 1785.0 MHz			1.5	2.0	
ANT port 1710.0 ... 1785.0 MHz			1.5	2.0	
Attenuation	α				
10.0 ... 1565.42 MHz		30	33		dB
207.5 ... 222.0 MHz		50	62		dB
470.0 ... 770.0 MHz		35	40		dB
1565.42 ... 1573.374MHz		40	46		dB
1573.374... 1577.466MHz		42	47		dB
1577.466... 1585.42 MHz		40	44		dB
1597.5515...1605.886MHz		35	39		dB
1605.886... 1680.0 MHz		20	30		dB
1805.0 ... 1880.0 MHz		43	47		dB
1920.0 ... 1980.0 MHz		20	33		dB
2110.0 ... 2170.0 MHz		27	41		dB
2400.0 ... 2500.0 MHz		30	34		dB
2620.0 ... 2690.0 MHz		27	31		dB
3420.0 ... 3570.0 MHz		20	25		dB
5130.0 ... 5355.0 MHz		15	20		dB
5725.0 ... 5850.0 MHz		15	20		dB

Data Sheet

Characteristics

Temperature range for specification:	T = 25 °C
ANT terminating impedance:	Z _{ANT} = 50 Ω 3.9nH.
RX terminating impedance:	Z _{RX} = 100 Ω (balanced) 12nH.
TX terminating impedance:	Z _{TX} = 50 Ω

Characteristics ANT-RX		min.	typ. @ 25°C	max.	
Center frequency	f _C	–	1842.5	–	MHz
Maximum insertion attenuation	α _{max}				
1805.0 ... 1880.0 MHz			3.0	3.3	dB
Amplitude ripple per 5MHz channel	Δα				
1805.0 ... 1880.0 MHz			0.65	1.6	dB
Common mode rejection ratio					
1805.0 ... 1880.0 MHz		23 ¹⁾	25		dB
VSWR					
RX port	1805.0 ... 1880.0 MHz		1.6	2.0	
ANT port	1805.0 ... 1880.0 MHz		1.6	2.0	
Attenuation	α				
10.0 ... 1710.0 MHz		35	58		dB
1710.0 ... 1785.0 MHz		46	54		dB
1965.0 ... 2400.0 MHz		15	58		dB
2400.0 ... 2484.0 MHz		30	60		dB
2484.0 ... 5650.0 MHz		30	52		dB
IMD Product Level Limits²⁾	α				
at f_{TX}=1747.5MHz, f_{RX}=1842.5MHz					
Blocker 1	95.0 MHz		-115		dBm
Blocker 2	1652.5 MHz		-114		dBm
Blocker 3	3590.0 MHz		-110		dBm
Blocker 4	5337.5 MHz		-116		dBm

¹⁾ A combination of 10° phase balance and 1 dB amplitude balance corresponds to 19.6 dB CMRR

²⁾ IMD product level limits for power levels P_{TX}=21dBm (antenna port output power) and P_{Blocker}= -15dBm (antenna port input power)

Data Sheet

Characteristics

Temperature range for specification:	T = 25 °C
ANT terminating impedance:	Z _{ANT} = 50 Ω 3.9nH.
RX terminating impedance:	Z _{RX} = 100 Ω (balanced) 12nH.
TX terminating impedance:	Z _{TX} = 50 Ω

Characteristics TX-RX	min.	typ. @ 25°C	max.	
Differential Mode Isolation α				
1710.0 ... 1785.0 MHz	53	58		dB
1805.0 ... 1880.0 MHz	50	53		dB
Common Mode Isolation				
1710.0 ... 1785.0 MHz	50	57		dB

Maximum ratings

Storage temperature range	T_{stg}	-40 / +85	°C	
DC voltage	V_{DC}	5	V	
ESD voltage	V_{ESD}	50 ¹⁾	V	machine model, 10 pulses human body model, 1 pulse
	V_{ESD}	300 ²⁾	V	
Input Power at 1710.0 ... 1785.0 MHz elsewhere	P_{IN}	29	dBm	} continuous wave $T = 55^{\circ}\text{C}$, 5.000 h
		10	dBm	

1) acc. to JESD22-A115B (machine model), 10 negative & 10 positive pulses.

2) acc. to JESD22-A114F (human body model), 1 negative & 1 positive pulse.



Frequency Response TX-ANT

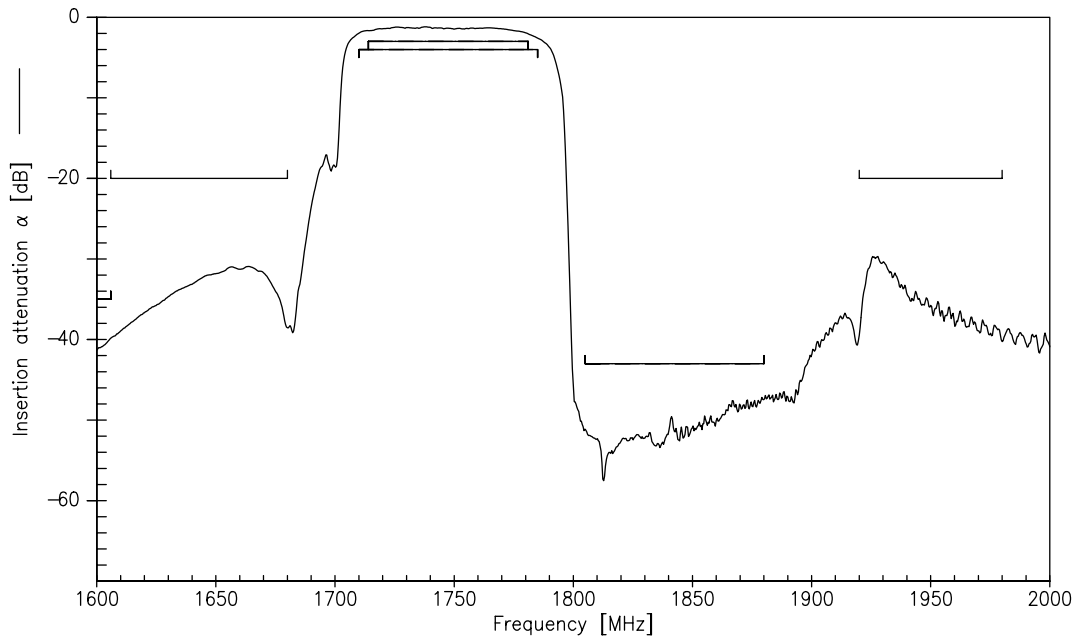

Frequency Response TX-ANT (wideband)

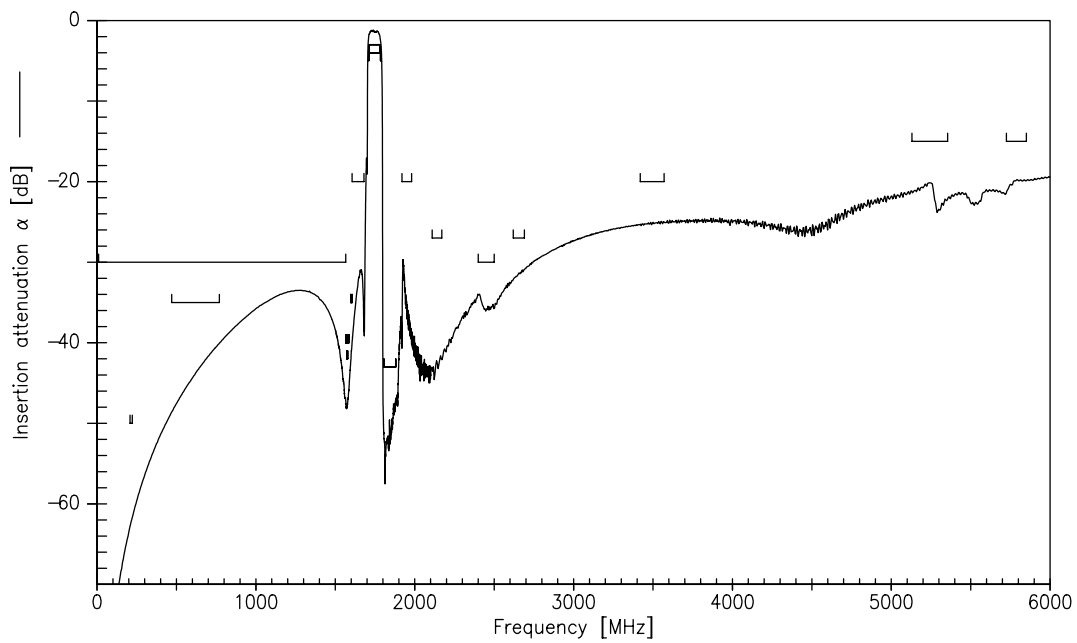



Frequency Response RX-ANT

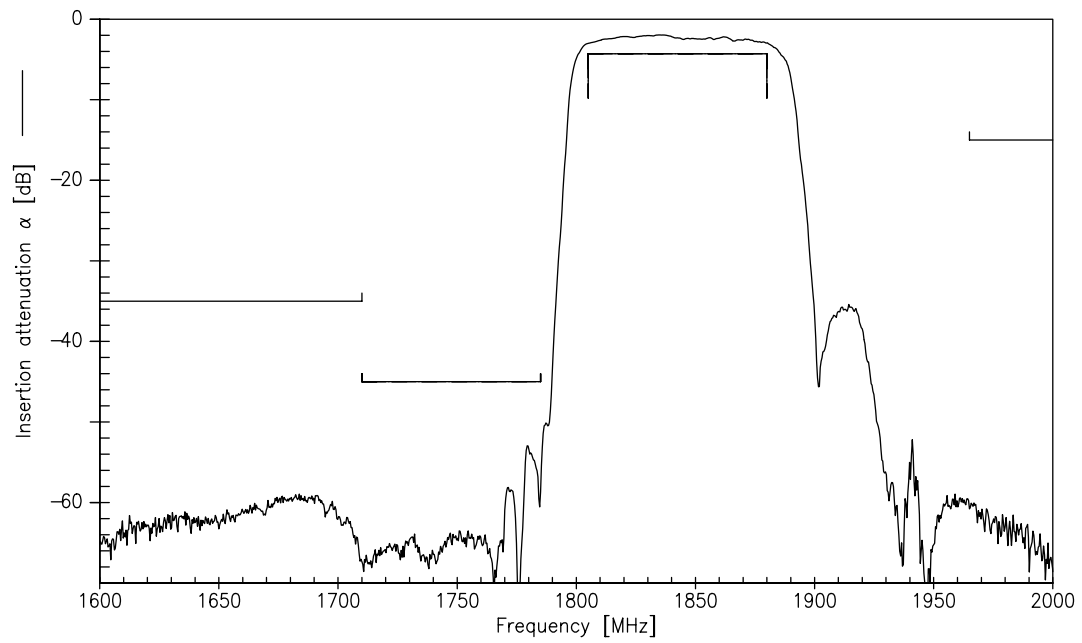

Frequency Response RX-ANT (wideband)

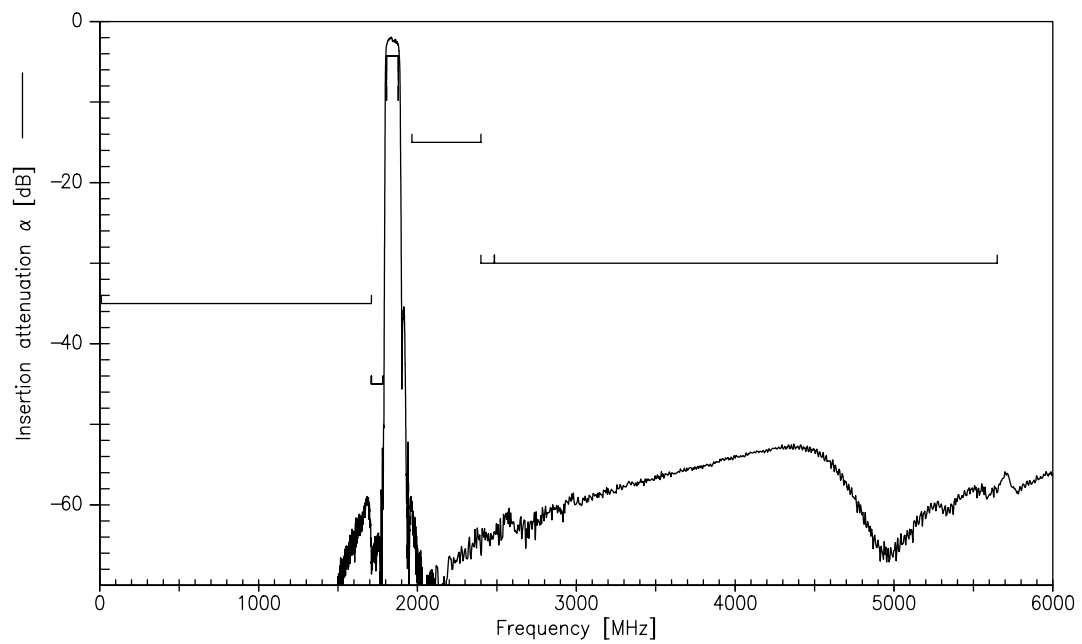



Frequency Response TX-RX (differential mode)

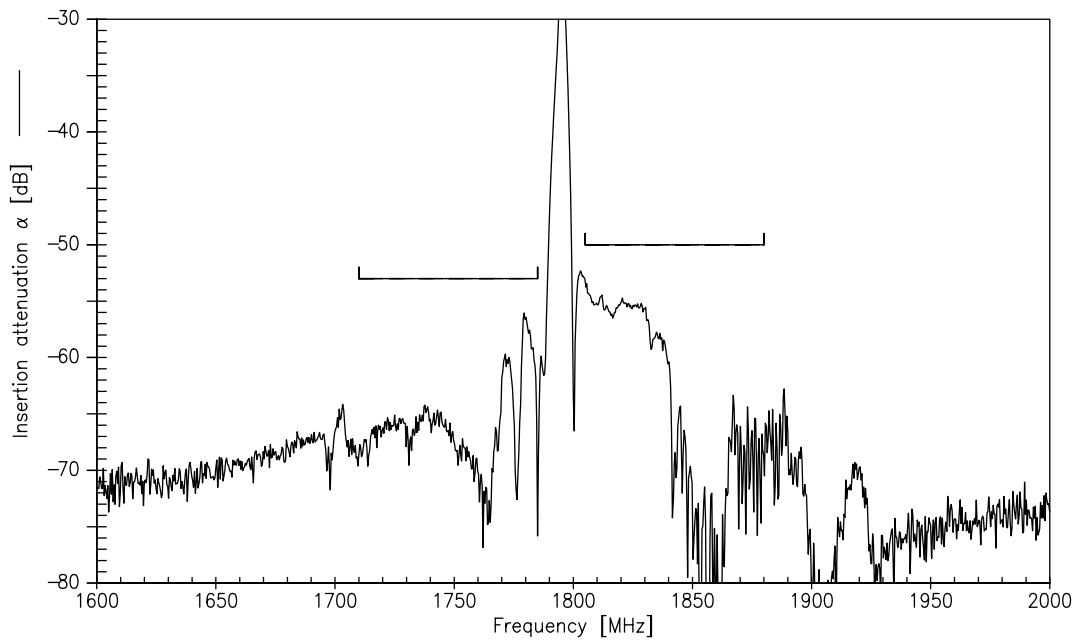

Frequency Response TX-RX (differential mode, wideband)

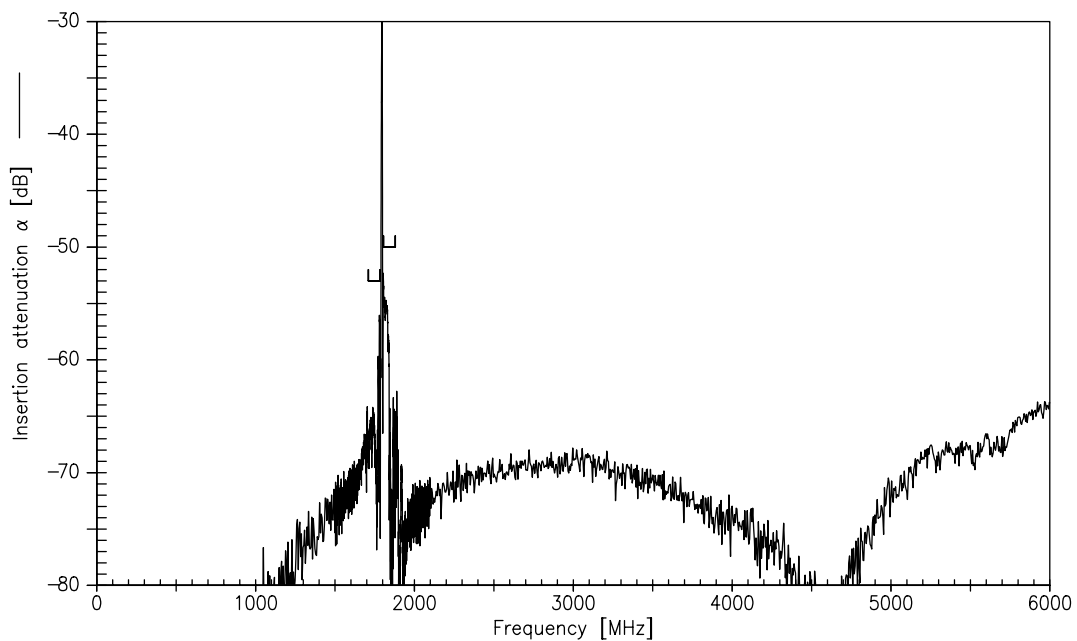



Frequency Response TX-RX (common mode)

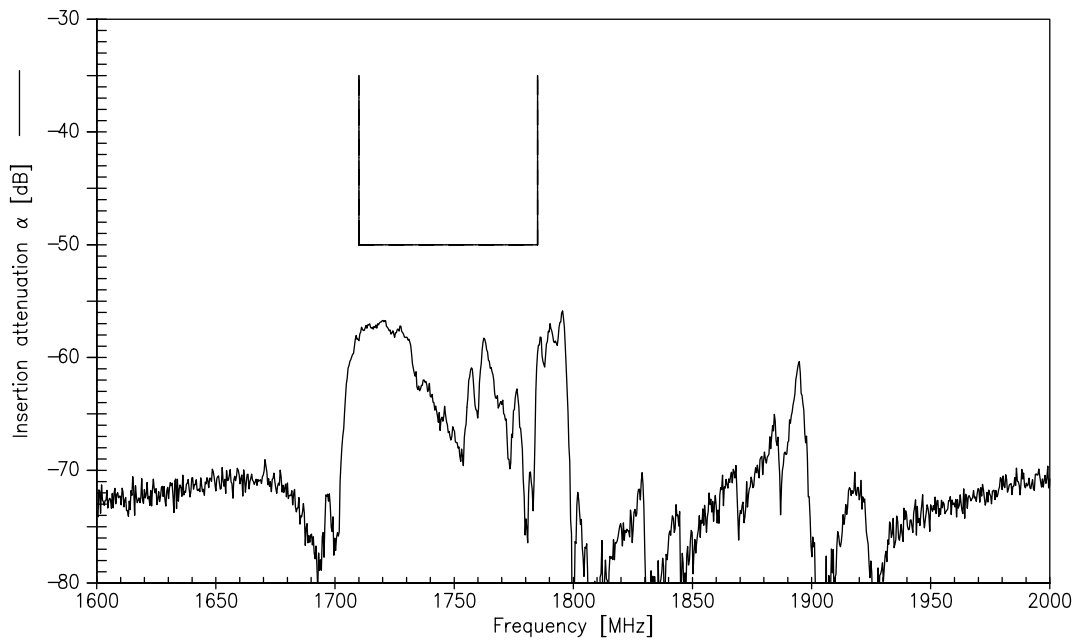

Frequency Response Common Mode Rejection Ratio

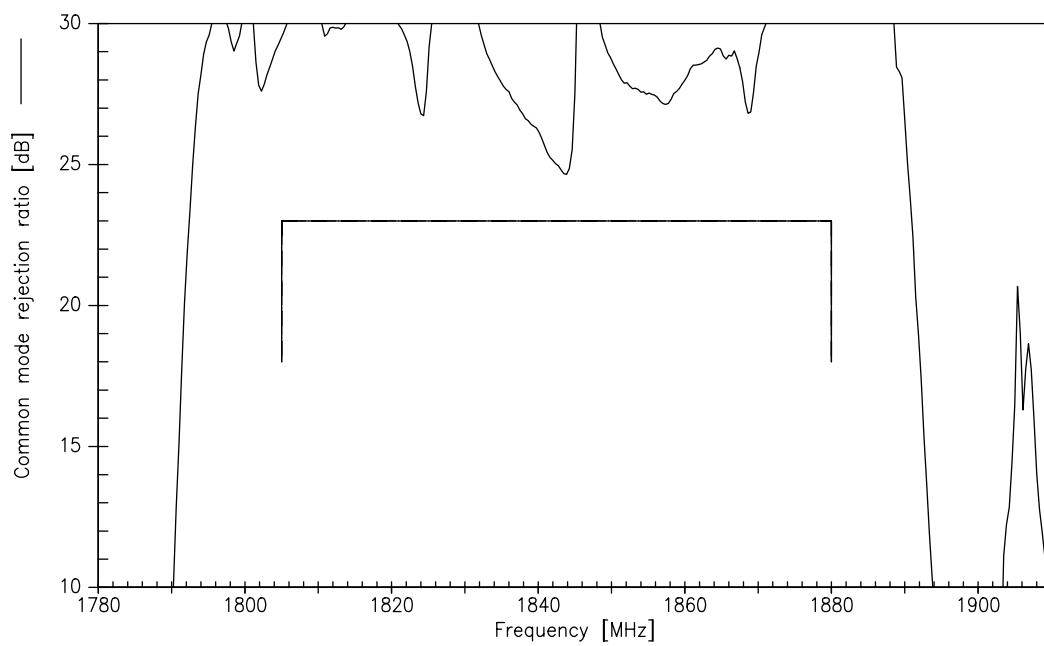

Data Sheet



VSWR at TX-, RX- and Antenna

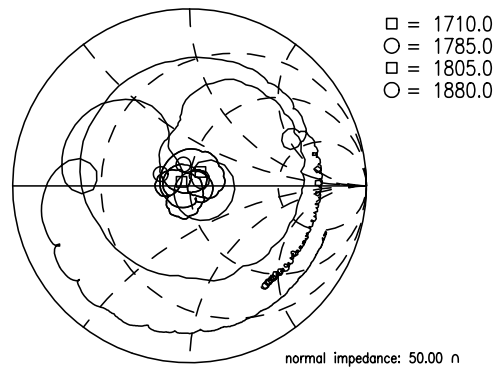
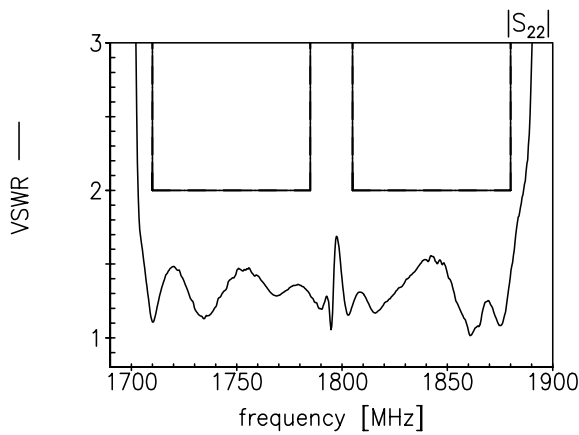
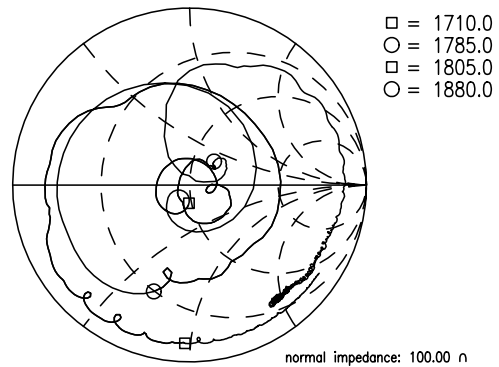
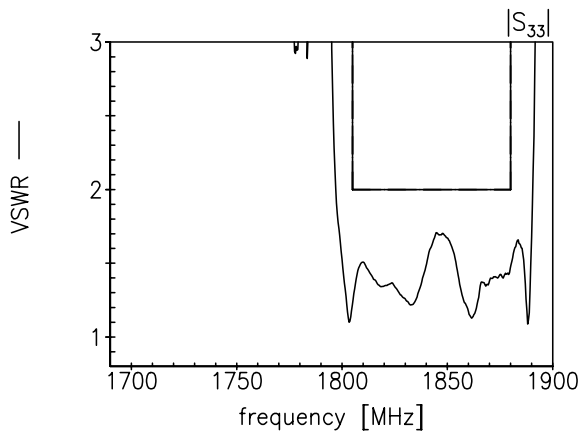
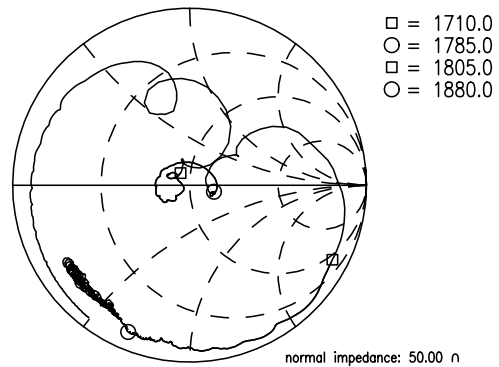
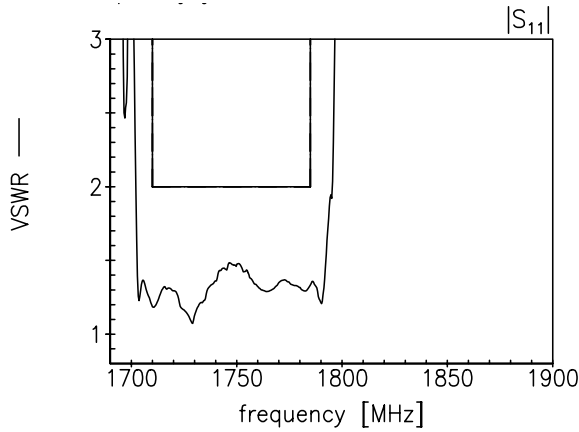

References

Type	B8088
Ordering code	B39182B8088P810
Marking and Package	C61157-A8-A64
Packaging	F61074-V8247-Z0000
Date Codes	L_1126
S-Parameters	B8088_NB_UN.s4p, B8088_WB_UN.s4p See file header for pin/port assignment.
Soldering profile	S_6001
RoHS compatible	defined as compatible with the following documents: "DIRECTIVE 2002/95/EC OF THE EUROPEAN PARLIAMENT AND OF THE COUNCIL of 27 January 2003 on the restriction of the use of certain hazardous substances in electrical and electronic equipment. 2005/618/EC from April 18th, 2005, amending Directive 2002/95/EC of the European Parliament and of the Council for the purposes of establishing the maximum concentration values for certain hazardous substances in electrical and electronic equipment."
Moldability	Before using in overmolding environment, please contact your EPCOS sales office.
Matching coils	See Inductor pdf-catalog http://www.tdk.co.jp/tefe02/coil.htm#aname1 and Data Library for circuit simulation http://www.tdk.co.jp/etvcl/index.htm

For further information please contact your local EPCOS sales office or visit our webpage at www.epcos.com.

Published by EPCOS AG
Systems, Acoustics, Waves Business Group
P.O. Box 80 17 09, 81617 Munich, GERMANY

© EPCOS AG 2013. This brochure replaces the previous edition.

For questions on technology, prices and delivery please contact the Sales Offices of EPCOS AG or the international Representatives.

Due to technical requirements components may contain dangerous substances. For information on the type in question please also contact one of our Sales Offices.

Important notes

The following applies to all products named in this publication:

1. Some parts of this publication contain **statements about the suitability of our products for certain areas of application**. These statements are based on our knowledge of typical requirements that are often placed on our products in the areas of application concerned. We nevertheless expressly point out **that such statements cannot be regarded as binding statements about the suitability of our products for a particular customer application**. As a rule, EPCOS is either unfamiliar with individual customer applications or less familiar with them than the customers themselves. For these reasons, it is always ultimately incumbent on the customer to check and decide whether an EPCOS product with the properties described in the product specification is suitable for use in a particular customer application.
2. We also point out that **in individual cases, a malfunction of electronic components or failure before the end of their usual service life cannot be completely ruled out in the current state of the art, even if they are operated as specified**. In customer applications requiring a very high level of operational safety and especially in customer applications in which the malfunction or failure of an electronic component could endanger human life or health (e.g. in accident prevention or life-saving systems), it must therefore be ensured by means of suitable design of the customer application or other action taken by the customer (e.g. installation of protective circuitry or redundancy) that no injury or damage is sustained by third parties in the event of malfunction or failure of an electronic component.
3. **The warnings, cautions and product-specific notes must be observed.**
4. In order to satisfy certain technical requirements, **some of the products described in this publication may contain substances subject to restrictions in certain jurisdictions (e.g. because they are classed as hazardous)**. Useful information on this will be found in our Material Data Sheets on the Internet (www.epcos.com/material). Should you have any more detailed questions, please contact our sales offices.
5. We constantly strive to improve our products. Consequently, **the products described in this publication may change from time to time**. The same is true of the corresponding product specifications. Please check therefore to what extent product descriptions and specifications contained in this publication are still applicable before or when you place an order. We also **reserve the right to discontinue production and delivery of products**. Consequently, we cannot guarantee that all products named in this publication will always be available. The aforementioned does not apply in the case of individual agreements deviating from the foregoing for customer-specific products.
6. Unless otherwise agreed in individual contracts, **all orders are subject to the current version of the "General Terms of Delivery for Products and Services in the Electrical Industry" published by the German Electrical and Electronics Industry Association (ZVEI)**.
7. The trade names EPCOS, BAOKE, Alu-X, CeraDiode, CeraLink, CeraPlas, CSMP, CSSP, CTVS, DeltaCap, DigiSiMic, DSSP, FilterCap, FormFit, MiniBlue, MiniCell, MKD, MKK, MLSC, MotorCap, PCC, PhaseCap, PhaseCube, PhaseMod, PhiCap, SIFERRIT, SIFI, SIKOREL, SilverCap, SIMDAD, SiMic, SIMID, SineFormer, SIOV, SIP5D, SIP5K, ThermoFuse, WindCap are **trademarks registered or pending** in Europe and in other countries. Further information will be found on the Internet at www.epcos.com/trademarks.