

$V_R$	1200V
$I_F$	5A
$Q_C$	17nC

### ●Features

- 1) Shorter recovery time
- 2) Reduced temperature dependence
- 3) High-speed switching possible

### ●Construction

Silicon carbide epitaxial planer schottky diode

### ●AEC-Q101 Qualified

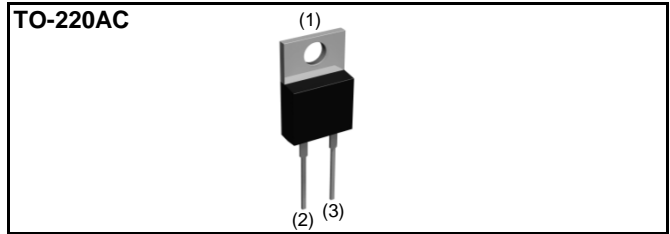

### ●Inner circuit

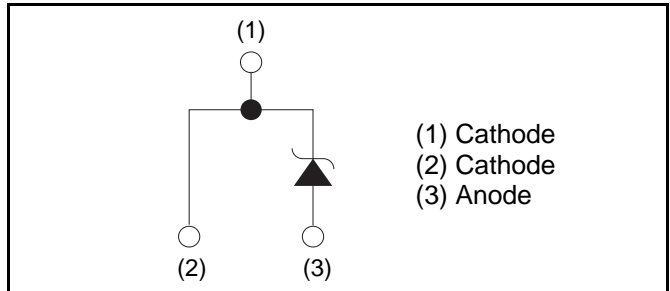

### ●Packaging specifications

Type	Packaging	Tube
	Reel size (mm)	-
	Tape width (mm)	-
	Basic ordering unit (pcs)	50
	Packing code	C
	Marking	SCS205KG

### ●Absolute maximum ratings ( $T_j = 25^\circ\text{C}$ )

Parameter	Symbol	Value	Unit
Reverse voltage (repetitive peak)	$V_{RM}$	1200	V
Reverse voltage (DC)	$V_R$	1200	V
Continuous forward current	$I_F$	5 <sup>*1</sup>	A
Surge no repetitive forward current	$I_{FSM}$	23 <sup>*2</sup>	A
		87 <sup>*3</sup>	A
		18 <sup>*4</sup>	A
Repetitive peak forward current	$I_{FRM}$	25 <sup>*5</sup>	A
Total power dissipation	$P_D$	88 <sup>*6</sup>	W
Junction temperature	$T_j$	175	$^\circ\text{C}$
Range of storage temperature	$T_{stg}$	-55 to +175	$^\circ\text{C}$

\*1  $T_c=150^\circ\text{C}$  \*2  $PW=8.3\text{ms}$  sinusoidal,  $T_j=25^\circ\text{C}$  \*3  $PW=10\mu\text{s}$  square,  $T_j=25^\circ\text{C}$

\*4  $PW=8.3\text{ms}$  sinusoidal,  $T_j=150^\circ\text{C}$  \*5  $T_c=100^\circ\text{C}$ ,  $T_j=150^\circ\text{C}$ , Duty cycle=10% \*6  $T_c=25^\circ\text{C}$

●Electrical characteristics (T<sub>j</sub> = 25°C)

Parameter	Symbol	Conditions	Values			Unit
			Min.	Typ.	Max.	
DC blocking voltage	V <sub>DC</sub>	I <sub>R</sub> =0.1mA	1200	-	-	V
Forward voltage	V <sub>F</sub>	I <sub>F</sub> =5A, T <sub>j</sub> =25°C	-	1.4	1.6	V
		I <sub>F</sub> =5A, T <sub>j</sub> =150°C	-	1.8	-	V
		I <sub>F</sub> =5A, T <sub>j</sub> =175°C	-	1.9	-	V
Reverse current	I <sub>R</sub>	V <sub>R</sub> =1200V, T <sub>j</sub> =25°C	-	5	100	μA
		V <sub>R</sub> =1200V, T <sub>j</sub> =150°C	-	40	-	μA
		V <sub>R</sub> =1200V, T <sub>j</sub> =175°C	-	65	-	μA
Total capacitance	C	V <sub>R</sub> =1V, f=1MHz	-	270	-	pF
		V <sub>R</sub> =800V, f=1MHz	-	21	-	pF
Total capacitive charge	Q <sub>C</sub>	V <sub>R</sub> =800V, di/dt=500A/μs	-	17	-	nC
Switching time	t <sub>c</sub>	V <sub>R</sub> =800V, di/dt=500A/μs	-	15	-	ns

## ●Thermal characteristics

Parameter	Symbol	Conditions	Values			Unit
			Min.	Typ.	Max.	
Thermal resistance	R <sub>th(j-c)</sub>	-	-	1.5	1.7	°C/W

●Electrical characteristic curves

Fig.1  $V_F - I_F$  Characteristics

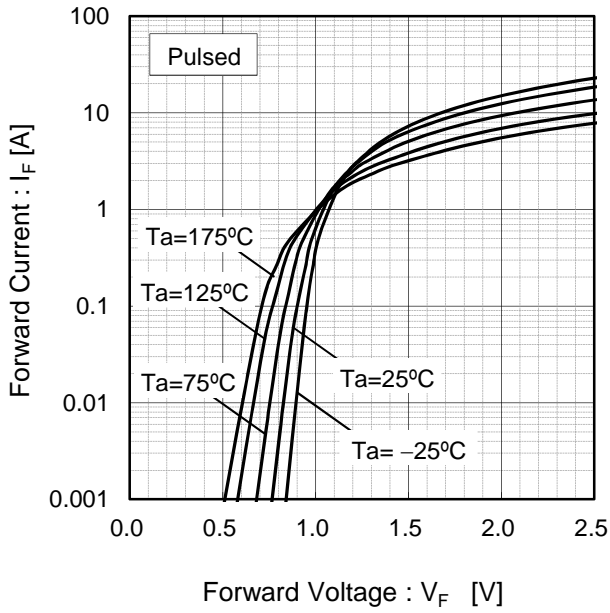

Fig.2  $V_F - I_F$  Characteristics

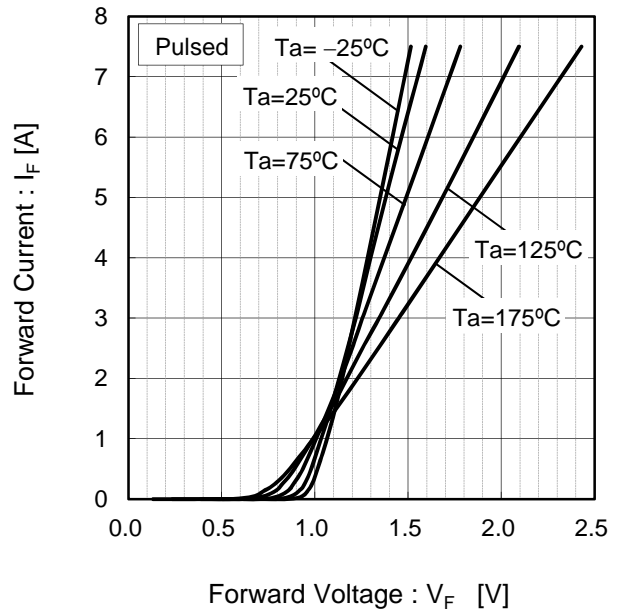

Fig.3  $V_R - I_R$  Characteristics

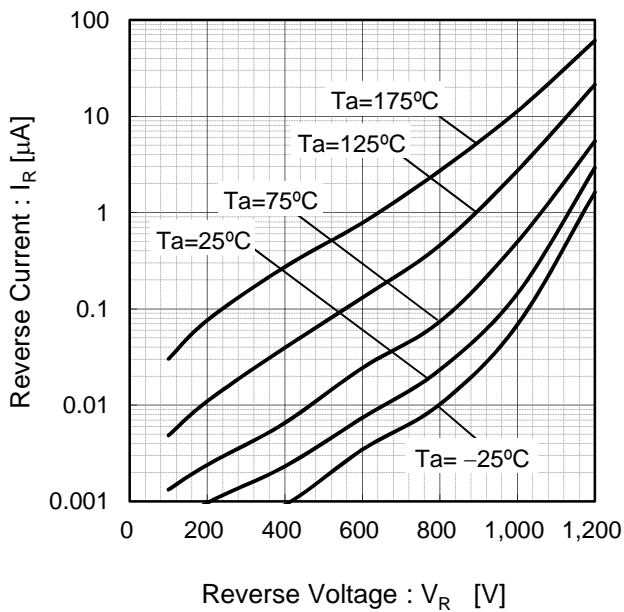
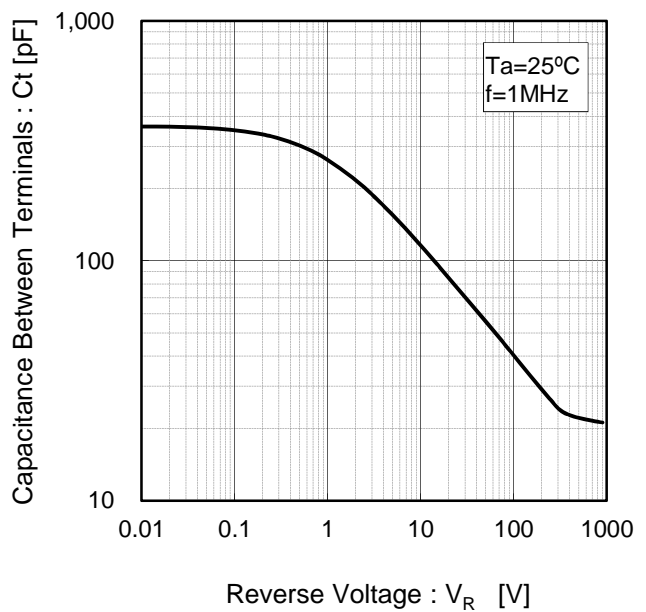

Fig.4  $V_R - C_t$  Characteristics



●Electrical characteristic curves

Fig.5 Thermal Resistance vs. Pulse Width

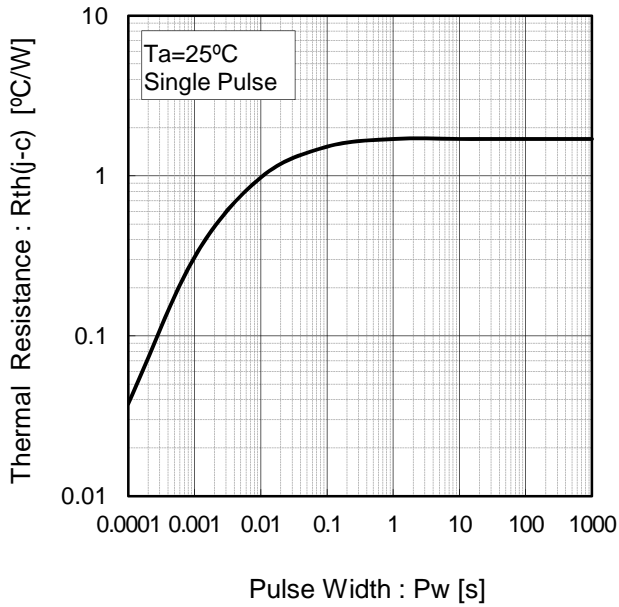

Fig.6 Power Dissipation

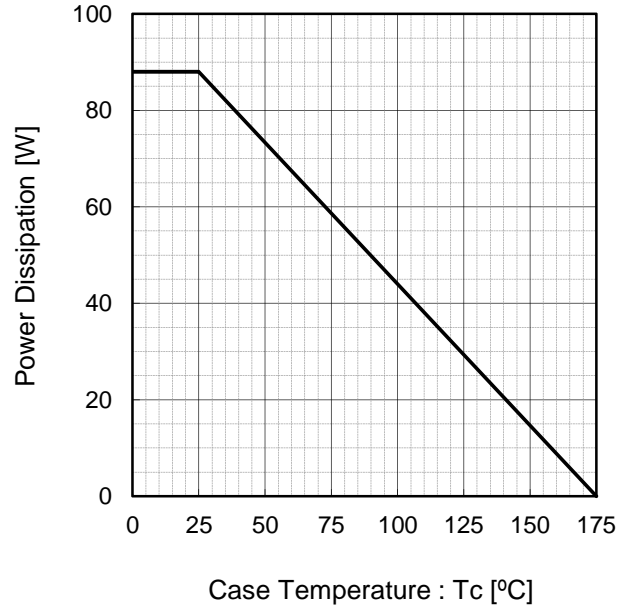

Fig.7  $I_p$ - $T_c$  Derating Curve

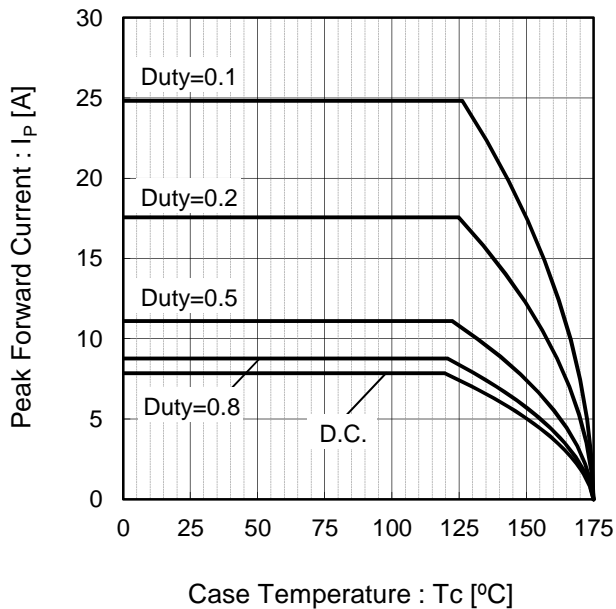
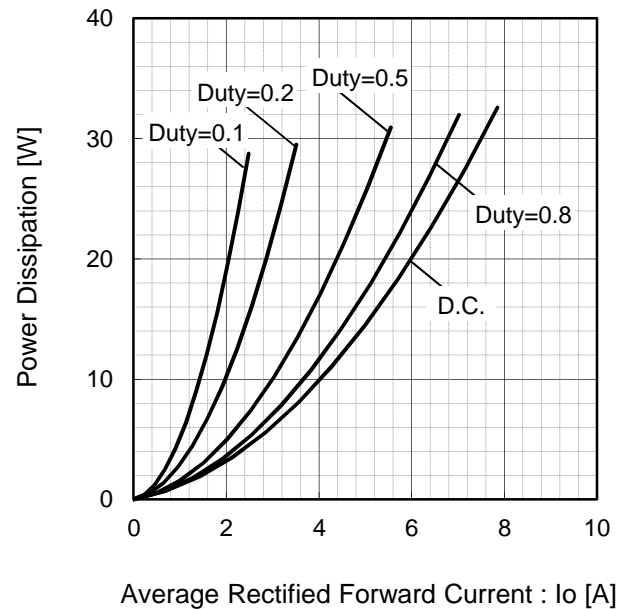
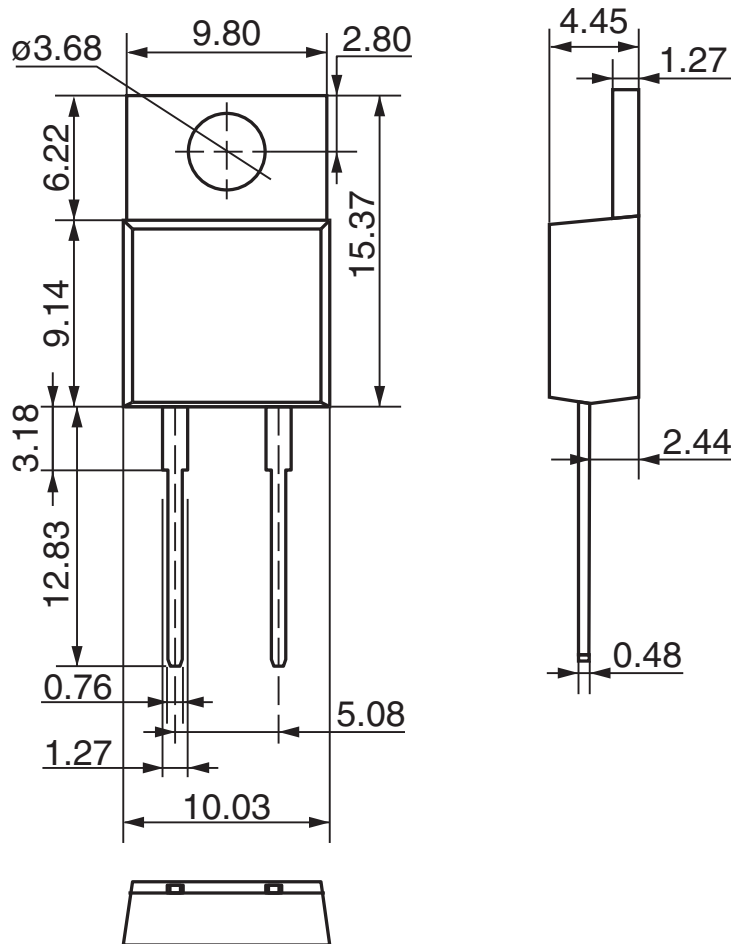

Fig.8  $I_o$ - $P_f$  Characteristics



## ●Dimensions (Unit : mm)

## TO-220AC



## Notes

- 1) The information contained herein is subject to change without notice.
- 2) Before you use our Products, please contact our sales representative and verify the latest specifications :
- 3) Although ROHM is continuously working to improve product reliability and quality, semiconductors can break down and malfunction due to various factors.  
Therefore, in order to prevent personal injury or fire arising from failure, please take safety measures such as complying with the derating characteristics, implementing redundant and fire prevention designs, and utilizing backups and fail-safe procedures. ROHM shall have no responsibility for any damages arising out of the use of our Products beyond the rating specified by ROHM.
- 4) Examples of application circuits, circuit constants and any other information contained herein are provided only to illustrate the standard usage and operations of the Products. The peripheral conditions must be taken into account when designing circuits for mass production.
- 5) The technical information specified herein is intended only to show the typical functions of and examples of application circuits for the Products. ROHM does not grant you, explicitly or implicitly, any license to use or exercise intellectual property or other rights held by ROHM or any other parties. ROHM shall have no responsibility whatsoever for any dispute arising out of the use of such technical information.
- 6) The Products specified in this document are not designed to be radiation tolerant.
- 7) For use of our Products in applications requiring a high degree of reliability (as exemplified below), please contact and consult with a ROHM representative : transportation equipment (i.e. cars, ships, trains), primary communication equipment, traffic lights, fire/crime prevention, safety equipment, medical systems, servers, solar cells, and power transmission systems.
- 8) Do not use our Products in applications requiring extremely high reliability, such as aerospace equipment, nuclear power control systems, and submarine repeaters.
- 9) ROHM shall have no responsibility for any damages or injury arising from non-compliance with the recommended usage conditions and specifications contained herein.
- 10) ROHM has used reasonable care to ensure the accuracy of the information contained in this document. However, ROHM does not warrant that such information is error-free, and ROHM shall have no responsibility for any damages arising from any inaccuracy or misprint of such information.
- 11) Please use the Products in accordance with any applicable environmental laws and regulations, such as the RoHS Directive. For more details, including RoHS compatibility, please contact a ROHM sales office. ROHM shall have no responsibility for any damages or losses resulting from non-compliance with any applicable laws or regulations.
- 12) When providing our Products and technologies contained in this document to other countries, you must abide by the procedures and provisions stipulated in all applicable export laws and regulations, including without limitation the US Export Administration Regulations and the Foreign Exchange and Foreign Trade Act.
- 13) This document, in part or in whole, may not be reprinted or reproduced without prior consent of ROHM.



Thank you for your accessing to ROHM product informations.  
More detail product informations and catalogs are available, please contact us.

## ROHM Customer Support System

<http://www.rohm.com/contact/>



SCS205KGHR - Web Page

Part Number	SCS205KGHR
Package	TO-220AC
Unit Quantity	1000
Minimum Package Quantity	50
Packing Type	Tube
Constitution Materials List	inquiry
RoHS	Yes