

Voltage Detector IC Series

Bipolar Voltage Detector ICs

BD47xx series

● **General Description**

The BD47xx series is a Voltage Detector IC, developed to prevent system errors at transient state, when the power of CPU or logic circuit switches ON/OFF or in cases of momentary shut down. These ICs consist of three terminals (power supply, GND and reset output) to detect power supply voltages and outputs reset signals of various systems. These ICs are ultra-compact and have low current consumption, making them ideal for portable products.

● **Features**

- High accuracy detection
- Low current consumption
- Very small package
- Open collector "L" reset output
- Package SSOP5 is similar to SOT-23-5 (JEDEC)

● **Key Specifications**

- Detection voltage range: 1.9V to 4.6V (Typ.)
0.1V steps
- High accuracy detection voltage: ±1%
- Low current consumption: 1.6µA (Typ.)
- Operating temperature range: -40°C to +75°C

● **Package**
SSOP5



2.90mm x 2.80mm x 1.25mm

● **Applications**

Circuits using microcontrollers or logic circuits that require a reset.

● **Typical Application Circuit**

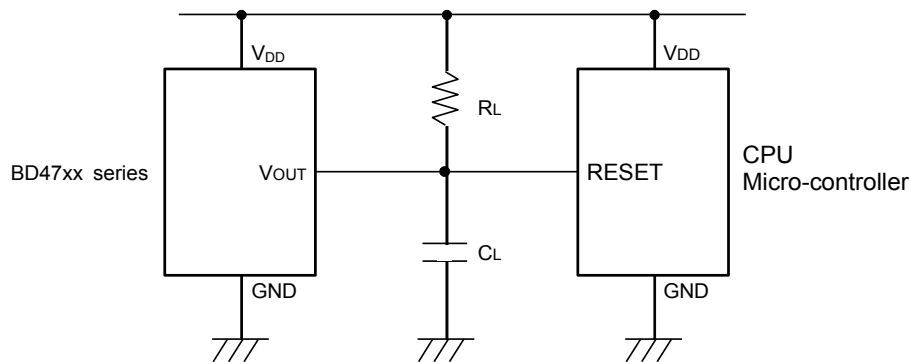

● **Connection Diagram**
SSOP5

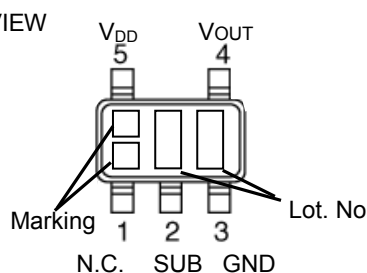

● **Pin Descriptions**

PIN No.	Symbol	Function
1	N.C.	Unconnected Terminal
2	SUB	Substrate*
3	GND	GND
4	VOUT	Reset Output
5	V _{DD}	Power Supply Voltage

*Substrate Pin should be connected with GND

● Ordering Information

B **D** **4** **7** **x** **x** **G** - **T** **R**

Part Number	Reset Voltage Value 19 : 1.9V ↓ 0.1V step 46 : 4.6V	Package G : SSOP5
		Packaging and forming specification TR : Embossed tape and reel

SSOP5 (SOT-23-5)

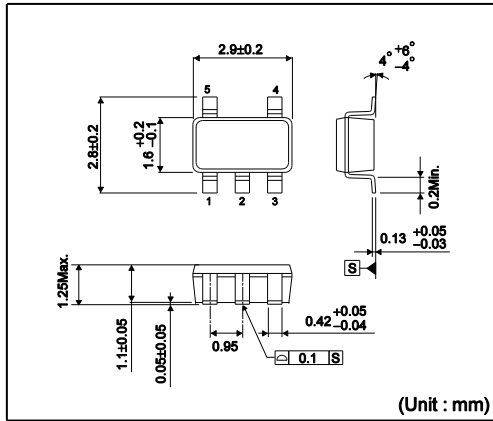

<Tape and Reel information>

Tape	Embossed carrier tape
Quantity	3000pcs
Direction of feed	TR (The direction is the 1pin of product is at the upper right when you hold reel on the left hand and you pull out the tape on the right hand)

*Order quantity needs to be multiple of the minimum quantity.

● Lineup

Marking	Detection Voltage	Part Number	Marking	Detection Voltage	Part Number	Marking	Detection Voltage	Part Number
B2	4.6V	BD4746	BR	3.6V	BD4736	BH	2.6V	BD4726
B1	4.5V	BD4745	BQ	3.5V	BD4735	BG	2.5V	BD4725
BZ	4.4V	BD4744	BP	3.4V	BD4734	BF	2.4V	BD4724
BY	4.3V	BD4743	B4	3.3V	BD4733	BE	2.3V	BD4723
BX	4.2V	BD4742	BN	3.2V	BD4732	BD	2.2V	BD4722
BW	4.1V	BD4741	BM	3.1V	BD4731	BC	2.1V	BD4721
BV	4.0V	BD4740	BL	3.0V	BD4730	BB	2.0V	BD4720
BU	3.9V	BD4739	BK	2.9V	BD4729	BA	1.9V	BD4719
BT	3.8V	BD4738	BJ	2.8V	BD4728			
BS	3.7V	BD4737	B3	2.7V	BD4727			

● Absolute maximum ratings

Parameter	Symbol	Limit	Unit
Power Supply Voltage	V_{DD}	-0.3 to +10	V
Output Voltage	V_{OUT}	-0.3 to +10	V
Output Current	I_o	60	mA
Power Dissipation ^{*1 *2}	P_d	540	mW
Operation Temperature Range	T_{opt}	-40 to +75	°C
Ambient Storage Temperature	T_{stg}	-55 to +125	°C

*1 Reduced by 5.4mW/°C when used over 25°C.

*2 When mounted on ROHM standard circuit board (70mm×70mm×1.6mm, glass epoxy board).

● Electrical characteristics (Unless Otherwise Specified $T_a=25^\circ\text{C}$)

Parameter	Symbol	Condition	Limit			Unit	
			Min.	Typ.	Max.		
Detection Voltage	V_{DET}	$V_{DD}=H \rightarrow L$ $R_L=4.7k\Omega$	$V_{DET}(T) \times 0.99$	$V_{DET}(T)$	$V_{DET}(T) \times 1.01$	V	
		$V_{DET}=2.5V$	$T_a=+25^\circ\text{C}$	2.475	2.5		2.525
			$T_a=-40^\circ\text{C}$ to 75°C	2.418	-		2.584
		$V_{DET}=3.0V$	$T_a=+25^\circ\text{C}$	2.970	3.0		3.030
			$T_a=-40^\circ\text{C}$ to 75°C	2.901	-		3.100
		$V_{DET}=3.3V$	$T_a=+25^\circ\text{C}$	3.267	3.3		3.333
	$T_a=-40^\circ\text{C}$ to 75°C	3.191	-	3.410			
	$V_{DET}=4.2V$	$T_a=+25^\circ\text{C}$	4.158	4.2	4.242		
		$T_a=-40^\circ\text{C}$ to 75°C	4.061	-	4.341		
Temperature Coefficient Of Detection Voltage	$V_{DET}/\Delta T$	$R_L=4.7k\Omega$ $T_a=-20$ to $+75^\circ\text{C}$ Designed Guarantee	-	± 0.01	-	%/°C	
Detection Hysteresis Voltage	ΔV_{DET}	$R_L=4.7k\Omega$, $V_{DD}=L \rightarrow H \rightarrow L$	30	50	100	mV	
Transfer Delay Time "H"	t_{PLH}	$C_L=100pF$, $R_L=4.7k\Omega$ ^{*1}	-	20	50	μs	
Transfer Delay Time "L"	t_{PHL}	$C_L=100pF$, $R_L=4.7k\Omega$ ^{*2}	-	60	120	μs	
Reset Output Voltage "L"	V_{OL}	$V_{DD}=V_{DET}(\text{min.})-0.05V$, $R_L=4.7k\Omega$	-	0.1	0.4	V	
Circuit Current ON	I_{CC1}	$V_{DD}=V_{DET}(\text{min.})-0.05V$, $R_L=\infty$	-	1.5	3.0	μA	
Circuit Current OFF	I_{CC2}	$V_{DD}=V_{DET}(\text{typ.})/0.85V$, $R_L=\infty$	-	1.6	3.2	μA	
Operating Voltage Range	V_{OPL}	$R_L=4.7k\Omega$, $V_{OL} \leq 0.4V$	-	0.65	0.85	V	
Output Leak Current	I_{leak}	$V_{DD}=V_{OUT}=10V$	-	-	0.1	μA	
Reset Output Current "L"	I_{OL}	$V_o=0.4V$, $V_{DD}=V_{DET}(\text{min.})-0.05V$	3.0	15.0	-	mA	

$V_{DET}(T)$: Standard Detection Voltage (1.9V to 4.6V, 0.1V step)

R_L : Pull-up resistor to be connected between V_{OUT} and power supply.

C_L : Capacitor to be connected between V_{OUT} and GND.

*1 t_{PLH} : $V_{DD}=(V_{DET}(\text{typ.})-0.4V) \rightarrow (V_{DET}(\text{typ.})+0.4V)$

*2 t_{PHL} : $V_{DD}=(V_{DET}(\text{typ.})+0.4V) \rightarrow (V_{DET}(\text{typ.})-0.4V)$

Design Guarantee. (Outgoing inspection is not done on all products)

●Block Diagram

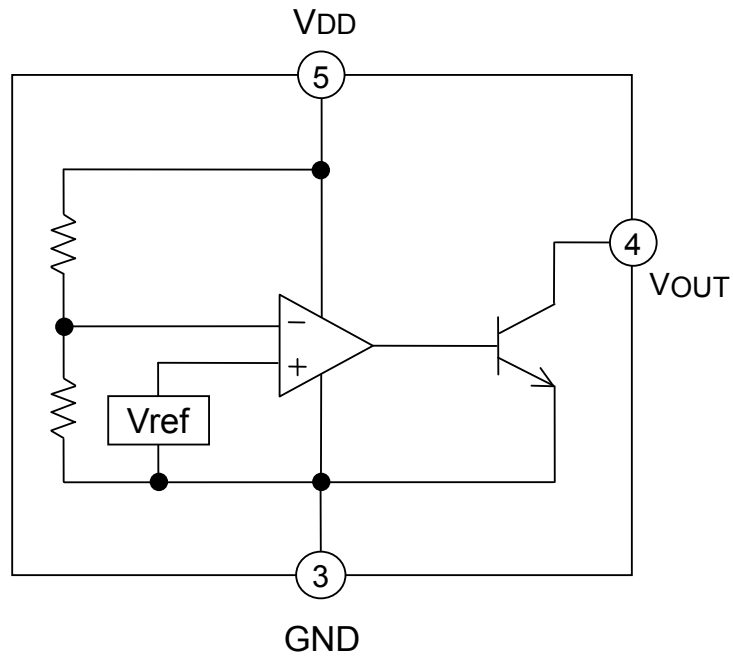

Fig.1 BD47xx series

● Typical Performance Curves

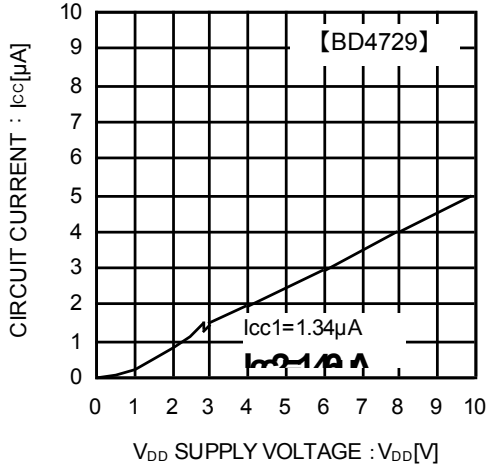

Fig.2 Circuit Current

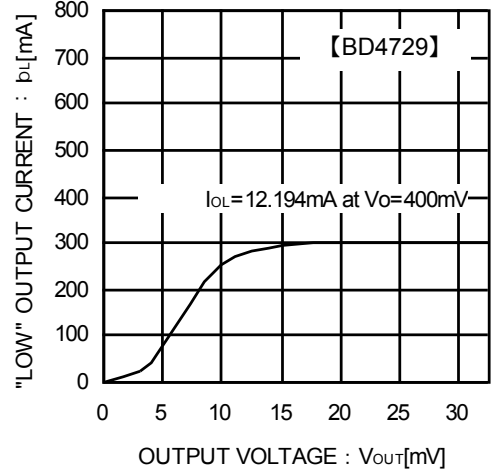

Fig.3 "Low" Output Current

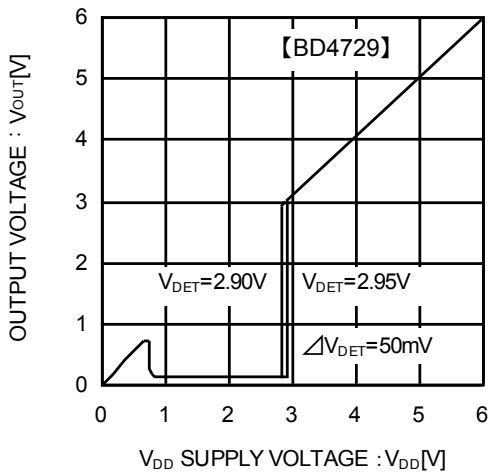

Fig.4 I/O Characteristics

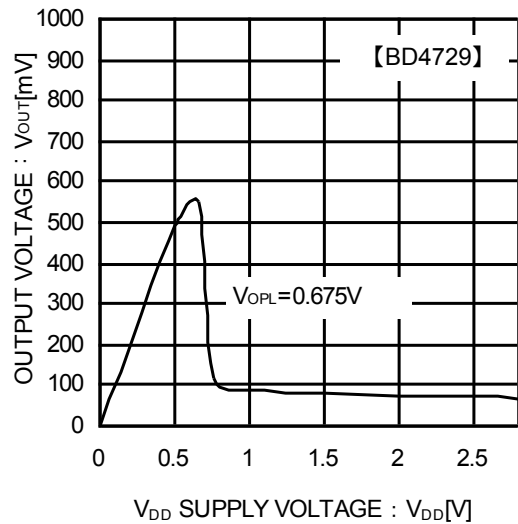

Fig.5 Operating Limit Voltage

● Typical Performance Curves – continued

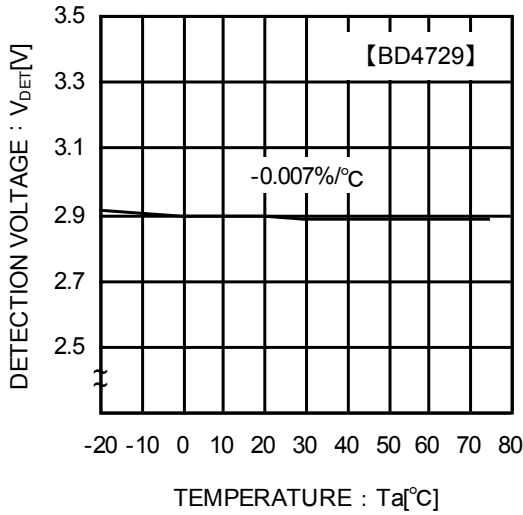

Fig.6 Detection Voltage

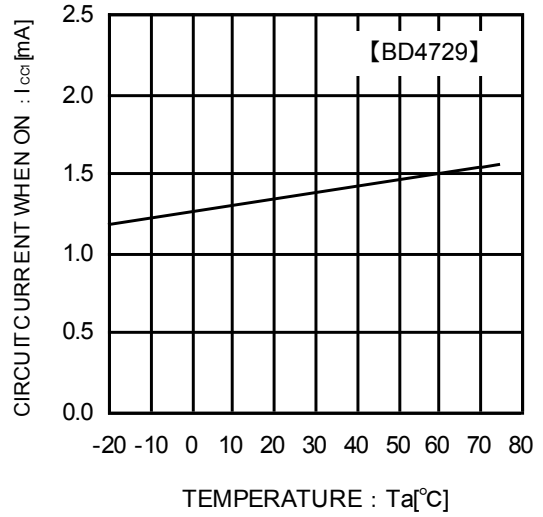

Fig.7 Circuit Current when ON

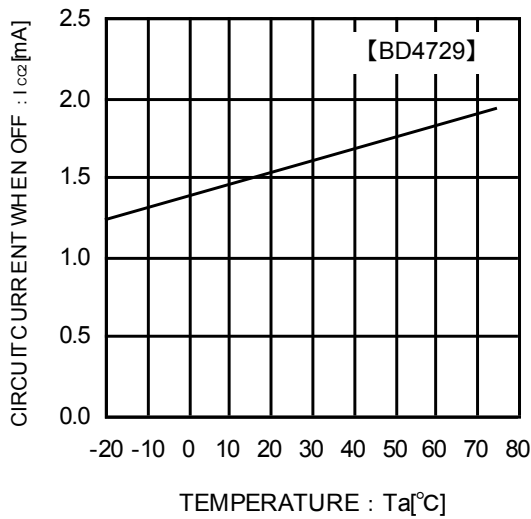

Fig.8 Circuit Current when OFF

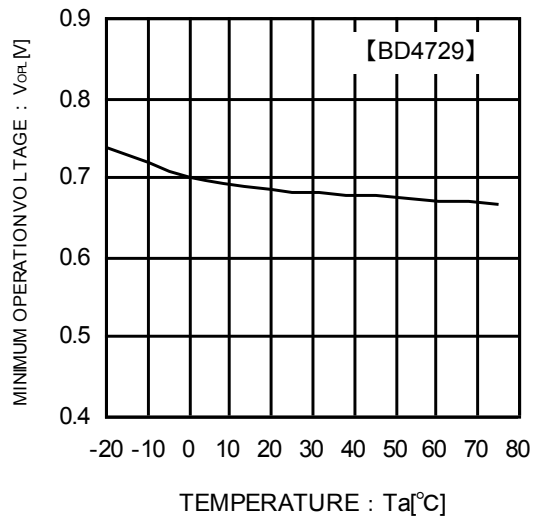

Fig.9 Operating Limit Voltage

● Typical Performance Curves – continued

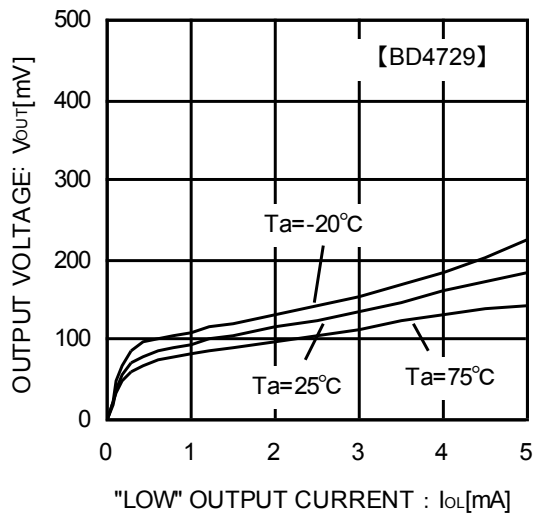

Fig.10 Output Saturation Voltage

● Application Information

Explanation of Operation

BD47xx series has threshold voltages namely the detection voltage and release voltage. As the voltages applied to the input reach their respective thresholds, the output switches from “High” to “Low” and from “Low” to “High”. The release voltage has a hysteresis that is the value of the detection voltage +50mV (Typ.), preventing chattering in the output. When the input is greater than the release voltage, the output is in a “High” state. When the input decreases from that state, the output switches to “Low” upon reaching the detection voltage. When the input is less than the detection voltage, the output is in a “Low” state. When the input increases from that state, the output switches to “High” upon reaching the release voltage. Additionally, at least 0.85V input voltage is required for the circuit to function as expected. When the input falls below the operating limit voltage, the output becomes unstable.

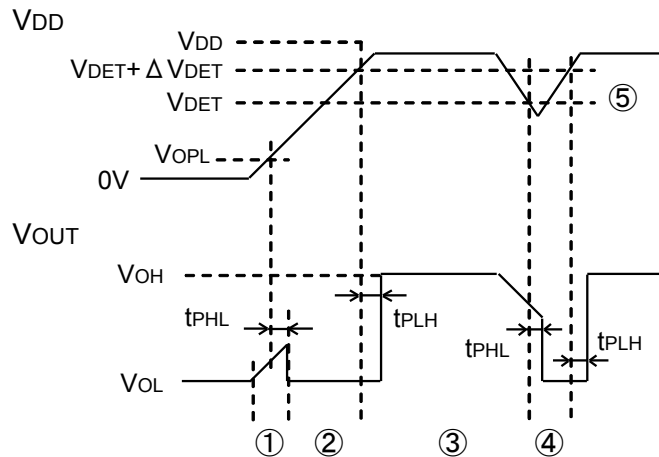

Fig.11 Timing Waveform

- ① When the power supply is turned on, the output is still unstable until it reaches the operating limit voltage (V_{OPL}) with a given time t_{PHL} . Therefore it is possible that the reset signal is not outputted when the rise time of V_{DD} is faster than t_{PHL} .
- ② When V_{DD} is greater than V_{OPL} but less than the reset release voltage ($V_{DET} + \Delta V_{DET}$), the output voltages will switch to Low.
- ③ If V_{DD} exceeds the reset release voltage ($V_{DET} + \Delta V_{DET}$) then V_{OUT} switches from L to H after t_{PLH} .
- ④ If V_{DD} drops below the detection voltage (V_{DET}) when the power supply is powered down or when there is a power supply fluctuation, V_{OUT} switches to L (with a delay of t_{PHL}).
- ⑤ The potential difference between the detection voltage and the release voltage is known as the Hysteresis Width (ΔV_{DET}). The system is designed such that, the output does not toggle with power supply fluctuations within this hysteresis width, malfunctions due to noise are prevented.

<Precautions>

Please be aware that when there is resistance on the power supply line, the detection voltage varies with voltage drops caused by the IC current consumption.

Please connect a capacitor between V_{DD} and GND when the power supply line has high impedance.

●Circuit Applications

The following is an example of an application circuit using Reset IC for normal power supply detection. BD47xx series requires a pull up resistor on the output terminal. The pull up resistor value should be decided depending on the application, with enough consideration of power supply level and output current capability. When a capacitor is placed at the output terminal, to delay the output time or to remove noise, the output will become slower during starting or stopping. Please be careful in considering the appropriate value for pull up resistors, output current, and capacitor when inserting a bypass capacitor between input and GND. Please be aware that if an extremely large capacitor is used, the response time will become excessively slow.

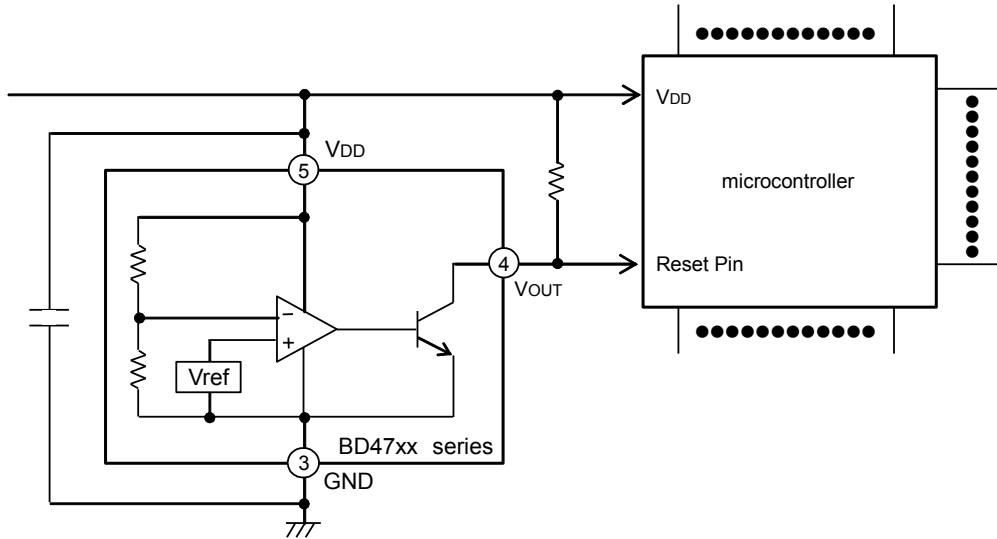

Fig.12 Circuit Applications

●Operational Notes

- 1) Absolute maximum ratings
Operating the IC over the absolute maximum ratings may damage the IC. The damage can either be a short circuit between pins or an open circuit between pins. Therefore, it is important to consider circuit protection measures, such as adding a fuse, in case the IC is operated over the absolute maximum ratings.
- 2) Ground Voltage
The voltage of the ground pin must be the lowest voltage of all pins of the IC at all operating conditions. Ensure that no pins are at a voltage below the ground pin at any time, even during transient condition.
- 3) Recommended operating conditions
These conditions represent a range within which the expected characteristics of the IC can be approximately obtained. The electrical characteristics are guaranteed under the conditions of each parameter.
- 4) Bypass Capacitor for Noise Rejection
To help reject noise, put a 1 μ F capacitor between V_{DD} pin and GND and 1000pF capacitor between V_{OUT} pin and GND. Be careful when using extremely big capacitor as transient response will be affected.
- 5) Short between pins and mounting errors
Be careful when mounting the IC on printed circuit boards. The IC may be damaged if it is mounted in a wrong orientation or if pins are shorted together. Short circuit may be caused by conductive particles caught between the pins.
- 6) Operation under strong electromagnetic field
Operating the IC in the presence of a strong electromagnetic field may cause the IC to malfunction.
- 7) The V_{DD} line impedance might cause oscillation because of the detection current.
- 8) A V_{DD} to GND capacitor (as close connection as possible) should be used in high V_{DD} line impedance condition.
- 9) Lower than the minimum input voltage puts the V_{OUT} in high impedance state, and it must be V_{DD} in pull up (V_{DD}) condition.
- 10) External parameters
The recommended parameter range for R_L is 2k Ω to 1M Ω . There are many factors (board layout, etc) that can affect characteristics. Please verify and confirm using practical applications.
- 11) Power on reset operation
Please note that the power on reset output varies with the V_{DD} rise time. Please verify the behavior in the actual operation.
- 12) Testing on application boards
When testing the IC on an application board, connecting a capacitor directly to a low-impedance output pin may subject the IC to stress. Always discharge capacitors completely after each process or step. The IC's power supply should always be turned off completely before connecting or removing it from the test setup during the inspection process. To prevent damage from static discharge, ground the IC during assembly and use similar precautions during transport and storage.
- 13) Rush current
When power is first supplied to the IC, rush current may flow instantaneously. It is possible that the charge current to the parasitic capacitance of internal photo diode or the internal logic may be unstable. Therefore, give special consideration to power coupling capacitance, power wiring, width of GND wiring, and routing of connections.

Notice

Precaution on using ROHM Products

- Our Products are designed and manufactured for application in ordinary electronic equipments (such as AV equipment, OA equipment, telecommunication equipment, home electronic appliances, amusement equipment, etc.). If you intend to use our Products in devices requiring extremely high reliability (such as medical equipment ^(Note 1), transport equipment, traffic equipment, aircraft/spacecraft, nuclear power controllers, fuel controllers, car equipment including car accessories, safety devices, etc.) and whose malfunction or failure may cause loss of human life, bodily injury or serious damage to property ("Specific Applications"), please consult with the ROHM sales representative in advance. Unless otherwise agreed in writing by ROHM in advance, ROHM shall not be in any way responsible or liable for any damages, expenses or losses incurred by you or third parties arising from the use of any ROHM's Products for Specific Applications.

(Note1) Medical Equipment Classification of the Specific Applications

JAPAN	USA	EU	CHINA
CLASS III	CLASS III	CLASS II b	CLASS III
CLASS IV		CLASS III	

- ROHM designs and manufactures its Products subject to strict quality control system. However, semiconductor products can fail or malfunction at a certain rate. Please be sure to implement, at your own responsibilities, adequate safety measures including but not limited to fail-safe design against the physical injury, damage to any property, which a failure or malfunction of our Products may cause. The following are examples of safety measures:
 - Installation of protection circuits or other protective devices to improve system safety
 - Installation of redundant circuits to reduce the impact of single or multiple circuit failure
- Our Products are designed and manufactured for use under standard conditions and not under any special or extraordinary environments or conditions, as exemplified below. Accordingly, ROHM shall not be in any way responsible or liable for any damages, expenses or losses arising from the use of any ROHM's Products under any special or extraordinary environments or conditions. If you intend to use our Products under any special or extraordinary environments or conditions (as exemplified below), your independent verification and confirmation of product performance, reliability, etc. prior to use, must be necessary:
 - Use of our Products in any types of liquid, including water, oils, chemicals, and organic solvents
 - Use of our Products outdoors or in places where the Products are exposed to direct sunlight or dust
 - Use of our Products in places where the Products are exposed to sea wind or corrosive gases, including Cl₂, H₂S, NH₃, SO₂, and NO₂
 - Use of our Products in places where the Products are exposed to static electricity or electromagnetic waves
 - Use of our Products in proximity to heat-producing components, plastic cords, or other flammable items
 - Sealing or coating our Products with resin or other coating materials
 - Use of our Products without cleaning residue of flux (even if you use no-clean type fluxes, cleaning residue of flux is recommended); or Washing our Products by using water or water-soluble cleaning agents for cleaning residue after soldering
 - Use of the Products in places subject to dew condensation
- The Products are not subject to radiation-proof design.
- Please verify and confirm characteristics of the final or mounted products in using the Products.
- In particular, if a transient load (a large amount of load applied in a short period of time, such as pulse. is applied, confirmation of performance characteristics after on-board mounting is strongly recommended. Avoid applying power exceeding normal rated power; exceeding the power rating under steady-state loading condition may negatively affect product performance and reliability.
- De-rate Power Dissipation depending on ambient temperature. When used in sealed area, confirm that it is the use in the range that does not exceed the maximum junction temperature.
- Confirm that operation temperature is within the specified range described in the product specification.
- ROHM shall not be in any way responsible or liable for failure induced under deviant condition from what is defined in this document.

Precaution for Mounting / Circuit board design

- When a highly active halogenous (chlorine, bromine, etc.) flux is used, the residue of flux may negatively affect product performance and reliability.
- In principle, the reflow soldering method must be used on a surface-mount products, the flow soldering method must be used on a through hole mount products. If the flow soldering method is preferred on a surface-mount products, please consult with the ROHM representative in advance.

For details, please refer to ROHM Mounting specification

Precautions Regarding Application Examples and External Circuits

1. If change is made to the constant of an external circuit, please allow a sufficient margin considering variations of the characteristics of the Products and external components, including transient characteristics, as well as static characteristics.
2. You agree that application notes, reference designs, and associated data and information contained in this document are presented only as guidance for Products use. Therefore, in case you use such information, you are solely responsible for it and you must exercise your own independent verification and judgment in the use of such information contained in this document. ROHM shall not be in any way responsible or liable for any damages, expenses or losses incurred by you or third parties arising from the use of such information.

Precaution for Electrostatic

This Product is electrostatic sensitive product, which may be damaged due to electrostatic discharge. Please take proper caution in your manufacturing process and storage so that voltage exceeding the Products maximum rating will not be applied to Products. Please take special care under dry condition (e.g. Grounding of human body / equipment / solder iron, isolation from charged objects, setting of Ionizer, friction prevention and temperature / humidity control).

Precaution for Storage / Transportation

1. Product performance and soldered connections may deteriorate if the Products are stored in the places where:
 - [a] the Products are exposed to sea winds or corrosive gases, including Cl₂, H₂S, NH₃, SO₂, and NO₂
 - [b] the temperature or humidity exceeds those recommended by ROHM
 - [c] the Products are exposed to direct sunshine or condensation
 - [d] the Products are exposed to high Electrostatic
2. Even under ROHM recommended storage condition, solderability of products out of recommended storage time period may be degraded. It is strongly recommended to confirm solderability before using Products of which storage time is exceeding the recommended storage time period.
3. Store / transport cartons in the correct direction, which is indicated on a carton with a symbol. Otherwise bent leads may occur due to excessive stress applied when dropping of a carton.
4. Use Products within the specified time after opening a humidity barrier bag. Baking is required before using Products of which storage time is exceeding the recommended storage time period.

Precaution for Product Label

A two-dimensional barcode printed on ROHM Products label is for ROHM's internal use only.

Precaution for Disposition

When disposing Products please dispose them properly using an authorized industry waste company.

Precaution for Foreign Exchange and Foreign Trade act

Since concerned goods might be fallen under listed items of export control prescribed by Foreign exchange and Foreign trade act, please consult with ROHM in case of export.

Precaution Regarding Intellectual Property Rights

1. All information and data including but not limited to application example contained in this document is for reference only. ROHM does not warrant that foregoing information or data will not infringe any intellectual property rights or any other rights of any third party regarding such information or data.
2. ROHM shall not have any obligations where the claims, actions or demands arising from the combination of the Products with other articles such as components, circuits, systems or external equipment (including software).
3. No license, expressly or implied, is granted hereby under any intellectual property rights or other rights of ROHM or any third parties with respect to the Products or the information contained in this document. Provided, however, that ROHM will not assert its intellectual property rights or other rights against you or your customers to the extent necessary to manufacture or sell products containing the Products, subject to the terms and conditions herein.

Other Precaution

1. This document may not be reprinted or reproduced, in whole or in part, without prior written consent of ROHM.
2. The Products may not be disassembled, converted, modified, reproduced or otherwise changed without prior written consent of ROHM.
3. In no event shall you use in any way whatsoever the Products and the related technical information contained in the Products or this document for any military purposes, including but not limited to, the development of mass-destruction weapons.
4. The proper names of companies or products described in this document are trademarks or registered trademarks of ROHM, its affiliated companies or third parties.

General Precaution

1. Before you use our Products, you are requested to carefully read this document and fully understand its contents. ROHM shall not be in any way responsible or liable for failure, malfunction or accident arising from the use of any ROHM's Products against warning, caution or note contained in this document.
2. All information contained in this document is current as of the issuing date and subject to change without any prior notice. Before purchasing or using ROHM's Products, please confirm the latest information with a ROHM sales representative.
3. The information contained in this document is provided on an "as is" basis and ROHM does not warrant that all information contained in this document is accurate and/or error-free. ROHM shall not be in any way responsible or liable for any damages, expenses or losses incurred by you or third parties resulting from inaccuracy or errors of or concerning such information.



BD4721G - Web Page

[Distribution Inventory](#)

Part Number	BD4721G
Package	SSOP5
Unit Quantity	3000
Minimum Package Quantity	3000
Packing Type	Taping
Constitution Materials List	inquiry
RoHS	Yes