



Is Now Part of



**ON Semiconductor®**

To learn more about ON Semiconductor, please visit our website at  
[www.onsemi.com](http://www.onsemi.com)

ON Semiconductor and the ON Semiconductor logo are trademarks of Semiconductor Components Industries, LLC dba ON Semiconductor or its subsidiaries in the United States and/or other countries. ON Semiconductor owns the rights to a number of patents, trademarks, copyrights, trade secrets, and other intellectual property. A listing of ON Semiconductor's product/patent coverage may be accessed at [www.onsemi.com/site/pdf/Patent-Marking.pdf](http://www.onsemi.com/site/pdf/Patent-Marking.pdf). ON Semiconductor reserves the right to make changes without further notice to any products herein. ON Semiconductor makes no warranty, representation or guarantee regarding the suitability of its products for any particular purpose, nor does ON Semiconductor assume any liability arising out of the application or use of any product or circuit, and specifically disclaims any and all liability, including without limitation special, consequential or incidental damages. Buyer is responsible for its products and applications using ON Semiconductor products, including compliance with all laws, regulations and safety requirements or standards, regardless of any support or applications information provided by ON Semiconductor. "Typical" parameters which may be provided in ON Semiconductor data sheets and/or specifications can and do vary in different applications and actual performance may vary over time. All operating parameters, including "Typicals" must be validated for each customer application by customer's technical experts. ON Semiconductor does not convey any license under its patent rights nor the rights of others. ON Semiconductor products are not designed, intended, or authorized for use as a critical component in life support systems or any FDA Class 3 medical devices or medical devices with a same or similar classification in a foreign jurisdiction or any devices intended for implantation in the human body. Should Buyer purchase or use ON Semiconductor products for any such unintended or unauthorized application, Buyer shall indemnify and hold ON Semiconductor and its officers, employees, subsidiaries, affiliates, and distributors harmless against all claims, costs, damages, and expenses, and reasonable attorney fees arising out of, directly or indirectly, any claim of personal injury or death associated with such unintended or unauthorized use, even if such claim alleges that ON Semiconductor was negligent regarding the design or manufacture of the part. ON Semiconductor is an Equal Opportunity/Affirmative Action Employer. This literature is subject to all applicable copyright laws and is not for resale in any manner.

# NC7SZ00

## TinyLogic® UHS Two-Input NAND Gate

### Features

- Ultra-High Speed:  $t_{PD}$  2.4ns (Typical) into 50pF at 5V  $V_{CC}$
- High Output Drive:  $\pm 24$ mA at 3V  $V_{CC}$
- Broad  $V_{CC}$  Operating Range: 1.65V to 5.5V
- Matches Performance of LCX Operated at 3.3V  $V_{CC}$
- Power Down High-Impedance Inputs/Outputs
- Over-Voltage Tolerance inputs facilitate 5V to 3V Translation
- Proprietary Noise/EMI Reduction Circuitry
- Ultra-Small MicroPak™ Packages
- Space-Saving SOT23 and SC70 Packages

### Description

The NC7SZ00 is a single two-input NAND gate from Fairchild's Ultra-High Speed (UHS) series of TinyLogic®. The device is fabricated with advanced CMOS technology to achieve ultra-high speed with high output drive while maintaining low static power dissipation over a broad  $V_{CC}$  operating range. The device is specified to operate over the 1.65V to 5.5V  $V_{CC}$  operating range. The inputs and output are high impedance when  $V_{CC}$  is 0V. Inputs tolerate voltages up to 6V, independent of  $V_{CC}$  operating voltage.

### Related Resources

- [MS-503 — Family Characteristics TinyLogic® HS/HST and UHS Series](#)

### Ordering Information

Part Number	Top Mark	Package	Packing Method
NC7SZ00M5X	7Z00	5-Lead SOT23, JEDEC MO-178 1.6mm	3000 Units on Tape & Reel
NC7SZ00P5X	Z00	5-Lead SC70, EIAJ SC-88a, 1.25mm Wide	3000 Units on Tape & Reel
NC7SZ00L6X	YY	6-Lead MicroPak™, 1.00mm Wide	5000 Units on Tape & Reel
NC7SZ00FHX	YY	6-Lead, MicroPak2™, 1x1mm Body, .35mm Pitch	5000 Units on Tape & Reel

## Connection Diagrams

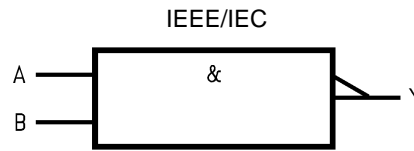

Figure 1. Logic Symbol

## Pin Configurations

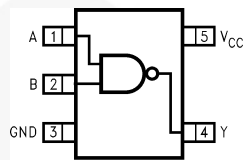

Figure 2. SC70 and SOT23 (Top View)

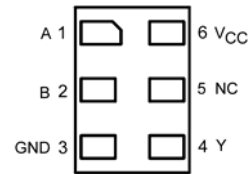

Figure 3. MicroPak™ (Top Through View)

## Pin Definitions

Pin # SC70 / SOT23	Pin # MicroPak™	Name	Description
1	1	A	Input
2	2	B	Input
3	3	GND	Ground
4	4	Y	Output
5	6	V <sub>CC</sub>	Supply Voltage
	5	NC	No Connect

## Function Table

Inputs		Output
A	B	Y
L	L	H
L	H	H
H	L	H
H	H	L

H = HIGH Logic Level

L = LOW Logic Level

## Absolute Maximum Ratings

Stresses exceeding the absolute maximum ratings may damage the device. The device may not function or be operable above the recommended operating conditions and stressing the parts to these levels is not recommended. In addition, extended exposure to stresses above the recommended operating conditions may affect device reliability. The absolute maximum ratings are stress ratings only.

Symbol	Parameter	Min.	Max.	Unit	
$V_{CC}$	Supply Voltage	-0.5	6.0	V	
$V_{IN}$	DC Input Voltage	-0.5	6.0	V	
$V_{OUT}$	DC Output Voltage	-0.5	6.0	V	
$I_{IK}$	DC Input Diode Current	$V_{IN} < -0.5V$		-50	mA
		$V_{IN} > 6.0V$		+20	
$I_{OK}$	DC Output Diode Current	$V_{OUT} < -0.5V$		-50	mA
		$V_{OUT} > 6V, V_{CC}=GND$		+20	
$I_{OUT}$	DC Output Current		±50	mA	
$I_{CC}$ or $I_{GND}$	DC $V_{CC}$ or Ground Current		±50	mA	
$T_{STG}$	Storage Temperature Range	-65	+150	°C	
$T_J$	Junction Temperature Under Bias		+150	°C	
$T_L$	Junction Lead Temperature (Soldering, 10 Seconds)		+260	°C	
$P_D$	Power Dissipation at +85°C	SOT-23		200	mW
		SC70-5		150	
		MicroPak™-6		130	
		MicroPak2™-6		120	
ESD	Human Body Model, JEDEC:JESD22-A114		4000	V	
	Charge Device Model, JEDEC:JESD22-C101		2000		

## Recommended Operating Conditions

The Recommended Operating Conditions table defines the conditions for actual device operation. Recommended operating conditions are specified to ensure optimal performance to the datasheet specifications. Fairchild does not recommend exceeding them or designing to Absolute Maximum Ratings.

Symbol	Parameter	Conditions	Min.	Max.	Unit
$V_{CC}$	Supply Voltage Operating		1.65	5.50	V
	Supply Voltage Data Retention		1.5	5.5	
$V_{IN}$	Input Voltage		0	5.5	V
$V_{OUT}$	Output Voltage		0	$V_{CC}$	V
$T_A$	Operating Temperature		-40	+85	°C
$t_r, t_f$	Input Rise and Fall Times	$V_{CC}$ at 1.8V, 2.5V ±0.2V	0	20	ns/V
		$V_{CC}$ at 3.3V ± 0.3V	0	10	
		$V_{CC}$ at 5.0V ± 0.5V	0	5	
$\theta_{JA}$	Thermal Resistance	SOT-23		300	°C/W
		SC70-5		435	
		MicroPak™-6		500	
		MicroPak2™-6		560	

**Note:**

- Unused inputs must be held HIGH or LOW. They may not float.

### DC Electrical Characteristics

Symbol	Parameter	V <sub>CC</sub>	Conditions	T <sub>A</sub> =25°C			T <sub>A</sub> =-40 to +85°C		Units
				Min.	Typ.	Max.	Min.	Max.	
V <sub>IH</sub>	HIGH Level Input Voltage	1.65 to 1.95		0.75V <sub>CC</sub>			0.75V <sub>CC</sub>		V
		2.30 to 5.50		0.70V <sub>CC</sub>			0.70V <sub>CC</sub>		
V <sub>IL</sub>	LOW Level Input Voltage	1.65 to 1.95				0.25V <sub>CC</sub>		0.25V <sub>CC</sub>	V
		2.30 to 5.50				0.30V <sub>CC</sub>		0.30V <sub>CC</sub>	
V <sub>OH</sub>	HIGH Level Output Voltage	1.65	V <sub>IN</sub> =V <sub>IL</sub> I <sub>OH</sub> =-100μA	1.55	1.65		1.55		V
		1.80		1.70	1.80		1.70		
		2.30		2.20	2.30		2.20		
		3.00		2.90	3.00		2.90		
		4.50		4.40	4.50		4.40		
		1.65	I <sub>OH</sub> =-4mA	1.29	1.52		1.29		
		1.80	I <sub>OH</sub> =-8mA	1.90	2.15		1.90		
		2.30	I <sub>OH</sub> =-16mA	2.40	2.80		2.40		
		3.00	I <sub>OH</sub> =-24mA	2.30	2.68		2.30		
		4.50	I <sub>OH</sub> =-32mA	3.80	4.20		3.80		
V <sub>OL</sub>	LOW Level Output Voltage	1.65	V <sub>IN</sub> =V <sub>IH</sub> I <sub>OL</sub> =100μA		0.00	0.10		0.08	V
		2.30			0.00	0.10		0.10	
		3.00			0.00	0.10		0.10	
		3.00			0.00	0.10		0.10	
		4.50			0.00	0.10		0.10	
		1.65	I <sub>OL</sub> =4mA		0.80	0.24		0.24	
		2.30	I <sub>OL</sub> =8mA		0.10	0.30		0.30	
		3.00	I <sub>OL</sub> =16mA		0.15	0.40		0.40	
		3.00	I <sub>OL</sub> =24mA		0.22	0.55		0.55	
		4.50	I <sub>OL</sub> =32mA		0.22	0.55		0.55	
I <sub>IN</sub>	Input Leakage Current	0 to 5.5	V <sub>IN</sub> =5.5V, GND			±1		±10	μA
I <sub>OFF</sub>	Power Off	0	V <sub>IN</sub> or V <sub>OUT</sub> =5.5V			1		10	μA
I <sub>CC</sub>	Quiescent Supply Current	1.65 to 5.50	V <sub>IN</sub> =5.5V, GND			2		20	μA

## AC Electrical Characteristics

Symbol	Parameter	V <sub>CC</sub>	Conditions	T <sub>A</sub> =25°C			T <sub>A</sub> =-40 to +85°C		Units	Figure
				Min.	Typ.	Max.	Min.	Max.		
t <sub>PHL</sub> , t <sub>PLH</sub>	Propagation Delay	1.65	C <sub>L</sub> =15pF, R <sub>L</sub> =1MΩ	2.0	5.4	11.4	2.0	12.0	ns	Figure 4 Figure 5
		1.80		2.0	4.5	9.5	2.0	10.0		
		2.50 ± 0.20		0.8	3.0	6.5	0.8	7.0		
		3.30 ± 0.30		0.5	2.4	4.5	0.5	4.7		
		5.00 ± 0.50		0.5	2.0	3.9	0.5	4.1		
		3.30 ± 0.30		C <sub>L</sub> =50pF, R <sub>L</sub> =500Ω	1.5	2.9	5.0	1.5		
5.00 ± 0.50	0.8	2.4	4.3		0.8	4.5				
C <sub>IN</sub>	Input Capacitance	0.00			4				pF	
C <sub>PD</sub>	Power Dissipation Capacitance <sup>(2)</sup>	3.30			24				pF	Figure 6
		5.00			30					

**Note:**

- C<sub>PD</sub> is defined as the value of the internal equivalent capacitance derived from dynamic operating current consumption (I<sub>CCD</sub>) at no output lading and operating at 50% duty cycle. C<sub>PD</sub> is related to I<sub>CCD</sub> dynamic operating current by the expression: I<sub>CCD</sub>=(C<sub>PD</sub>)(V<sub>CC</sub>)(f<sub>IN</sub>)+(I<sub>CC</sub>static).

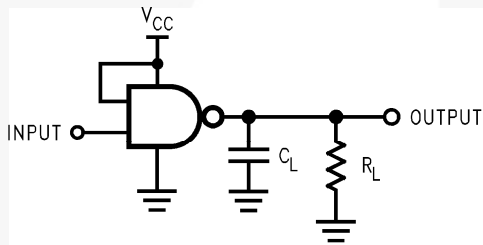

Figure 4. AC Test Circuit

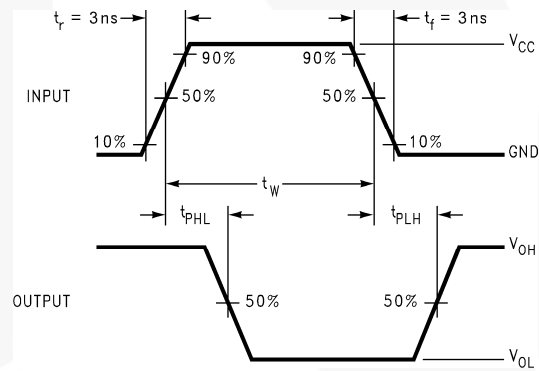
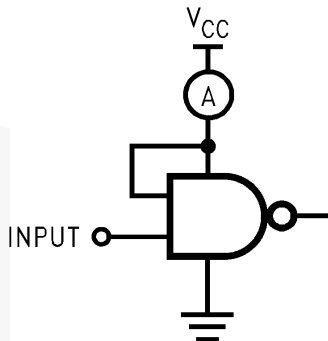

Figure 5. AC Waveforms



**Note:**

- Input=AC Waveform; t<sub>r</sub>=t<sub>f</sub>=1.8ns; PRR=10MHz; Duty Cycle =50%.

Figure 6. I<sub>CCD</sub> Test Circuit

## Physical Dimensions

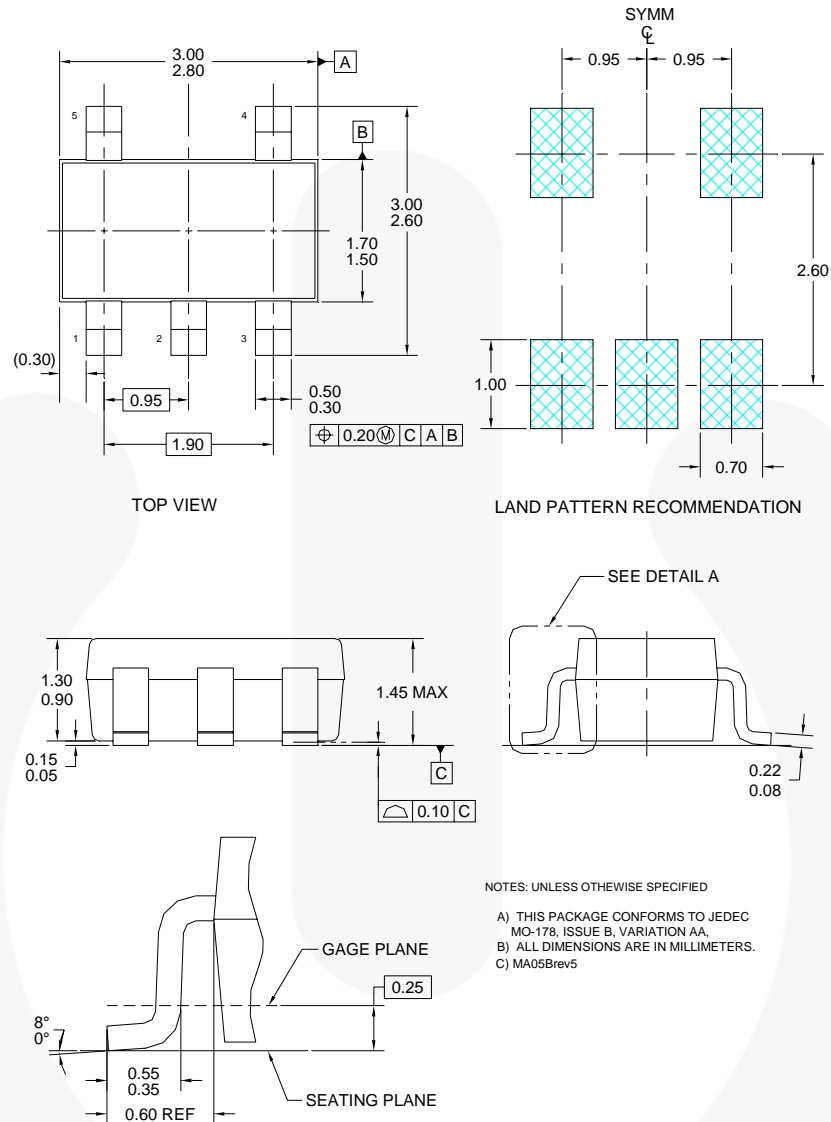

**Figure 7. 5-Lead SOT23, JEDEC MO-178 1.6mm**

Package drawings are provided as a service to customers considering Fairchild components. Drawings may change in any manner without notice. Please note the revision and/or date on the drawing and contact a Fairchild Semiconductor representative to verify or obtain the most recent revision. Package specifications do not expand the terms of Fairchild's worldwide terms and conditions, specifically the warranty therein, which covers Fairchild products.

Always visit Fairchild Semiconductor's online packaging area for the most recent package drawings:  
<http://www.fairchildsemi.com/packaging/>.

## Tape and Reel Specifications

Please visit Fairchild Semiconductor's online packaging area for the most recent tape and reel specifications:  
[http://www.fairchildsemi.com/packaging/SOT23-5L\\_tr.pdf](http://www.fairchildsemi.com/packaging/SOT23-5L_tr.pdf).

Package Designator	Tape Section	Cavity Number	Cavity Status	Cover Type Status
M5X	Leader (Start End)	125 (Typical)	Empty	Sealed
	Carrier	3000	Filled	Sealed
	Trailer (Hub End)	75 (Typical)	Empty	Sealed

## Physical Dimensions

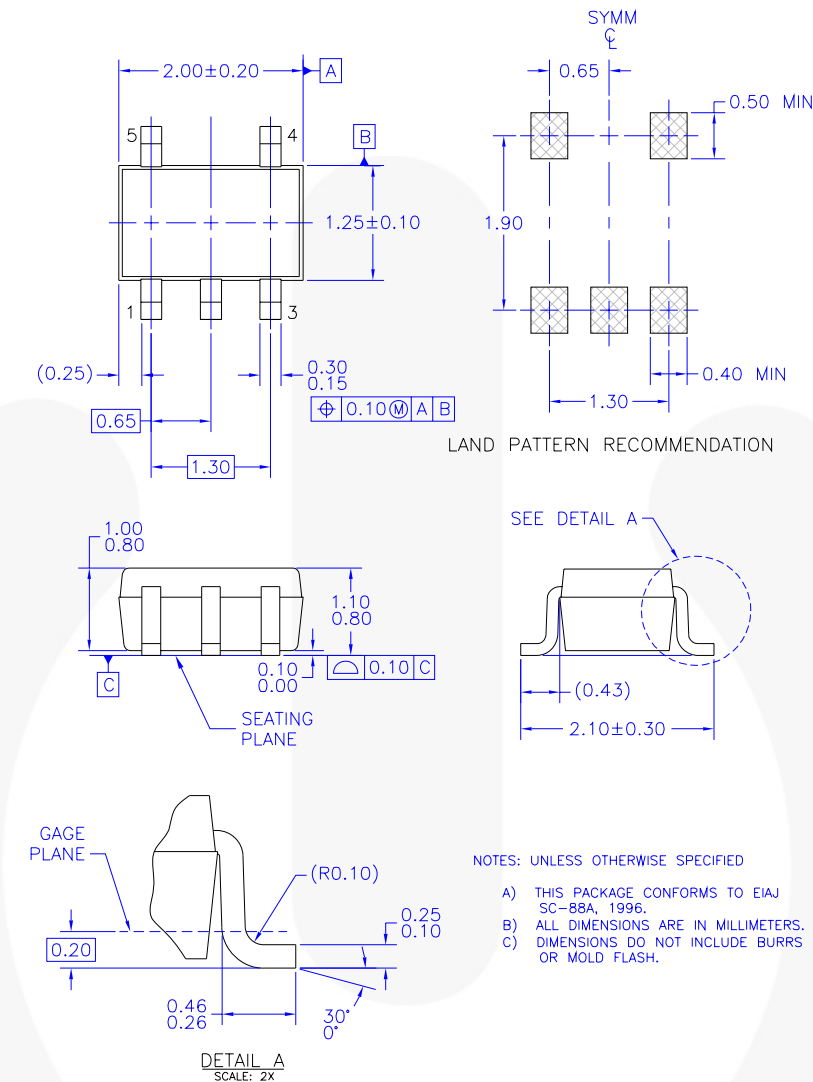

MAA05AREV5

**Figure 8. 5-Lead, SC70, EIAJ SC-88a, 1.25mm Wide**

Package drawings are provided as a service to customers considering Fairchild components. Drawings may change in any manner without notice. Please note the revision and/or date on the drawing and contact a Fairchild Semiconductor representative to verify or obtain the most recent revision. Package specifications do not expand the terms of Fairchild's worldwide terms and conditions, specifically the warranty therein, which covers Fairchild products.

Always visit Fairchild Semiconductor's online packaging area for the most recent package drawings:  
<http://www.fairchildsemi.com/packaging/>

## Tape and Reel Specifications

Please visit Fairchild Semiconductor's online packaging area for the most recent tape and reel specifications:  
[http://www.fairchildsemi.com/products/analog/pdf/sc70-5\\_tr.pdf](http://www.fairchildsemi.com/products/analog/pdf/sc70-5_tr.pdf)

Package Designator	Tape Section	Cavity Number	Cavity Status	Cover Type Status
P5X	Leader (Start End)	125 (Typical)	Empty	Sealed
	Carrier	3000	Filled	Sealed
	Trailer (Hub End)	75 (Typical)	Empty	Sealed



## Physical Dimensions

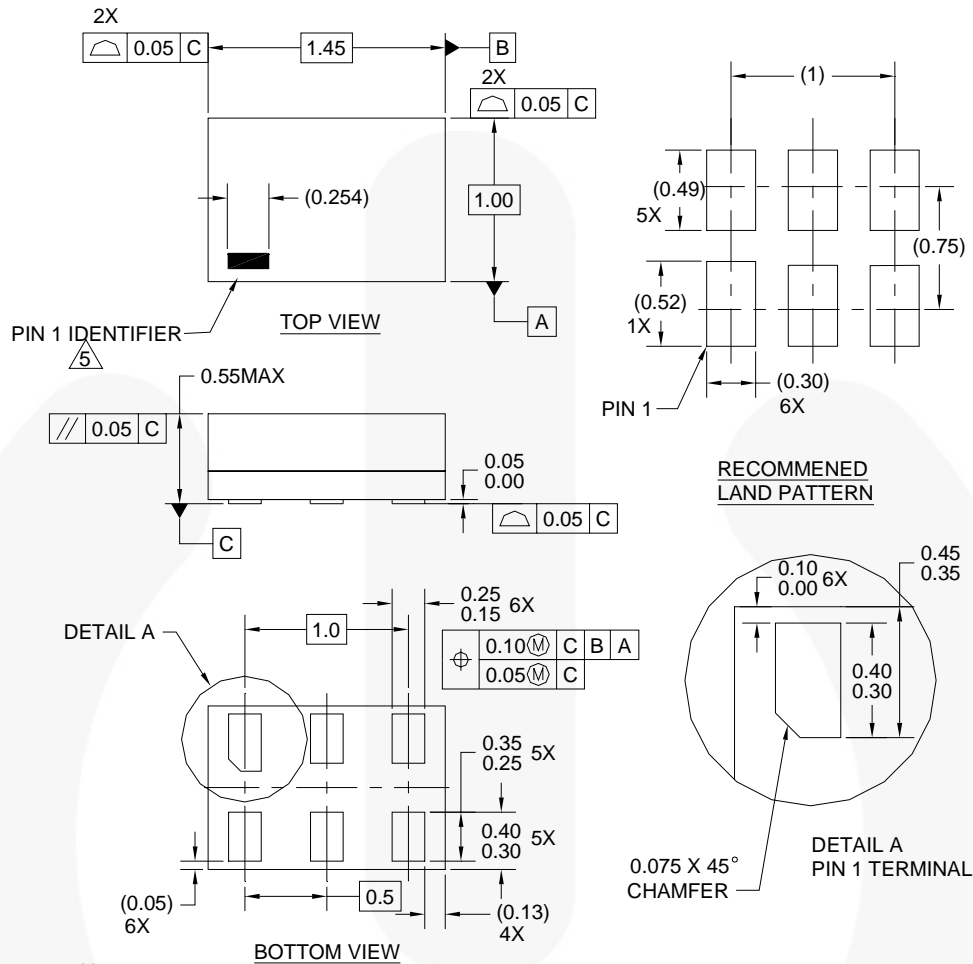

**Notes:**

1. CONFORMS TO JEDEC STANDARD M0-252 VARIATION UAAD
2. DIMENSIONS ARE IN MILLIMETERS
3. DRAWING CONFORMS TO ASME Y14.5M-1994
4. FILENAME AND REVISION: MAC06AREV4
5. PIN ONE IDENTIFIER IS 2X LENGTH OF ANY OTHER LINE IN THE MARK CODE LAYOUT.

**Figure 9. 6-Lead, MicroPak™, 1.0mm Wide**

Package drawings are provided as a service to customers considering Fairchild components. Drawings may change in any manner without notice. Please note the revision and/or date on the drawing and contact a Fairchild Semiconductor representative to verify or obtain the most recent revision. Package specifications do not expand the terms of Fairchild's worldwide terms and conditions, specifically the warranty therein, which covers Fairchild products.

Always visit Fairchild Semiconductor's online packaging area for the most recent package drawings:  
<http://www.fairchildsemi.com/packaging/>

## Tape and Reel Specifications

Please visit Fairchild Semiconductor's online packaging area for the most recent tape and reel specifications:  
[http://www.fairchildsemi.com/products/logic/pdf/micropak\\_tr.pdf](http://www.fairchildsemi.com/products/logic/pdf/micropak_tr.pdf)

Package Designator	Tape Section	Cavity Number	Cavity Status	Cover Type Status
L6X	Leader (Start End)	125 (Typical)	Empty	Sealed
	Carrier	5000	Filled	Sealed
	Trailer (Hub End)	75 (Typical)	Empty	Sealed

## Physical Dimensions

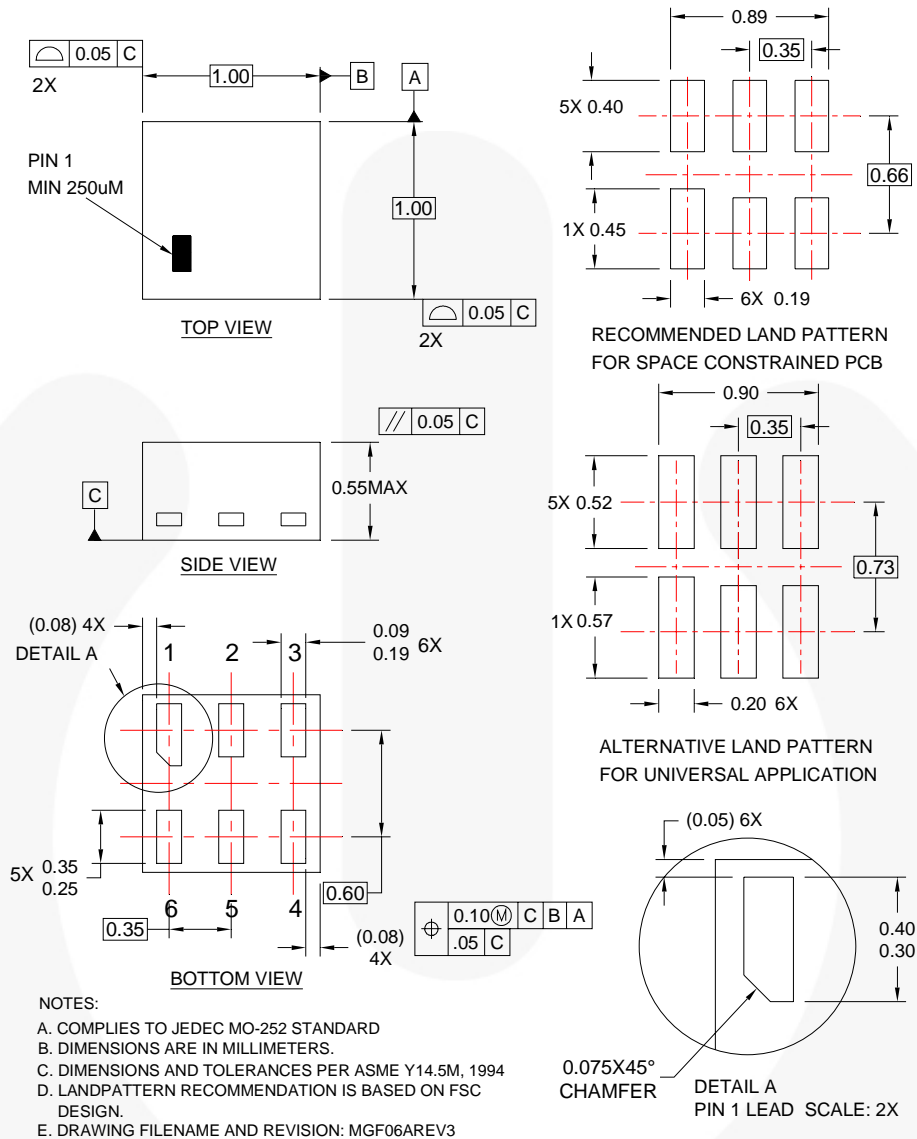

**Figure 10. 6-Lead, MicroPak2, 1x1mm Body, .35mm Pitch**

Package drawings are provided as a service to customers considering Fairchild components. Drawings may change in any manner without notice. Please note the revision and/or date on the drawing and contact a Fairchild Semiconductor representative to verify or obtain the most recent revision. Package specifications do not expand the terms of Fairchild's worldwide terms and conditions, specifically the warranty therein, which covers Fairchild products.

Always visit Fairchild Semiconductor's online packaging area for the most recent package drawings:  
<http://www.fairchildsemi.com/packaging/>

## Tape and Reel Specifications





Please visit Fairchild Semiconductor's online packaging area for the most recent tape and reel specifications:  
[http://www.fairchildsemi.com/packaging/MicroPAK2\\_6L\\_tr.pdf](http://www.fairchildsemi.com/packaging/MicroPAK2_6L_tr.pdf)

Package Designator	Tape Section	Cavity Number	Cavity Status	Cover Type Status
FHX	Leader (Start End)	125 (Typical)	Empty	Sealed
	Carrier	5000	Filled	Sealed
	Trailer (Hub End)	75 (Typical)	Empty	Sealed



**TRADEMARKS**

The following includes registered and unregistered trademarks and service marks, owned by Fairchild Semiconductor and/or its global subsidiaries, and is not intended to be an exhaustive list of all such trademarks.

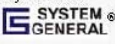
- |                                                                                              |                                                                                            |                                                                                                                       |                                                                                             |
|----------------------------------------------------------------------------------------------|--------------------------------------------------------------------------------------------|-----------------------------------------------------------------------------------------------------------------------|---------------------------------------------------------------------------------------------|
| AccuPower™                                                                                   | F-PFS™                                                                                     | Power-SPM™                                                                                                            | The Power Franchise®                                                                        |
| Auto-SPM™                                                                                    | FRFET®                                                                                     | PowerTrench®                                                                                                          | The Right Technology for Your Success™                                                      |
| AX-CAPT™                                                                                     | Global Power Resource™                                                                     | PowerXS™                                                                                                              | <b>the power franchise</b>                                                                  |
| Build it Now™                                                                                | Green FPST™                                                                                | Programmable Active Droop™                                                                                            | TinyBoost™                                                                                  |
| CorePLUS™                                                                                    | Green FPST™ e-Series™                                                                      | QFET®                                                                                                                 | TinyBuck™                                                                                   |
| CorePOWER™                                                                                   | Gmax™                                                                                      | QST™                                                                                                                  | TinyCalc™                                                                                   |
| CROSSVOL7™                                                                                   | GTO™                                                                                       | Quiet Series™                                                                                                         | TinyLogic®                                                                                  |
| CTL™                                                                                         | IntelliMAX™                                                                                | RapidConfigure™                                                                                                       | TINYOPTO™                                                                                   |
| Current Transfer Logic™                                                                      | ISOPLANAR™                                                                                 |  Saving our world, 1mW/kW at a time™ | TinyPower™                                                                                  |
| DEUXPEED®                                                                                    | MegaBuck™                                                                                  | SignalWise™                                                                                                           | TinyPWM™                                                                                    |
| Dual Cool™                                                                                   | MICROCOUPLER™                                                                              | SmartMax™                                                                                                             | TinyWire™                                                                                   |
| EcoSPARK®                                                                                    | MicroFET™                                                                                  | SMART START™                                                                                                          | TriFault Detect™                                                                            |
| EfficientMax™                                                                                | MicroPak™                                                                                  | SPM®                                                                                                                  | TRUECURRENT™                                                                                |
| ESBCT™                                                                                       | MicroPak2™                                                                                 | STEALTH™                                                                                                              | µSerDes™                                                                                    |
|  Fairchild® | MillerDrive™                                                                               | SuperFET®                                                                                                             |  SerDes® |
| Fairchild Semiconductor®                                                                     | MotionMax™                                                                                 | SuperSOT™.3                                                                                                           | UHC®                                                                                        |
| FACT Quiet Series™                                                                           | Motion-SPM™                                                                                | SuperSOT™.8                                                                                                           | Ultra FRFET™                                                                                |
| FACT®                                                                                        | mWSaver™                                                                                   | SuperSOT™.8                                                                                                           | UniFET™                                                                                     |
| FAST®                                                                                        | OptoHIT™                                                                                   | SupreMOS®                                                                                                             | VCM™                                                                                        |
| FastvCore™                                                                                   | OPTOLOGIC®                                                                                 | SyncFET™                                                                                                              | VisualMax™                                                                                  |
| FETBench™                                                                                    | OPTOPLANAR®                                                                                | Sync-Lock™                                                                                                            | XS™                                                                                         |
| FlashWriter®                                                                                 |  PDP SPM™ |  SYSTEM GENERAL®                     |                                                                                             |
| FPST™                                                                                        |                                                                                            |                                                                                                                       |                                                                                             |

\* Trademarks of System General Corporation, used under license by Fairchild Semiconductor.

**DISCLAIMER**

FAIRCHILD SEMICONDUCTOR RESERVES THE RIGHT TO MAKE CHANGES WITHOUT FURTHER NOTICE TO ANY PRODUCTS HEREIN TO IMPROVE RELIABILITY, FUNCTION, OR DESIGN. FAIRCHILD DOES NOT ASSUME ANY LIABILITY ARISING OUT OF THE APPLICATION OR USE OF ANY PRODUCT OR CIRCUIT DESCRIBED HEREIN; NEITHER DOES IT CONVEY ANY LICENSE UNDER ITS PATENT RIGHTS, NOR THE RIGHTS OF OTHERS. THESE SPECIFICATIONS DO NOT EXPAND THE TERMS OF FAIRCHILD'S WORLDWIDE TERMS AND CONDITIONS, SPECIFICALLY THE WARRANTY THEREIN, WHICH COVERS THESE PRODUCTS.

**LIFE SUPPORT POLICY**

FAIRCHILD'S PRODUCTS ARE NOT AUTHORIZED FOR USE AS CRITICAL COMPONENTS IN LIFE SUPPORT DEVICES OR SYSTEMS WITHOUT THE EXPRESS WRITTEN APPROVAL OF FAIRCHILD SEMICONDUCTOR CORPORATION.

As used herein:

1. Life support devices or systems are devices or systems which, (a) are intended for surgical implant into the body or (b) support or sustain life, and (c) whose failure to perform when properly used in accordance with instructions for use provided in the labeling, can be reasonably expected to result in a significant injury of the user.
2. A critical component in any component of a life support, device, or system whose failure to perform can be reasonably expected to cause the failure of the life support device or system, or to affect its safety or effectiveness.

**ANTI-COUNTERFEITING POLICY**

Fairchild Semiconductor Corporation's Anti-Counterfeiting Policy. Fairchild's Anti-Counterfeiting Policy is also stated on our external website, [www.fairchildsemi.com](http://www.fairchildsemi.com), under Sales Support.

Counterfeiting of semiconductor parts is a growing problem in the industry. All manufacturers of semiconductor products are experiencing counterfeiting of their parts. Customers who inadvertently purchase counterfeit parts experience many problems such as loss of brand reputation, substandard performance, failed applications, and increased cost of production and manufacturing delays. Fairchild is taking strong measures to protect ourselves and our customers from the proliferation of counterfeit parts. Fairchild strongly encourages customers to purchase Fairchild parts either directly from Fairchild or from Authorized Fairchild Distributors who are listed by country on our web page cited above. Products customers buy either from Fairchild directly or from Authorized Fairchild Distributors are genuine parts, have full traceability, meet Fairchild's quality standards for handling and storage and provide access to Fairchild's full range of up-to-date technical and product information. Fairchild and our Authorized Distributors will stand behind all warranties and will appropriately address any warranty issues that may arise. Fairchild will not provide any warranty coverage or other assistance for parts bought from Unauthorized Sources. Fairchild is committed to combat this global problem and encourage our customers to do their part in stopping this practice by buying direct or from authorized distributors.

**PRODUCT STATUS DEFINITIONS**

**Definition of Terms**

Datasheet Identification	Product Status	Definition
Advance Information	Formative / In Design	Datasheet contains the design specifications for product development. Specifications may change in any manner without notice.
Preliminary	First Production	Datasheet contains preliminary data; supplementary data will be published at a later date. Fairchild Semiconductor reserves the right to make changes at any time without notice to improve design.
No Identification Needed	Full Production	Datasheet contains final specifications. Fairchild Semiconductor reserves the right to make changes at any time without notice to improve the design.
Obsolete	Not In Production	Datasheet contains specifications on a product that is discontinued by Fairchild Semiconductor. The datasheet is for reference information only.

Rev. 152

ON Semiconductor and  are trademarks of Semiconductor Components Industries, LLC dba ON Semiconductor or its subsidiaries in the United States and/or other countries. ON Semiconductor owns the rights to a number of patents, trademarks, copyrights, trade secrets, and other intellectual property. A listing of ON Semiconductor's product/patent coverage may be accessed at [www.onsemi.com/site/pdf/Patent-Marking.pdf](http://www.onsemi.com/site/pdf/Patent-Marking.pdf). ON Semiconductor reserves the right to make changes without further notice to any products herein. ON Semiconductor makes no warranty, representation or guarantee regarding the suitability of its products for any particular purpose, nor does ON Semiconductor assume any liability arising out of the application or use of any product or circuit, and specifically disclaims any and all liability, including without limitation special, consequential or incidental damages. Buyer is responsible for its products and applications using ON Semiconductor products, including compliance with all laws, regulations and safety requirements or standards, regardless of any support or applications information provided by ON Semiconductor. "Typical" parameters which may be provided in ON Semiconductor data sheets and/or specifications can and do vary in different applications and actual performance may vary over time. All operating parameters, including "Typicals" must be validated for each customer application by customer's technical experts. ON Semiconductor does not convey any license under its patent rights nor the rights of others. ON Semiconductor products are not designed, intended, or authorized for use as a critical component in life support systems or any FDA Class 3 medical devices or medical devices with a same or similar classification in a foreign jurisdiction or any devices intended for implantation in the human body. Should Buyer purchase or use ON Semiconductor products for any such unintended or unauthorized application, Buyer shall indemnify and hold ON Semiconductor and its officers, employees, subsidiaries, affiliates, and distributors harmless against all claims, costs, damages, and expenses, and reasonable attorney fees arising out of, directly or indirectly, any claim of personal injury or death associated with such unintended or unauthorized use, even if such claim alleges that ON Semiconductor was negligent regarding the design or manufacture of the part. ON Semiconductor is an Equal Opportunity/Affirmative Action Employer. This literature is subject to all applicable copyright laws and is not for resale in any manner.

## PUBLICATION ORDERING INFORMATION

### LITERATURE FULFILLMENT:

Literature Distribution Center for ON Semiconductor  
19521 E. 32nd Pkwy, Aurora, Colorado 80011 USA  
**Phone:** 303-675-2175 or 800-344-3860 Toll Free USA/Canada  
**Fax:** 303-675-2176 or 800-344-3867 Toll Free USA/Canada  
**Email:** [orderlit@onsemi.com](mailto:orderlit@onsemi.com)

**N. American Technical Support:** 800-282-9855 Toll Free  
USA/Canada  
**Europe, Middle East and Africa Technical Support:**  
Phone: 421 33 790 2910  
**Japan Customer Focus Center**  
Phone: 81-3-5817-1050

**ON Semiconductor Website:** [www.onsemi.com](http://www.onsemi.com)  
**Order Literature:** <http://www.onsemi.com/orderlit>  
For additional information, please contact your local  
Sales Representative