



Is Now Part of



ON Semiconductor®

To learn more about ON Semiconductor, please visit our website at
www.onsemi.com

ON Semiconductor and the ON Semiconductor logo are trademarks of Semiconductor Components Industries, LLC dba ON Semiconductor or its subsidiaries in the United States and/or other countries. ON Semiconductor owns the rights to a number of patents, trademarks, copyrights, trade secrets, and other intellectual property. A listing of ON Semiconductor's product/patent coverage may be accessed at www.onsemi.com/site/pdf/Patent-Marking.pdf. ON Semiconductor reserves the right to make changes without further notice to any products herein. ON Semiconductor makes no warranty, representation or guarantee regarding the suitability of its products for any particular purpose, nor does ON Semiconductor assume any liability arising out of the application or use of any product or circuit, and specifically disclaims any and all liability, including without limitation special, consequential or incidental damages. Buyer is responsible for its products and applications using ON Semiconductor products, including compliance with all laws, regulations and safety requirements or standards, regardless of any support or applications information provided by ON Semiconductor. "Typical" parameters which may be provided in ON Semiconductor data sheets and/or specifications can and do vary in different applications and actual performance may vary over time. All operating parameters, including "Typicals" must be validated for each customer application by customer's technical experts. ON Semiconductor does not convey any license under its patent rights nor the rights of others. ON Semiconductor products are not designed, intended, or authorized for use as a critical component in life support systems or any FDA Class 3 medical devices or medical devices with a same or similar classification in a foreign jurisdiction or any devices intended for implantation in the human body. Should Buyer purchase or use ON Semiconductor products for any such unintended or unauthorized application, Buyer shall indemnify and hold ON Semiconductor and its officers, employees, subsidiaries, affiliates, and distributors harmless against all claims, costs, damages, and expenses, and reasonable attorney fees arising out of, directly or indirectly, any claim of personal injury or death associated with such unintended or unauthorized use, even if such claim alleges that ON Semiconductor was negligent regarding the design or manufacture of the part. ON Semiconductor is an Equal Opportunity/Affirmative Action Employer. This literature is subject to all applicable copyright laws and is not for resale in any manner.



FAN7601B

Green Current Mode PWM Controller

Features

- Green Current Mode PWM Control
- Low Operating Current: Maximum 4 mA
- Burst Mode Operation
- Internal High-Voltage Startup Switch
- Under-Voltage Lockout (UVLO): 12 V / 8 V
- Latch Protection and Soft-Start Function
- Over-Voltage Protection: 19 V
- Operating Frequency up to 300 kHz
- Maximum Duty Cycle: 95%

Applications

- Offline Adapter Applications
- Auxiliary Power Supplies

Related Resources

- [AN4129 — Green Current Mode PWM Controller FAN7601](#)

Description

The FAN7601B is a programmable frequency green current mode PWM controller. It is specially designed for the offline adapter applications and the auxiliary power supplies that require high efficiency at light load and no load. The internal high-voltage startup switch and burst mode reduce the power loss.

FAN7601B includes protections, such as latch protection and over-voltage protection. The latch protection can be used for over-voltage protection, thermal protection, and others. The soft-start prevents the output voltage overshoot at startup.

Ordering Information

Part Number	Operating Junction Temperature	Top Mark	Package	Packing Method
FAN7601BMX	-40°C to +150°C	7601B	8-SOP	Tape & Reel

Block Diagram

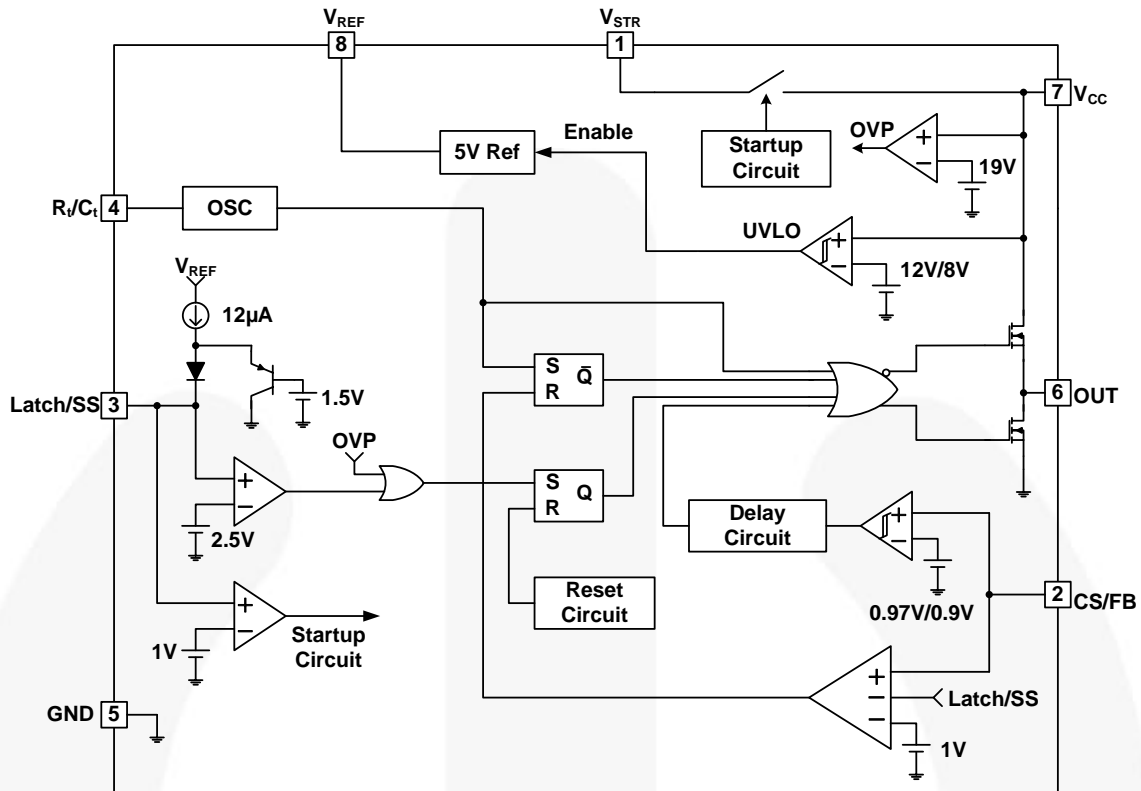

Figure 1. Internal Block Diagram

Pin Configuration

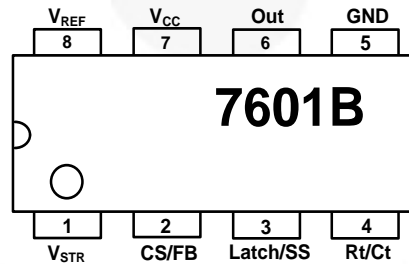

Figure 2. Pin Assignments (Top View)

Pin Definitions

Pin # (8-Pin)	Name	Description
1	V_{STR}	Startup
2	CS/FB	Current Sense and Feedback
3	Latch/SS	Latch Protection and Soft-Start
4	Rt/Ct	Oscillator Timing
5	GND	Ground
6	Out	Gate Drive Output
7	V_{CC}	IC Power Supply
8	V_{REF}	Voltage Reference

Absolute Maximum Ratings

Stresses exceeding the absolute maximum ratings may damage the device. The device may not function or be operable above the recommended operating conditions and stressing the parts to these levels is not recommended. In addition, extended exposure to stresses above the recommended operating conditions may affect device reliability. The absolute maximum ratings are stress ratings only.

Symbol	Parameter		Min.	Max.	Unit
V_{CC}	Supply Voltage			20	V
$V_{CS/FB}$	Input Voltage CS/FB		-0.3	20.0	V
T_{STG}	Storage Temperature		-55	+150	°C
T_J	Recommended Operating Junction Temperature		-40	+150	°C
I_O	Output Current			250	mA
V_{STR}	V_{STR} Input Voltage			500	V
ESD	Electrostatic Discharge Capability	Human Body Model, JESD22-A114		2000	V
		Charged Device Model, JESD22-C101		1500	

Thermal Impedance

Symbol	Parameter	Value	Unit
θ_{JA}	Thermal Resistance, Junction-to-Ambient	180	°C/W

Electrical Characteristics

$T_A = -25^{\circ}\text{C} \sim 125^{\circ}\text{C}$, $V_{CC} = 14\text{ V}$, $R_T = 9.5\text{ k}\Omega$, $C_T = 2.2\text{ nF}$ unless otherwise specified.

Symbol	Parameter	Conditions	Min.	Typ.	Max.	Unit
Reference Section						
V_{REF}	Reference Output Voltage	$I_O = 1\text{ mA}$	4.85	5.00	5.15	V
ΔV_{REF1}	Line Regulation	$V_{CC} = 10\text{ V} \sim 18\text{ V}$		10	20	mV
ΔV_{REF2}	Load Regulation	$I_O = 1\text{ mA} \sim 10\text{ mA}$		20	30	mV
Oscillator Section						
f_{OSC}	Initial Accuracy		90	100	110	kHz
ST_V	Voltage Stability	$V_{CC} = 10\text{ V} \sim 18\text{ V}$		1.0	1.5	%
V_{OSC}	Amplitude	V_{pin4} peak-to-peak		1.25		V
PWM Section						
$V_{CS/FB1}$	CS/FB Threshold Voltage1		0.9	1.0	1.1	V
D_{MAX}	Maximum Duty Cycle	$T_A = 25^{\circ}\text{C}$	92	95	98	%
D_{MIN}	Minimum Duty Cycle				0	%
Burst Mode Section						
$V_{CS/FB2}$	CS/FB Threshold Voltage2 ⁽¹⁾		0.77	0.97	1.17	V
$V_{CS/FB3}$	CS/FB Threshold Voltage3 ⁽¹⁾		0.7	0.9	1.1	V
Soft-Start Section						
I_{SS}	Soft-Start Current	$V_{pin3} = \text{GND}$	9	12	15	μA
V_{SL}	Soft-Start Limit Voltage ⁽²⁾	$I_{SS} = 1\text{ }\mu\text{A}$	1.2	1.5	1.8	V
Protection Section						
V_{LATCH}	Latch Voltage		2.25	2.50	2.75	V
V_{OVP}	Over-Voltage Protection		18	19	20	V
UVLO Section						
V_{TH}	Start Threshold Voltage		11	12	13	V
V_{TL}	Minimum Operating Voltage		7	8	9	V
Total Current Section						
I_{OP}	Operating Supply Current			3	4	mA
Output Section						
V_{OL}	Low Output Voltage	$T_A = 25^{\circ}\text{C}$, $I_O = 100\text{ mA}$		2.0	2.5	V
V_{OH}	High Output Voltage	$T_A = 25^{\circ}\text{C}$, $I_O = -100\text{ mA}$	11.5	12.0	14.0	V
t_r	Rising Time ⁽¹⁾	$T_A = 25^{\circ}\text{C}$, $C_I = 1\text{ nF}$		45	150	ns
t_f	Falling Time ⁽¹⁾	$T_A = 25^{\circ}\text{C}$, $C_I = 1\text{ nF}$		35	150	ns
Startup Section						
I_{STR}	V_{STR} Startup Current	$V_{STR} = 30\text{ V}$, $T_A = 25^{\circ}\text{C}$	0.5	1.0	1.5	mA

Notes:

- These parameters, although guaranteed, are not 100% tested in production.
- It is recommended to connect a 1 M Ω resistor between the Latch/SS pin and GND to prevent abnormal operation of the latch protection by noise coupling.

Typical Performance Characteristics

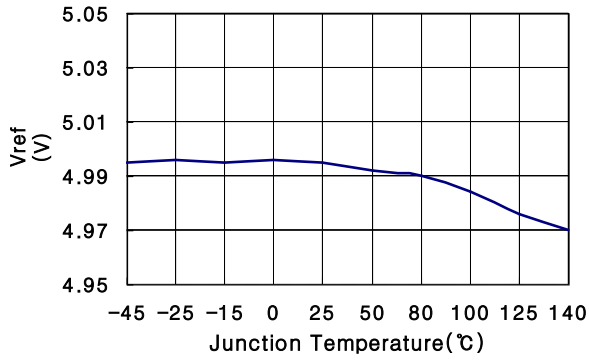

Figure 3. Trimmed Reference Voltage

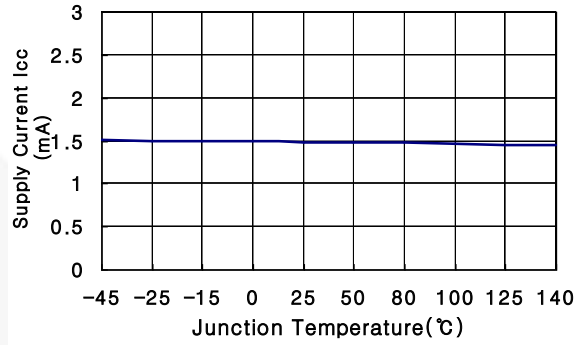

Figure 4. Supply Current

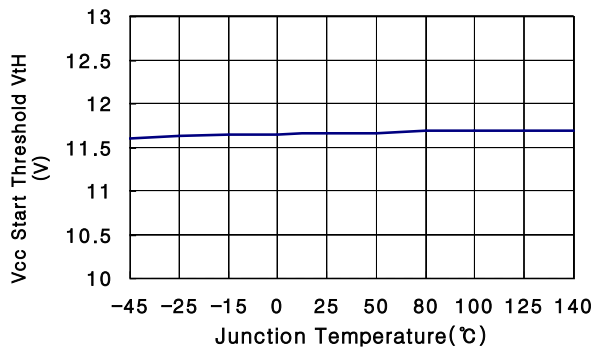

Figure 5. V_{CC} Start Threshold Voltage

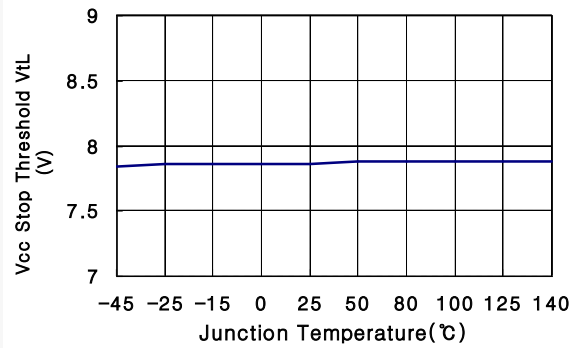

Figure 6. V_{CC} Stop Threshold Voltage

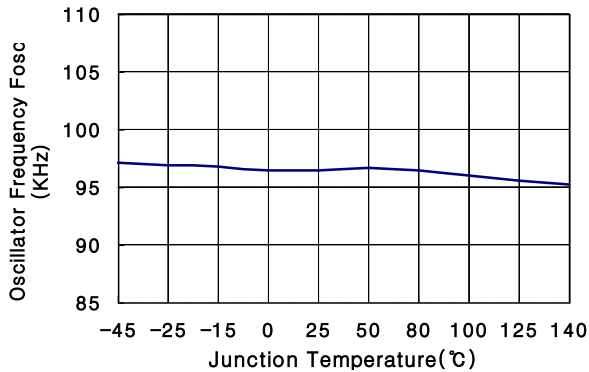

Figure 7. Oscillator Frequency

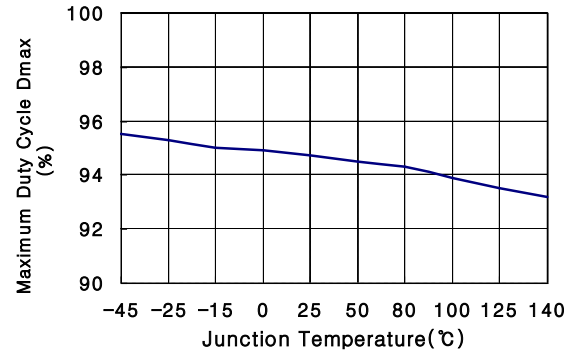

Figure 8. Maximum Duty Cycle

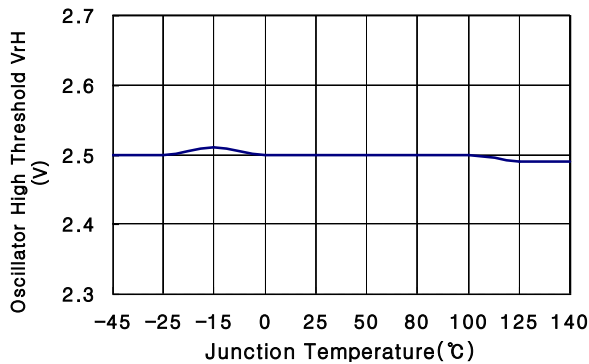

Figure 9. Oscillator High Threshold Voltage

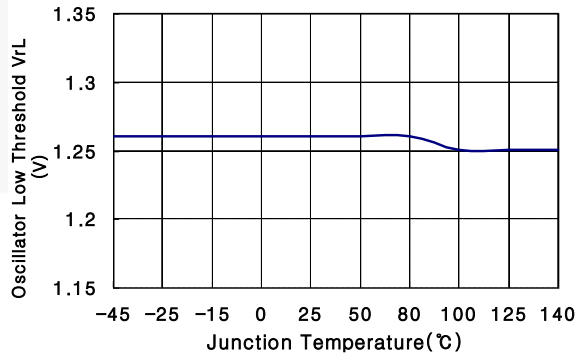

Figure 10. Oscillator Low Threshold Voltage

Typical Performance Characteristics (Continued)

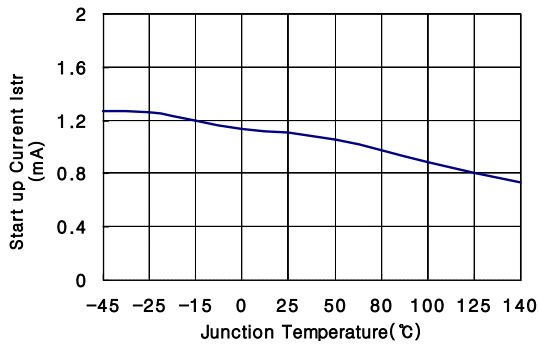

Figure 11. Startup Current

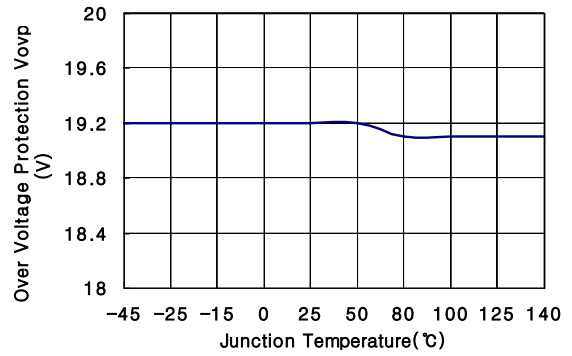

Figure 12. Over-Voltage Protection Level

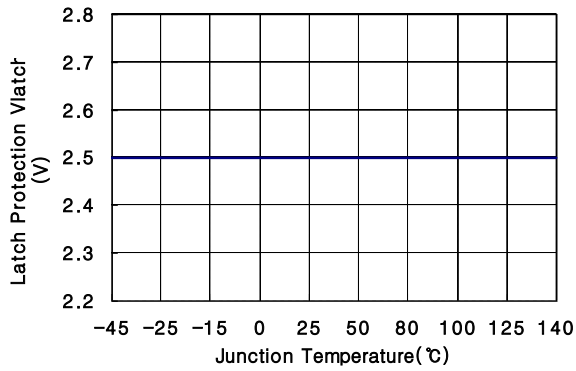

Figure 13. Latch Protection Voltage

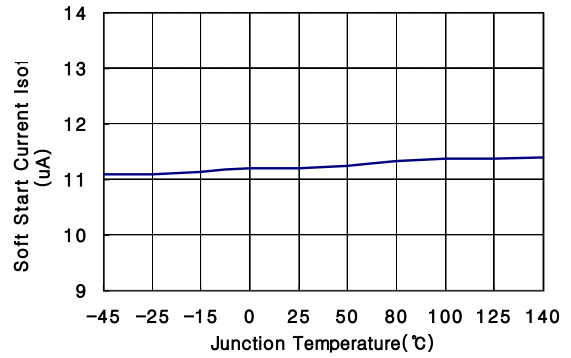

Figure 14. Soft-Start Current

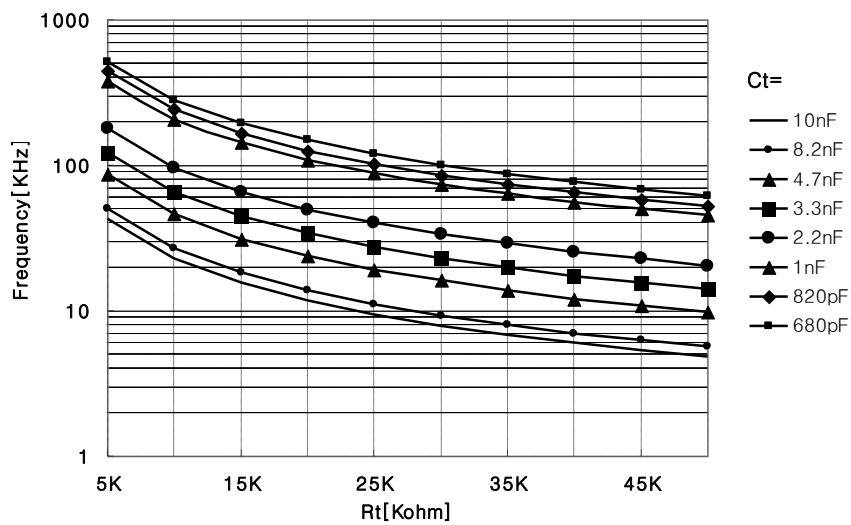
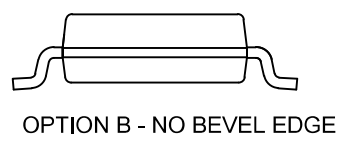
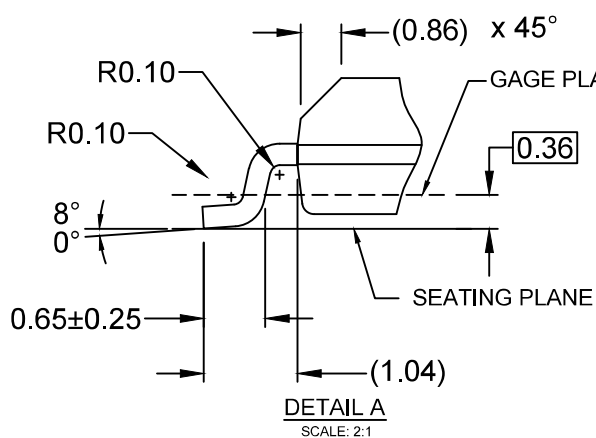
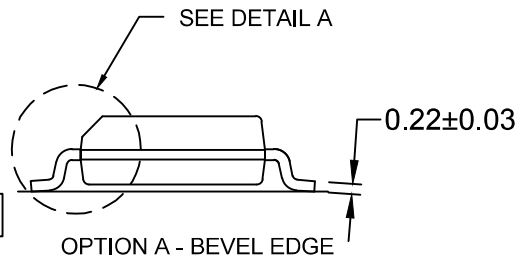
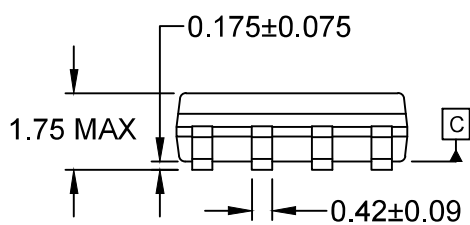
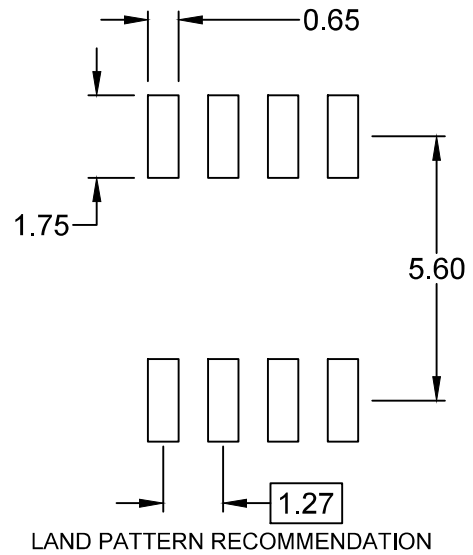

Figure 15. Oscillator Frequency Characteristic



- NOTES:
- A) THIS PACKAGE CONFORMS TO JEDEC MS-012, VARIATION AA.
 - B) ALL DIMENSIONS ARE IN MILLIMETERS.
 - C) DIMENSIONS DO NOT INCLUDE MOLD FLASH OR BURRS.
 - D) LANDPATTERN STANDARD: SOIC127P600X175-8M
 - E) DRAWING FILENAME: M08Arev16



ON Semiconductor and  are trademarks of Semiconductor Components Industries, LLC dba ON Semiconductor or its subsidiaries in the United States and/or other countries. ON Semiconductor owns the rights to a number of patents, trademarks, copyrights, trade secrets, and other intellectual property. A listing of ON Semiconductor's product/patent coverage may be accessed at www.onsemi.com/site/pdf/Patent-Marking.pdf. ON Semiconductor reserves the right to make changes without further notice to any products herein. ON Semiconductor makes no warranty, representation or guarantee regarding the suitability of its products for any particular purpose, nor does ON Semiconductor assume any liability arising out of the application or use of any product or circuit, and specifically disclaims any and all liability, including without limitation special, consequential or incidental damages. Buyer is responsible for its products and applications using ON Semiconductor products, including compliance with all laws, regulations and safety requirements or standards, regardless of any support or applications information provided by ON Semiconductor. "Typical" parameters which may be provided in ON Semiconductor data sheets and/or specifications can and do vary in different applications and actual performance may vary over time. All operating parameters, including "Typicals" must be validated for each customer application by customer's technical experts. ON Semiconductor does not convey any license under its patent rights nor the rights of others. ON Semiconductor products are not designed, intended, or authorized for use as a critical component in life support systems or any FDA Class 3 medical devices or medical devices with a same or similar classification in a foreign jurisdiction or any devices intended for implantation in the human body. Should Buyer purchase or use ON Semiconductor products for any such unintended or unauthorized application, Buyer shall indemnify and hold ON Semiconductor and its officers, employees, subsidiaries, affiliates, and distributors harmless against all claims, costs, damages, and expenses, and reasonable attorney fees arising out of, directly or indirectly, any claim of personal injury or death associated with such unintended or unauthorized use, even if such claim alleges that ON Semiconductor was negligent regarding the design or manufacture of the part. ON Semiconductor is an Equal Opportunity/Affirmative Action Employer. This literature is subject to all applicable copyright laws and is not for resale in any manner.

PUBLICATION ORDERING INFORMATION

LITERATURE FULFILLMENT:

Literature Distribution Center for ON Semiconductor
19521 E. 32nd Pkwy, Aurora, Colorado 80011 USA
Phone: 303-675-2175 or 800-344-3860 Toll Free USA/Canada
Fax: 303-675-2176 or 800-344-3867 Toll Free USA/Canada
Email: orderlit@onsemi.com

N. American Technical Support: 800-282-9855 Toll Free
USA/Canada
Europe, Middle East and Africa Technical Support:
Phone: 421 33 790 2910
Japan Customer Focus Center
Phone: 81-3-5817-1050

ON Semiconductor Website: www.onsemi.com
Order Literature: <http://www.onsemi.com/orderlit>
For additional information, please contact your local
Sales Representative