



Is Now Part of



**ON Semiconductor®**

To learn more about ON Semiconductor, please visit our website at  
[www.onsemi.com](http://www.onsemi.com)

ON Semiconductor and the ON Semiconductor logo are trademarks of Semiconductor Components Industries, LLC dba ON Semiconductor or its subsidiaries in the United States and/or other countries. ON Semiconductor owns the rights to a number of patents, trademarks, copyrights, trade secrets, and other intellectual property. A listing of ON Semiconductor's product/patent coverage may be accessed at [www.onsemi.com/site/pdf/Patent-Marking.pdf](http://www.onsemi.com/site/pdf/Patent-Marking.pdf). ON Semiconductor reserves the right to make changes without further notice to any products herein. ON Semiconductor makes no warranty, representation or guarantee regarding the suitability of its products for any particular purpose, nor does ON Semiconductor assume any liability arising out of the application or use of any product or circuit, and specifically disclaims any and all liability, including without limitation special, consequential or incidental damages. Buyer is responsible for its products and applications using ON Semiconductor products, including compliance with all laws, regulations and safety requirements or standards, regardless of any support or applications information provided by ON Semiconductor. "Typical" parameters which may be provided in ON Semiconductor data sheets and/or specifications can and do vary in different applications and actual performance may vary over time. All operating parameters, including "Typicals" must be validated for each customer application by customer's technical experts. ON Semiconductor does not convey any license under its patent rights nor the rights of others. ON Semiconductor products are not designed, intended, or authorized for use as a critical component in life support systems or any FDA Class 3 medical devices or medical devices with a same or similar classification in a foreign jurisdiction or any devices intended for implantation in the human body. Should Buyer purchase or use ON Semiconductor products for any such unintended or unauthorized application, Buyer shall indemnify and hold ON Semiconductor and its officers, employees, subsidiaries, affiliates, and distributors harmless against all claims, costs, damages, and expenses, and reasonable attorney fees arising out of, directly or indirectly, any claim of personal injury or death associated with such unintended or unauthorized use, even if such claim alleges that ON Semiconductor was negligent regarding the design or manufacture of the part. ON Semiconductor is an Equal Opportunity/Affirmative Action Employer. This literature is subject to all applicable copyright laws and is not for resale in any manner.



April 2014

# MB1S - MB8S 0.5 A Bridge Rectifiers

## Features

- Low-Leakage
- Surge Overload Rating: 35 A peak
- Ideal for Printed Circuit Board
- UL Certified: UL #E258596

## Description

The MB family of bridge rectifiers is a 0.5 A rectifier family that achieves high surge current absorption within a very small foot print. Within its small 35 mm<sup>2</sup> form factor, the MB family shines in its surge capability. In order to absorb high surge currents, the design supports a 35 A I<sub>FSM</sub> rating and a 5.0 A<sup>2</sup>Sec I<sup>2</sup>T rating. Devices in the family are also rated to breakdown voltages of up to 1000 V. These features make the MB family ideal for small power supplies that need a little extra surge capability.

For higher I<sub>FAV</sub> current ratings, lower profile packaging, or lower V<sub>F</sub> values, explore the Fairchild MDB family of bridge rectifiers. For improved V<sub>F</sub> and efficiency values in the MB package or even higher surge capability, ask about Fairchild's pending MBxSV family.

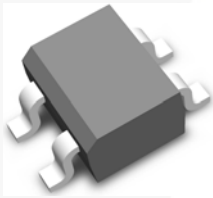

**SOIC-4**  
Polarity symbols molded  
or mark on body

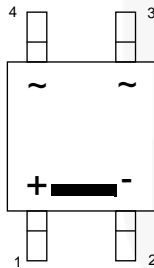

## Ordering Informations

Part Number	Marking	Package	Packing Method
MB1S	MB1S	SOIC-4	Tape and Reel
MB2S	MB2S		
MB4S	MB4S		
MB6S	MB6S		
MB8S	MB8S		

## Absolute Maximum Ratings

Stresses exceeding the absolute maximum ratings may damage the device. The device may not function or be operable above the recommended operating conditions and stressing the parts to these levels is not recommended. In addition, extended exposure to stresses above the recommended operating conditions may affect device reliability. The absolute maximum ratings are stress ratings only. Values are at  $T_A = 25^\circ\text{C}$  unless otherwise noted.

Symbol	Parameter	Value					Unit
		MB1S	MB2S	MB4S	MB6S	MB8S	
$V_{RRM}$	Maximum Repetitive Reverse Voltage	100	200	400	600	800	V
$V_{RMS}$	Maximum RMS Bridge Input Voltage	70	140	280	420	560	V
$V_R$	DC Reverse Voltage (Rated $V_R$ )	100	200	400	600	800	V
$I_{F(AV)}$	Average Rectified Forward Current at $T_A = 50^\circ\text{C}$	0.5					A
$I_{FSM}$	Non-Repetitive Peak Forward Surge Current: 8.3 ms Single Half-Sine-Wave	35					A
$T_{STG}$	Storage Temperature Range	-55 to +150					$^\circ\text{C}$
$T_J$	Operating Junction Temperature Range	-55 to +150					$^\circ\text{C}$

## Thermal Characteristics

Symbol	Parameter	Value	Unit
$P_D$	Power Dissipation	1.4	W
$R_{\theta JA}$	Thermal Resistance, Junction to Ambient, per Leg <sup>(1)</sup>	85	$^\circ\text{C}/\text{W}$
$R_{\theta JL}$	Thermal Resistance, Junction to Lead, per Leg <sup>(1)</sup>	20	$^\circ\text{C}/\text{W}$

**Note:**

1. Device mounted on PCB with 0.5 x 0.5 inch (13 x 13 mm) lead length.

## Electrical Characteristics

Values are at  $T_A = 25^\circ\text{C}$  unless otherwise specified.

Symbol	Parameter	Conditions	Value	Unit
$V_F$	Forward Voltage, per Bridge	$I_F = 0.5 \text{ A}$	1.0	V
$I_R$	Reverse Current, per Leg at Rated $V_R$	$T_A = 25^\circ\text{C}$	5.0	$\mu\text{A}$
		$T_A = 125^\circ\text{C}$	0.5	mA
$I^2t$	$I^2t$ Rating for Fusing	$t < 8.3 \text{ ms}$	5.0	$\text{A}^2\text{s}$
$C_T$	Total Capacitance, per Leg	$V_R = 4.0 \text{ V}$ , $f = 1.0 \text{ MHz}$	13	pF

### Typical Performance Characteristics

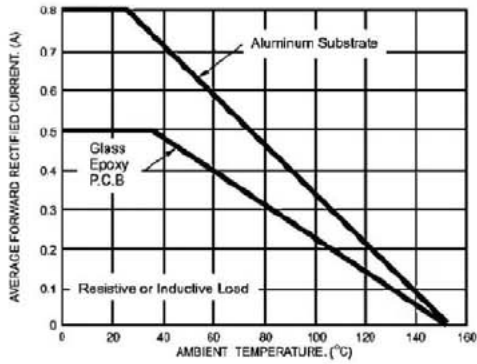

Figure 1. Derating Curve for Output Rectified Current

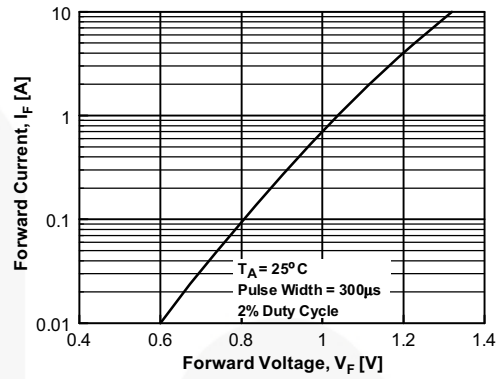

Figure 2. Forward Voltage Characteristics

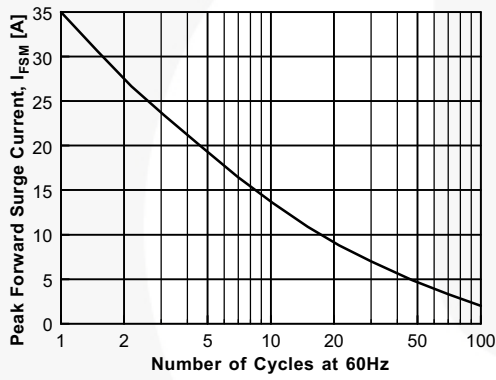

Figure 3. Non-Repetitive Surge Current

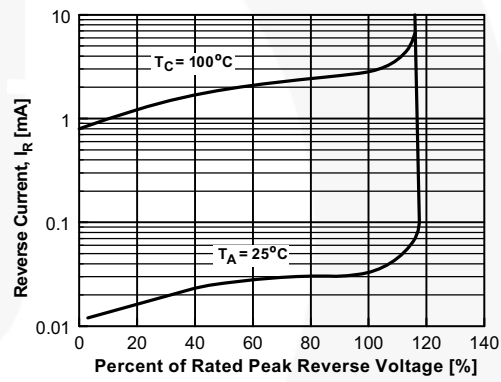
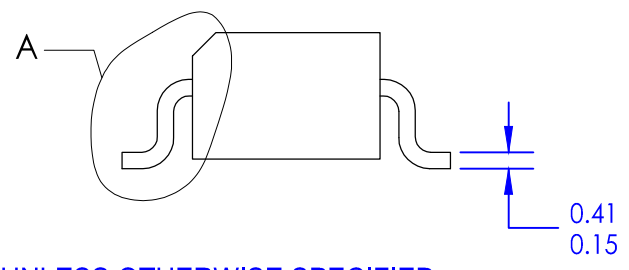
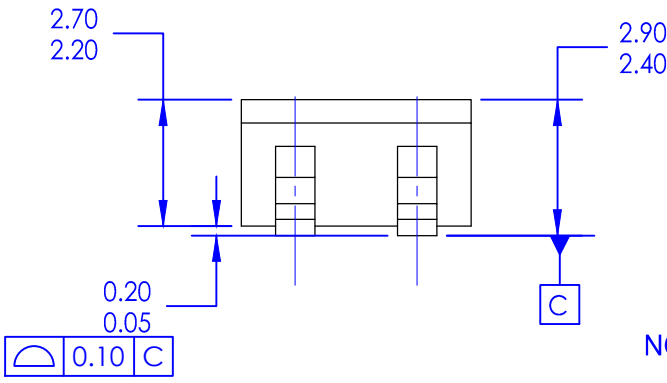
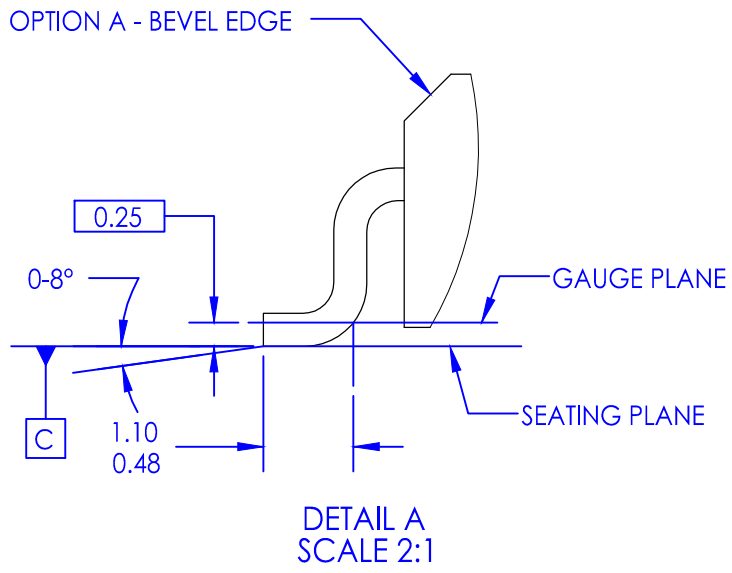

Figure 4. Reverse Current vs. Reverse Voltage



NOTES: UNLESS OTHERWISE SPECIFIED

- A. THIS PACKAGE DOES NOT CONFORM TO JEDEC TO269AA
- B. ALL DIMENSIONS ARE IN MILLIMETERS.
- C. DIMENSIONS ARE EXCLUSIVE OF BURRS, MOLD FLASH AND TIE BAR EXTRUSIONS.
- D. DIMENSIONS AND TOLERANCES AS PER ASME Y14.5-2009.
- E. LAND PATTERN AS PER IPC7351# SOIC254P960X400-4N
- F. FILE NAME: MKT-M04AREV3



ON Semiconductor and  are trademarks of Semiconductor Components Industries, LLC dba ON Semiconductor or its subsidiaries in the United States and/or other countries. ON Semiconductor owns the rights to a number of patents, trademarks, copyrights, trade secrets, and other intellectual property. A listing of ON Semiconductor's product/patent coverage may be accessed at [www.onsemi.com/site/pdf/Patent-Marking.pdf](http://www.onsemi.com/site/pdf/Patent-Marking.pdf). ON Semiconductor reserves the right to make changes without further notice to any products herein. ON Semiconductor makes no warranty, representation or guarantee regarding the suitability of its products for any particular purpose, nor does ON Semiconductor assume any liability arising out of the application or use of any product or circuit, and specifically disclaims any and all liability, including without limitation special, consequential or incidental damages. Buyer is responsible for its products and applications using ON Semiconductor products, including compliance with all laws, regulations and safety requirements or standards, regardless of any support or applications information provided by ON Semiconductor. "Typical" parameters which may be provided in ON Semiconductor data sheets and/or specifications can and do vary in different applications and actual performance may vary over time. All operating parameters, including "Typicals" must be validated for each customer application by customer's technical experts. ON Semiconductor does not convey any license under its patent rights nor the rights of others. ON Semiconductor products are not designed, intended, or authorized for use as a critical component in life support systems or any FDA Class 3 medical devices or medical devices with a same or similar classification in a foreign jurisdiction or any devices intended for implantation in the human body. Should Buyer purchase or use ON Semiconductor products for any such unintended or unauthorized application, Buyer shall indemnify and hold ON Semiconductor and its officers, employees, subsidiaries, affiliates, and distributors harmless against all claims, costs, damages, and expenses, and reasonable attorney fees arising out of, directly or indirectly, any claim of personal injury or death associated with such unintended or unauthorized use, even if such claim alleges that ON Semiconductor was negligent regarding the design or manufacture of the part. ON Semiconductor is an Equal Opportunity/Affirmative Action Employer. This literature is subject to all applicable copyright laws and is not for resale in any manner.

## PUBLICATION ORDERING INFORMATION

### LITERATURE FULFILLMENT:

Literature Distribution Center for ON Semiconductor  
19521 E. 32nd Pkwy, Aurora, Colorado 80011 USA  
**Phone:** 303-675-2175 or 800-344-3860 Toll Free USA/Canada  
**Fax:** 303-675-2176 or 800-344-3867 Toll Free USA/Canada  
**Email:** [orderlit@onsemi.com](mailto:orderlit@onsemi.com)

**N. American Technical Support:** 800-282-9855 Toll Free  
USA/Canada  
**Europe, Middle East and Africa Technical Support:**  
Phone: 421 33 790 2910  
**Japan Customer Focus Center**  
Phone: 81-3-5817-1050

**ON Semiconductor Website:** [www.onsemi.com](http://www.onsemi.com)  
**Order Literature:** <http://www.onsemi.com/orderlit>  
For additional information, please contact your local  
Sales Representative