

Printed-circuit board connector - FK-MCP 1,5/12-ST-3,81 - 1851148

Please be informed that the data shown in this PDF Document is generated from our Online Catalog. Please find the complete data in the user's documentation. Our General Terms of Use for Downloads are valid (<http://phoenixcontact.com/download>)

Plug component, nominal current: 8 A, rated voltage (III/2): 160 V, number of positions: 12, pitch: 3.81 mm, connection method: Push-in spring connection, Color: green, Contact surface: Tin

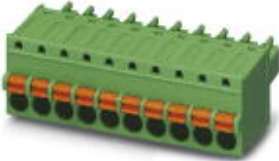

The figure shows a 10-position version of the product

Why buy this product

- ✓ Time saving push-in connection, tools not required
- ✓ Defined contact force ensures that contact remains stable over the long term
- ✓ Intuitive use through colour coded actuation lever
- ✓ Operation and conductor connection from one direction enable integration into front of device
- ✓ Quick and convenient testing using integrated test option



Key Commercial Data

Packing unit	1 STK
GTIN	 4 017918 109653
GTIN	4017918109653
Weight per Piece (excluding packing)	11.330 g
Custom tariff number	85366990
Country of origin	Germany

Technical data

Dimensions

Length	21 mm
Height	12.4 mm
Width	46.51 mm
Pitch	3.81 mm

Printed-circuit board connector - FK-MCP 1,5/12-ST-3,81 - 1851148

Technical data

Dimensions

Dimension a	41.91 mm
-------------	----------

General

Range of articles	FK-MCP 1,5/...-ST
Type of contact	Female connector
Number of positions	12
Connection method	Push-in spring connection
Insulating material group	I
Rated surge voltage (III/3)	2.5 kV
Rated surge voltage (III/2)	2.5 kV
Rated surge voltage (II/2)	2.5 kV
Rated voltage (III/3)	160 V
Rated voltage (III/2)	160 V
Rated voltage (II/2)	320 V
Connection in acc. with standard	EN-VDE
Nominal current I_N	8 A
Nominal cross section	1.5 mm ²
Maximum load current	8 A (with 1.5 mm ² conductor cross section)
Insulating material	PA
Flammability rating according to UL 94	V0
Internal cylindrical gage	A1
Stripping length	9 mm

Connection data

Conductor cross section solid min.	0.14 mm ²
Conductor cross section solid max.	1.5 mm ²
Conductor cross section flexible min.	0.14 mm ²
Conductor cross section flexible max.	1.5 mm ²
Conductor cross section flexible, with ferrule without plastic sleeve min.	0.25 mm ²
Conductor cross section flexible, with ferrule without plastic sleeve max.	1.5 mm ²
Conductor cross section flexible, with ferrule with plastic sleeve min.	0.25 mm ²
Conductor cross section flexible, with ferrule with plastic sleeve max.	0.75 mm ²
Conductor cross section AWG min.	26
Conductor cross section AWG max.	16
Minimum AWG according to UL/CUL	28
Maximum AWG according to UL/CUL	16

Standards and Regulations

Connection in acc. with standard	EN-VDE
----------------------------------	--------

Printed-circuit board connector - FK-MCP 1,5/12-ST-3,81 - 1851148

Technical data

Standards and Regulations

	CSA
Flammability rating according to UL 94	V0

Environmental Product Compliance

China RoHS	Environmentally friendly use period: unlimited = EFUP-e
	No hazardous substances above threshold values

Drawings

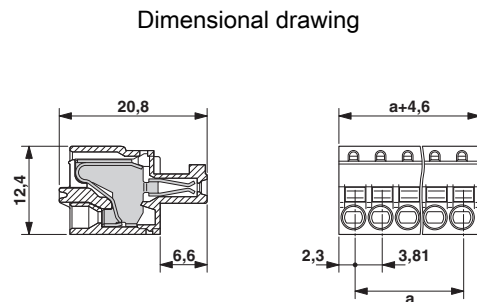
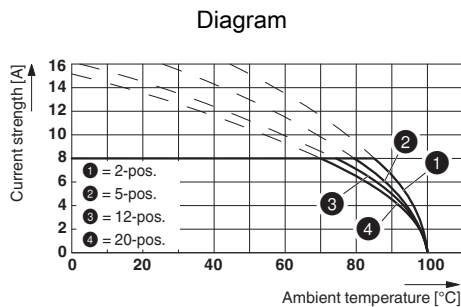

Type: FK-MCP 1,5/...-ST(F)-3,81 with MC 1,5/...-G(F)-3,81 P.. THR(R...)

Classifications

eCl@ss

eCl@ss 4.0	272607xx
eCl@ss 4.1	27260701
eCl@ss 5.0	27260701
eCl@ss 5.1	27260701
eCl@ss 6.0	27260704
eCl@ss 7.0	27440402
eCl@ss 8.0	27440309
eCl@ss 9.0	27440309

ETIM

ETIM 3.0	EC001121
ETIM 4.0	EC002638
ETIM 5.0	EC002638
ETIM 6.0	EC002638

Printed-circuit board connector - FK-MCP 1,5/12-ST-3,81 - 1851148

Classifications

UNSPSC

UNSPSC 6.01	30211810
UNSPSC 7.0901	39121409
UNSPSC 11	39121409
UNSPSC 12.01	39121409
UNSPSC 13.2	39121409

Approvals

Approvals

Approvals

CSA / VDE Gutachten mit Fertigungsüberwachung / IEC60335 CB Scheme / CCA / cULus Recognized / EAC

Ex Approvals

Approval details

CSA		http://www.csagroup.org/services/testing-and-certification/certified-product-listing/	13631
		B	
mm ² /AWG/kcmil		28-16	
Nominal current I _N		8 A	
Nominal voltage U _N		300 V	

VDE Gutachten mit Fertigungsüberwachung		http://www.vde.com/en/Institute/OnlineService/VDE-approved-products/Pages/Online-Search.aspx	40011723
		0.2-1.5	
mm ² /AWG/kcmil		0.2-1.5	
Nominal current I _N		8 A	
Nominal voltage U _N		160 V	

Printed-circuit board connector - FK-MCP 1,5/12-ST-3,81 - 1851148

Approvals

IECEE CB Scheme		http://www.iecee.org/	DE1-58415-B1B2
mm ² /AWG/kcmil		0.2-1.5	
Nominal current IN		8 A	
Nominal voltage UN		160 V	

CCA			CCA/ DE1 34219
mm ² /AWG/kcmil		0.2-1.5	
Nominal current IN		8 A	
Nominal voltage UN		160 V	

cULus Recognized		http://database.ul.com/cgi-bin/XYV/template/LISEXT/1FRAME/index.htm	E60425-19920306
		B	
mm ² /AWG/kcmil		28-16	
Nominal current IN		8 A	
Nominal voltage UN		300 V	

EAC			B.01742
-----	--	--	---------

Accessories

Accessories

Crimping tool

Crimping pliers - CRIMPFOX 6 - 1212034



Crimping pliers, for ferrules without insulating collar according to DIN 46228 Part 1 and ferrules with insulating collar according to DIN 46228 Part 4, 0.25 mm² ... 6.0 mm², lateral entry, trapezoidal crimp

Labeled terminal marker

Printed-circuit board connector - FK-MCP 1,5/12-ST-3,81 - 1851148

Accessories

Marker card - SK 3,81/2,8:FORTL.ZAHLEN - 0804109



Marker card, Card, white, labeled, Horizontal: Consecutive numbers 1 - 10, 11 - 20, etc. up to 91 - (99)100, Mounting type: Adhesive, for terminal block width: 3.81 mm, Lettering field: 3.81 x 2.8 mm

Screwdriver tools

Screwdriver - SZS 0,4X2,5 VDE - 1205037



Screwdriver, slot-headed, VDE insulated, size: 0.4 x 2.5 x 80 mm, 2-component grip, with non-slip grip

Terminal marking

Marker card - SK U/2,8 WH:UNBEDRUCKT - 0803883



Marker card, Sheet, white, unlabeled, can be labeled with: CMS-P1-PLOTTER, PLOTMARK, Office printing systems, Mounting type: Adhesive, Lettering field: 186 x 2.8 mm

Test plugs - MPS-MT 1-S - 1944372



Test plugs, consisting of \varnothing 1 mm test pin, 150 mm conductor length, and \varnothing 2 mm socket

Additional products

Printed-circuit board connector - FK-MCP 1,5/12-ST-3,81 - 1851148

Accessories

Base strip - MCV 1,5/12-G-3,81 P14 THR - 1707104

Header, nominal current: 8 A, rated voltage (III/2): 160 V, number of positions: 12, pitch: 3.81 mm, Color: black, Contact surface: Tin, mounting: THR soldering, User information and design recommendations for through hole reflow technology can be found under "Downloads"



Base strip - MCV 1,5/12-G-3,81 P26 THR - 1707528

Header, nominal current: 8 A, rated voltage (III/2): 160 V, number of positions: 12, pitch: 3.81 mm, Color: black, Contact surface: Tin, mounting: THR soldering, User information and design recommendations for through hole reflow technology can be found under "Downloads"



Base strip - MCV 1,5/12-G-3,81 P26 THRR72 - 1712982

Header, nominal current: 8 A, rated voltage (III/2): 160 V, number of positions: 12, pitch: 3.81 mm, Color: black, Contact surface: Tin, mounting: THR soldering



Printed-circuit board connector - MC 1,5/12-G-3,81 P20 THRR72 - 1782679

Header, nominal current: 8 A, rated voltage (III/2): 160 V, number of positions: 12, pitch: 3.81 mm, Color: black, Contact surface: Tin, mounting: THR soldering, User information and design recommendations for through hole reflow technology can be found under "Downloads"



Base strip - MC 1,5/12-G-3,81 - 1803374

Header, nominal current: 8 A, rated voltage (III/2): 160 V, number of positions: 12, pitch: 3.81 mm, Color: green, Contact surface: Tin, mounting: Wave soldering



Printed-circuit board connector - FK-MCP 1,5/12-ST-3,81 - 1851148

Accessories

Base strip - MCV 1,5/12-G-3,81 - 1803523



Header, nominal current: 8 A, rated voltage (III/2): 160 V, number of positions: 12, pitch: 3.81 mm, Color: green, Contact surface: Tin, mounting: Wave soldering

Base strip - SMC 1,5/12-G-3,81 - 1827376



Header, nominal current: 8 A, rated voltage (III/2): 160 V, number of positions: 12, pitch: 3.81 mm, Color: green, Contact surface: Tin, mounting: Wave soldering

Base strip - MCD 1,5/12-G-3,81 - 1830059



Header, nominal current: 8 A, rated voltage (III/2): 160 V, number of positions: 12, pitch: 3.81 mm, Color: green, Contact surface: Tin, mounting: Wave soldering, In combination with MCV plug components, both an MCVW and an MCVR plug must be used.

Base strip - MCDV 1,5/12-G-3,81 - 1830509



Header, nominal current: 8 A, rated voltage (III/2): 160 V, number of positions: 12, pitch: 3.81 mm, Color: green, Contact surface: Tin, mounting: Wave soldering, In combination with MCV plug components, both an MCVW and an MCVR plug must be used.

Base strip - MCVDU 1,5/12-G-3,81 - 1837531

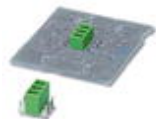

Header, nominal current: 8 A, rated voltage (III/2): 160 V, number of positions: 12, pitch: 3.81 mm, Color: green, Contact surface: Tin, mounting: Wave soldering

Printed-circuit board connector - FK-MCP 1,5/12-ST-3,81 - 1851148

Accessories

Base strip - MCD 1,5/12-G1-3,81 - 1843172

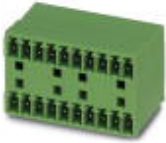

Header, nominal current: 8 A, rated voltage (III/2): 160 V, number of positions: 12, pitch: 3.81 mm, Color: green, Contact surface: Tin, mounting: Wave soldering, In combination with MCV plug components, both an MCVW and an MCVR plug must be used.

Base strip - MCDV 1,5/12-G1-3,81 - 1847835



Header, nominal current: 8 A, rated voltage (III/2): 160 V, number of positions: 12, pitch: 3.81 mm, Color: green, Contact surface: Tin, mounting: Wave soldering, In combination with MCV plug components, both an MCVW and an MCVR plug must be used.

Base strip - EMCV 1,5/12-G-3,81 - 1860744



Header, nominal current: 8 A, rated voltage (III/2): 160 V, number of positions: 12, pitch: 3.81 mm, Color: green, Contact surface: Tin, mounting: Press-in technology

Base strip - EMC 1,5/12-G-3,81 - 1897908



Header, nominal current: 8 A, rated voltage (III/2): 160 V, number of positions: 12, pitch: 3.81 mm, Color: green, Contact surface: Tin, mounting: Press-in technology

Base strip - MC 1,5/12-G-3,81 THT - 1908868



Header, nominal current: 8 A, rated voltage (III/2): 160 V, number of positions: 12, pitch: 3.81 mm, Color: black, Contact surface: Tin, mounting: THR soldering, User information and design recommendations for through hole reflow technology can be found under "Downloads"

