



Is Now Part of



**ON Semiconductor®**

To learn more about ON Semiconductor, please visit our website at  
[www.onsemi.com](http://www.onsemi.com)

ON Semiconductor and the ON Semiconductor logo are trademarks of Semiconductor Components Industries, LLC dba ON Semiconductor or its subsidiaries in the United States and/or other countries. ON Semiconductor owns the rights to a number of patents, trademarks, copyrights, trade secrets, and other intellectual property. A listing of ON Semiconductor's product/patent coverage may be accessed at [www.onsemi.com/site/pdf/Patent-Marking.pdf](http://www.onsemi.com/site/pdf/Patent-Marking.pdf). ON Semiconductor reserves the right to make changes without further notice to any products herein. ON Semiconductor makes no warranty, representation or guarantee regarding the suitability of its products for any particular purpose, nor does ON Semiconductor assume any liability arising out of the application or use of any product or circuit, and specifically disclaims any and all liability, including without limitation special, consequential or incidental damages. Buyer is responsible for its products and applications using ON Semiconductor products, including compliance with all laws, regulations and safety requirements or standards, regardless of any support or applications information provided by ON Semiconductor. "Typical" parameters which may be provided in ON Semiconductor data sheets and/or specifications can and do vary in different applications and actual performance may vary over time. All operating parameters, including "Typicals" must be validated for each customer application by customer's technical experts. ON Semiconductor does not convey any license under its patent rights nor the rights of others. ON Semiconductor products are not designed, intended, or authorized for use as a critical component in life support systems or any FDA Class 3 medical devices or medical devices with a same or similar classification in a foreign jurisdiction or any devices intended for implantation in the human body. Should Buyer purchase or use ON Semiconductor products for any such unintended or unauthorized application, Buyer shall indemnify and hold ON Semiconductor and its officers, employees, subsidiaries, affiliates, and distributors harmless against all claims, costs, damages, and expenses, and reasonable attorney fees arising out of, directly or indirectly, any claim of personal injury or death associated with such unintended or unauthorized use, even if such claim alleges that ON Semiconductor was negligent regarding the design or manufacture of the part. ON Semiconductor is an Equal Opportunity/Affirmative Action Employer. This literature is subject to all applicable copyright laws and is not for resale in any manner.



# FGL40N120AND

## 1200V NPT IGBT

### Features

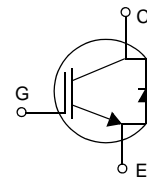
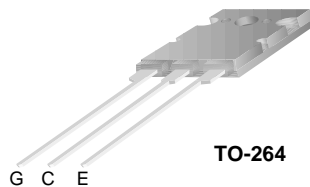
- High speed switching
- Low saturation voltage :  $V_{CE(sat)} = 2.6\text{ V @ } I_C = 40\text{ A}$
- High input impedance
- CO-PAK, IGBT with FRD :  $t_{rr} = 75\text{ ns (typ.)}$

### Description

Employing NPT technology, Fairchild's AND series of IGBTs provides low conduction and switching losses. The AND series offers an solution for application such as induction heating (IH), motor control, general purpose inverters and uninterruptible power supplies (UPS).

### Applications

Induction Heating, UPS, AC & DC motor controls and general purpose inverters.



### Absolute Maximum Ratings

Symbol	Parameter	FGL40N120AND	Units
$V_{CES}$	Collector-Emitter Voltage	1200	V
$V_{GES}$	Gate-Emitter Voltage	$\pm 25$	V
$I_C$	Collector Current @ $T_C = 25^\circ\text{C}$	64	A
	Collector Current @ $T_C = 100^\circ\text{C}$	40	A
$I_{CM(1)}$	Pulsed Collector Current	160	A
$I_F$	Diode Continuous Forward Current @ $T_C = 100^\circ\text{C}$	40	A
$I_{FM}$	Diode Maximum Forward Current	240	A
$P_D$	Maximum Power Dissipation @ $T_C = 25^\circ\text{C}$	500	W
	Maximum Power Dissipation @ $T_C = 100^\circ\text{C}$	200	W
SCWT	Short Circuit Withstand Time, $V_{CE} = 600\text{V}, V_{GE} = 15\text{V}, T_C = 125^\circ\text{C}$	10	$\mu\text{s}$
$T_J$	Operating Junction Temperature	-55 to +150	$^\circ\text{C}$
$T_{STG}$	Storage Temperature Range	-55 to +150	$^\circ\text{C}$
$T_L$	Maximum Lead Temp. for Soldering Purposes, 1/8" from Case for 5 seconds	300	$^\circ\text{C}$

**Notes:**

(1) Pulse width limited by max. junction temperature

### Thermal Characteristics

Symbol	Parameter	Typ.	Max.	Units
$R_{\theta JC}(\text{IGBT})$	Thermal Resistance, Junction-to-Case	--	0.25	$^\circ\text{C/W}$
$R_{\theta JC}(\text{DIODE})$	Thermal Resistance, Junction-to-Case	--	0.7	$^\circ\text{C/W}$
$R_{\theta JA}$	Thermal Resistance, Junction-to-Ambient	--	25	$^\circ\text{C/W}$

## Package Marking and Ordering Information

Device Marking	Device	Package	Reel Size	Tape Width	Quantity
FGL40N120AND	FGL40N120AND	TO-264	-	-	25

## Electrical Characteristics of the IGBT T<sub>C</sub> = 25°C unless otherwise noted

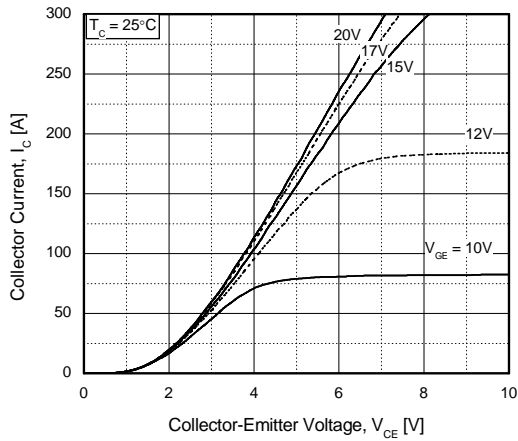
Symbol	Parameter	Conditions	Min.	Typ.	Max.	Units
<b>Off Characteristics</b>						
BV <sub>CES</sub>	Collector-Emitter Breakdown Voltage	V <sub>GE</sub> = 0V, I <sub>C</sub> = 1mA	1200	--	--	V
BV <sub>CES</sub> /ΔT <sub>J</sub>	Temperature Coefficient of Breakdown Voltage	V <sub>GE</sub> = 0V, I <sub>C</sub> = 1mA	--	0.6	--	V/°C
I <sub>CES</sub>	Collector Cut-Off Current	V <sub>CE</sub> = V <sub>CES</sub> , V <sub>GE</sub> = 0V	--	--	1	mA
I <sub>GES</sub>	G-E Leakage Current	V <sub>GE</sub> = V <sub>GES</sub> , V <sub>CE</sub> = 0V	--	--	±250	nA
<b>On Characteristics</b>						
V <sub>GE(th)</sub>	G-E Threshold Voltage	I <sub>C</sub> = 250μA, V <sub>CE</sub> = V <sub>GE</sub>	3.5	5.5	7.5	V
V <sub>CE(sat)</sub>	Collector to Emitter Saturation Voltage	I <sub>C</sub> = 40A, V <sub>GE</sub> = 15V	--	2.6	3.2	V
		I <sub>C</sub> = 40A, V <sub>GE</sub> = 15V, T <sub>C</sub> = 125°C	--	2.9	--	V
		I <sub>C</sub> = 64A, V <sub>GE</sub> = 15V	--	3.15	--	V
<b>Dynamic Characteristics</b>						
C <sub>ies</sub>	Input Capacitance	V <sub>CE</sub> = 30V, V <sub>GE</sub> = 0V f = 1MHz	--	3200	--	pF
C <sub>oes</sub>	Output Capacitance		--	370	--	pF
C <sub>res</sub>	Reverse Transfer Capacitance		--	125	--	pF
<b>Switching Characteristics</b>						
t <sub>d(on)</sub>	Turn-On Delay Time	V <sub>CC</sub> = 600V, I <sub>C</sub> = 40A, R <sub>G</sub> = 5Ω, V <sub>GE</sub> = 15V, Inductive Load, T <sub>C</sub> = 25°C	--	15	--	ns
t <sub>r</sub>	Rise Time		--	20	--	ns
t <sub>d(off)</sub>	Turn-Off Delay Time		--	110	--	ns
t <sub>f</sub>	Fall Time		--	40	80	ns
E <sub>on</sub>	Turn-On Switching Loss		--	2.3	3.45	mJ
E <sub>off</sub>	Turn-Off Switching Loss		--	1.1	1.65	mJ
E <sub>ts</sub>	Total Switching Loss		--	3.4	5.1	mJ
t <sub>d(on)</sub>	Turn-On Delay Time	V <sub>CC</sub> = 600V, I <sub>C</sub> = 40A, R <sub>G</sub> = 5Ω, V <sub>GE</sub> = 15V, Inductive Load, T <sub>C</sub> = 125°C	--	20	--	ns
t <sub>r</sub>	Rise Time		--	25	--	ns
t <sub>d(off)</sub>	Turn-Off Delay Time		--	120	--	ns
t <sub>f</sub>	Fall Time		--	45	--	ns
E <sub>on</sub>	Turn-On Switching Loss		--	2.5	--	mJ
E <sub>off</sub>	Turn-Off Switching Loss		--	1.8	--	mJ
E <sub>ts</sub>	Total Switching Loss		--	4.3	--	mJ
Q <sub>g</sub>	Total Gate charge	V <sub>CE</sub> = 600V, I <sub>C</sub> = 40A, V <sub>GE</sub> = 15V	--	220	330	nC
Q <sub>ge</sub>	Gate-Emitter Charge		--	25	38	nC
Q <sub>gc</sub>	Gate-Collector Charge		--	130	195	nC

**Electrical Characteristics of DIODE**  $T_C = 25^\circ\text{C}$  unless otherwise noted

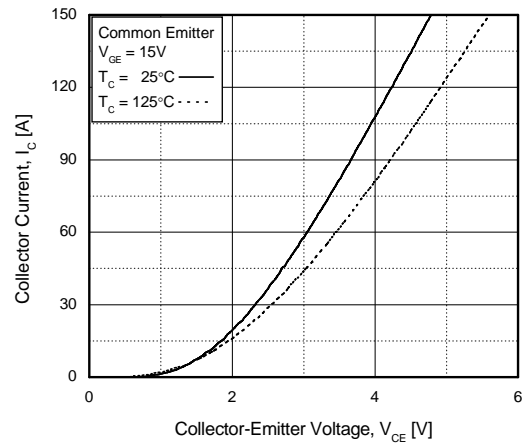
Symbol	Parameter	Test Conditions	Min.	Typ.	Max.	Units	
$V_{FM}$	Diode Forward Voltage	$I_F = 40\text{A}$	$T_C = 25^\circ\text{C}$	--	3.2	4.0	V
			$T_C = 125^\circ\text{C}$	--	2.7	--	
$t_{rr}$	Diode Reverse Recovery Time	$I_F = 40\text{A},$ $di/dt = 200\text{A}/\mu\text{s}$	$T_C = 25^\circ\text{C}$	--	75	112	nS
			$T_C = 125^\circ\text{C}$	--	130	--	
$I_{rr}$	Diode Peak Reverse Recovery Current	$I_F = 40\text{A},$ $di/dt = 200\text{A}/\mu\text{s}$	$T_C = 25^\circ\text{C}$	--	8	12	A
			$T_C = 125^\circ\text{C}$	--	13	--	
$Q_{rr}$	Diode Reverse Recovery Charge	$I_F = 40\text{A},$ $di/dt = 200\text{A}/\mu\text{s}$	$T_C = 25^\circ\text{C}$	--	300	450	nC
			$T_C = 125^\circ\text{C}$	--	845	--	

## Typical Performance Characteristics

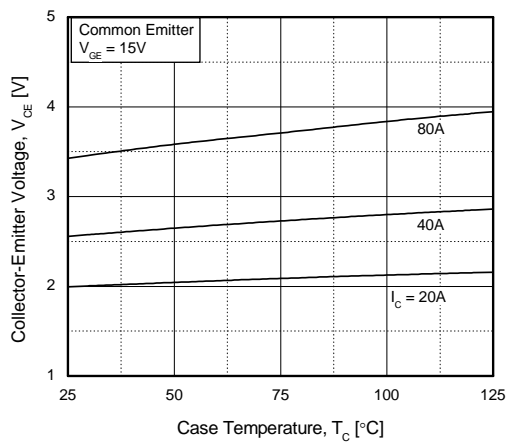
**Figure 1. Typical Output Characteristics**



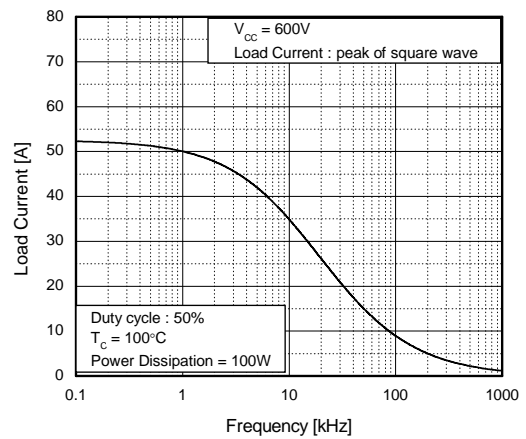
**Figure 2. Typical Saturation Voltage Characteristics**



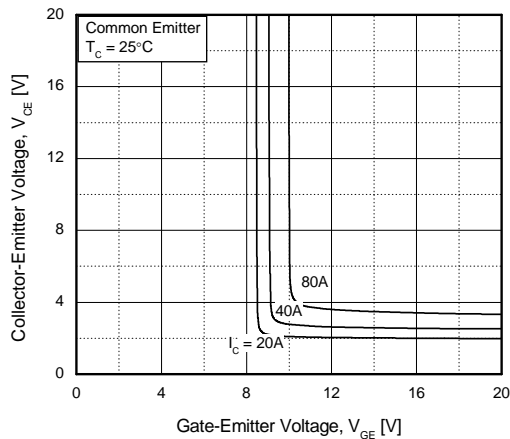
**Figure 3. Saturation Voltage vs. Case Temperature at Variant Current Level**



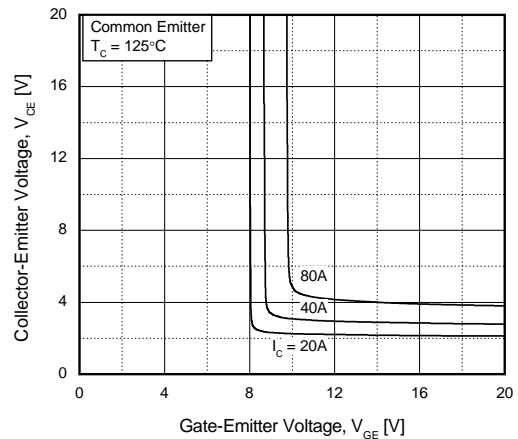
**Figure 4. Load Current vs. Frequency**



**Figure 5. Saturation Voltage vs. V\_GE**

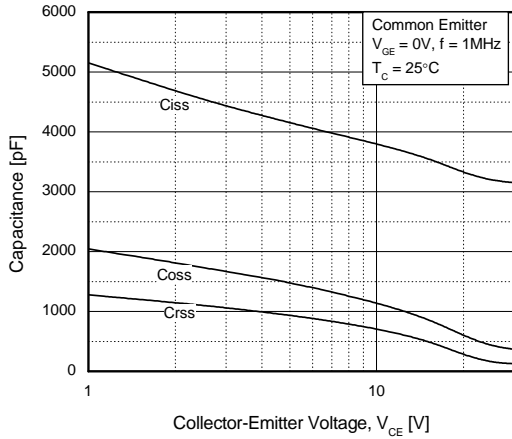


**Figure 6. Saturation Voltage vs. V\_GE**

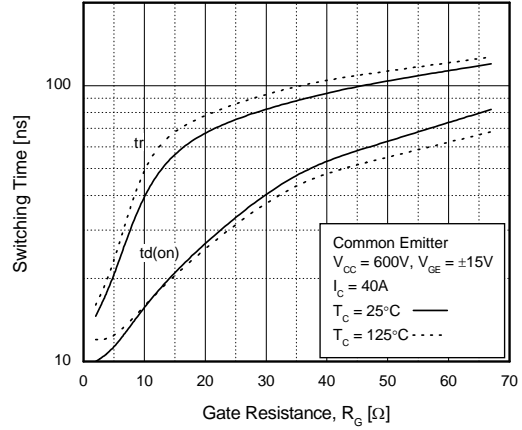


**Typical Performance Characteristics (Continued)**

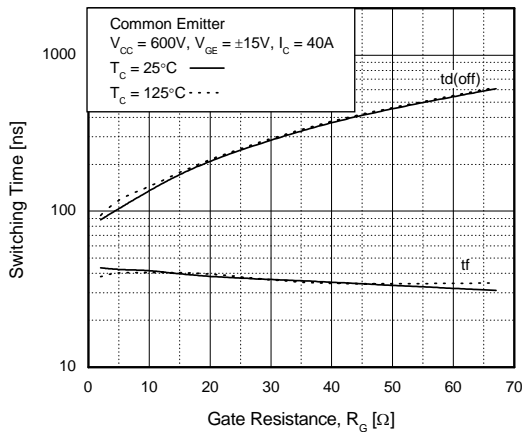
**Figure 7. Capacitance Characteristics**



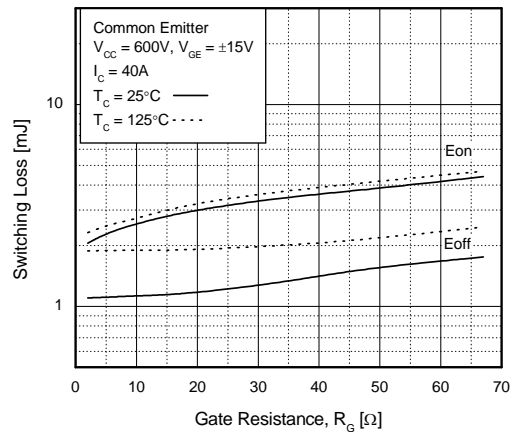
**Figure 8. Turn-On Characteristics vs. Gate Resistance**



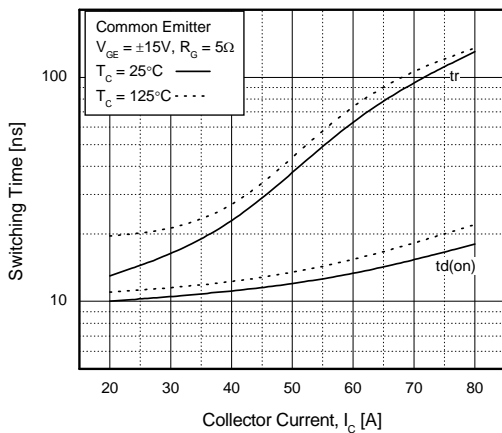
**Figure 9. Turn-Off Characteristics vs. Gate Resistance**



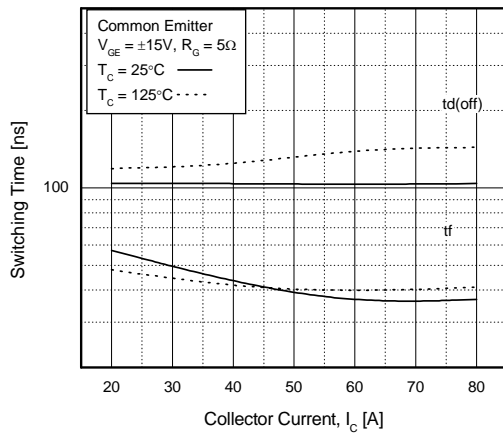
**Figure 10. Switching Loss vs. Gate Resistance**



**Figure 11. Turn-On Characteristics vs. Collector Current**

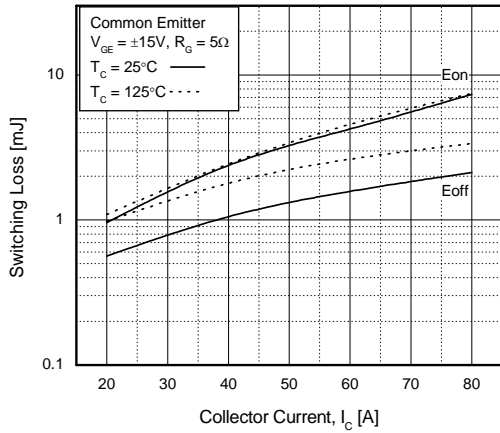


**Figure 12. Turn-Off Characteristics vs. Collector Current**

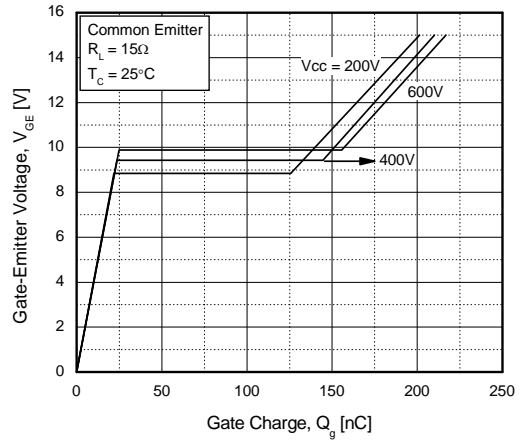


**Typical Performance Characteristics (Continued)**

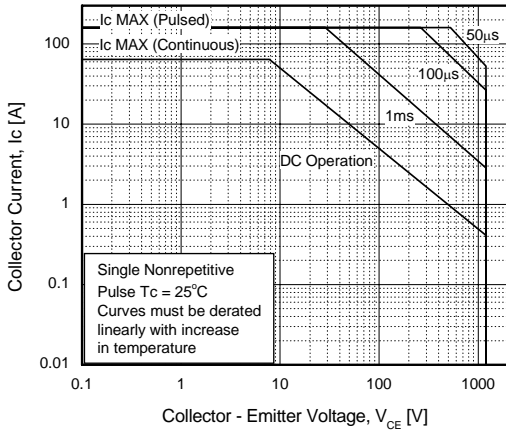
**Figure 13. Switching Loss vs. Collector Current**



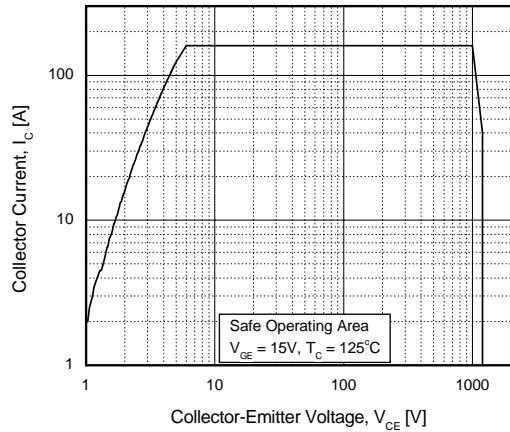
**Figure 14. Gate Charge Characteristics**



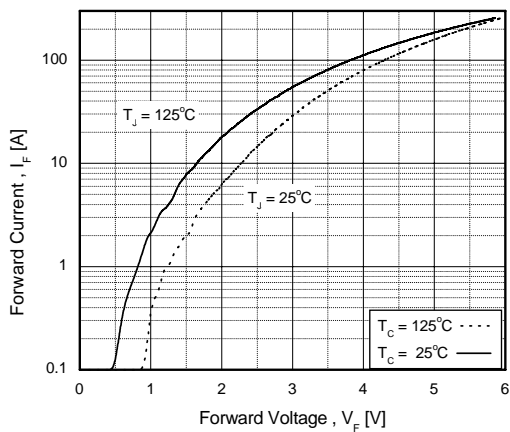
**Figure 15. SOA Characteristics**



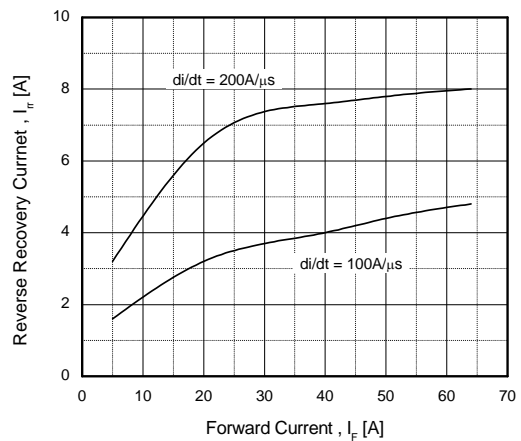
**Figure 16. Turn-Off SOA**



**Figure 17. Forward Characteristics**

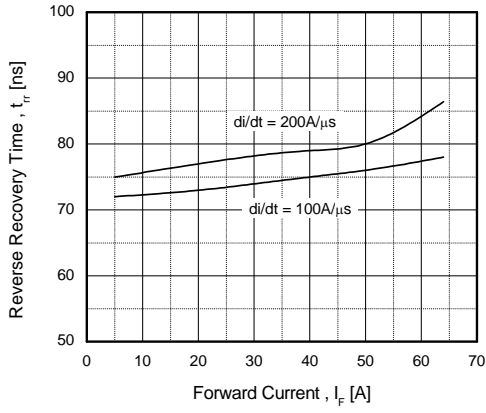


**Figure 18. Reverse Recovery Current**

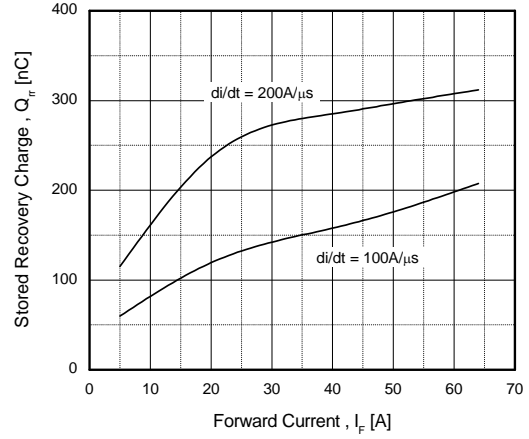


**Typical Performance Characteristics (Continued)**

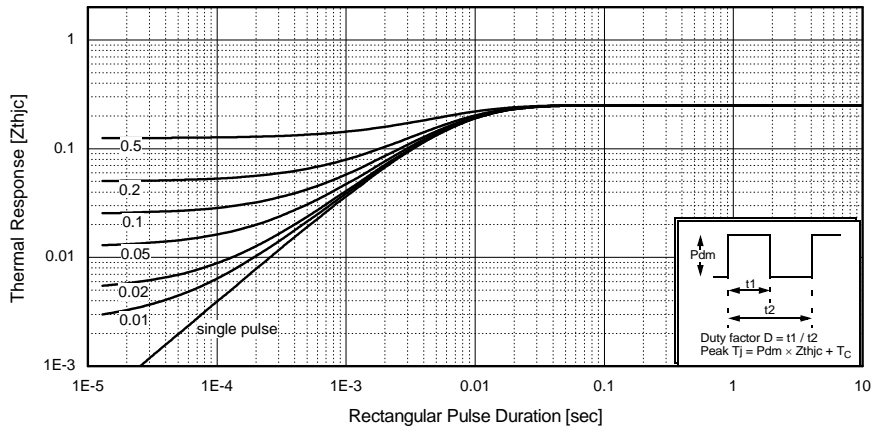
**Figure 19. Stored Charge**



**Figure 20. Reverse Recovery Time**



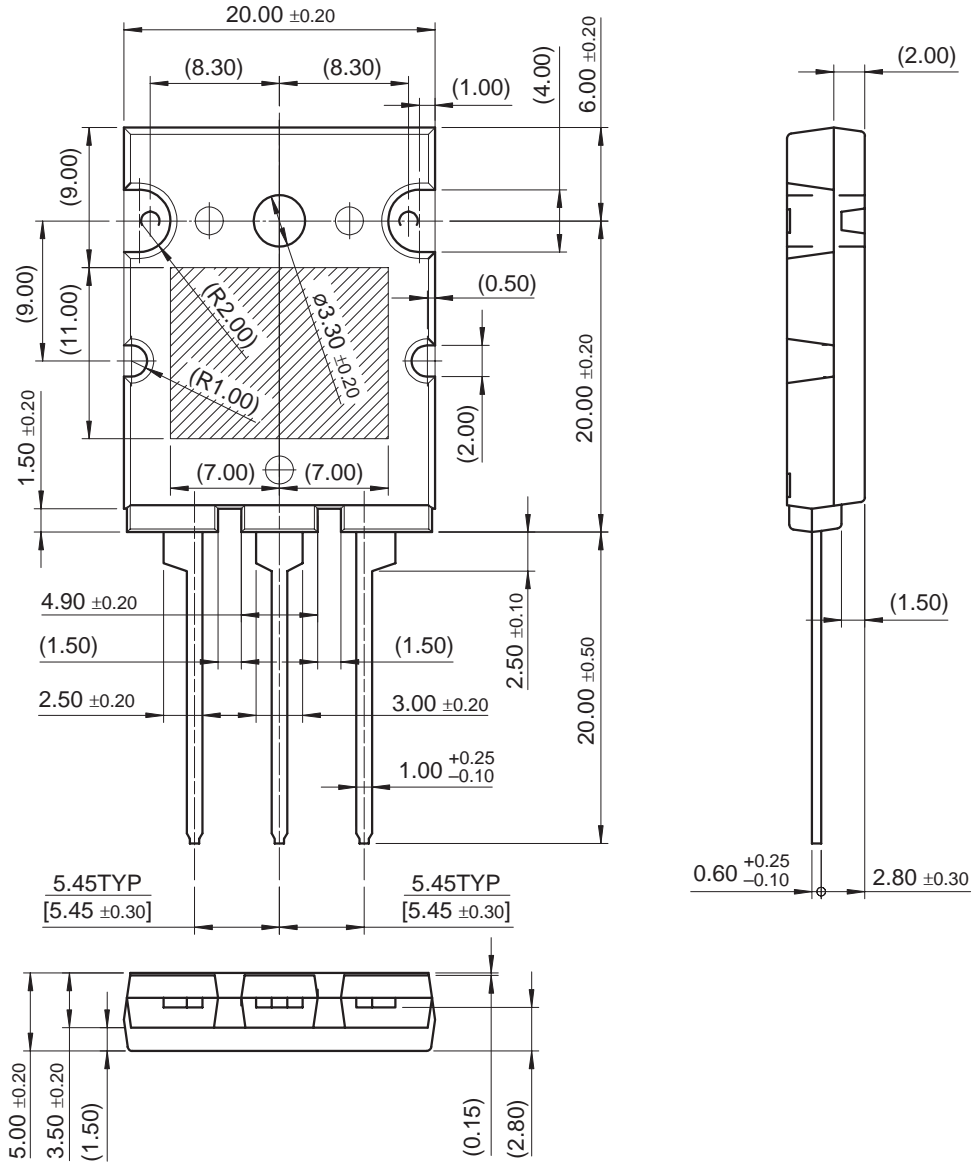
**Figure 21. Transient Thermal Impedance of IGBT**





Mechanical Dimensions

TO-264







Dimensions in Millimeters



**TRADEMARKS**

The following includes registered and unregistered trademarks and service marks, owned by Fairchild Semiconductor and/or its global subsidiaries, and is not intended to be an exhaustive list of all such trademarks.

- |   |  |  |   |
|---|--|--|---|
| ACEx <sup>®</sup>   | FPST <sup>™</sup>  | PDP-SPM <sup>™</sup>                   | SupreMOS <sup>™</sup>   |
| Build it Now <sup>™</sup>   | FRFET <sup>®</sup>   | Power220 <sup>®</sup>                  | SyncFET <sup>™</sup>  |
| CorePLUS <sup>™</sup>   | Global Power Resource <sup>SM</sup>  | POWEREDGE <sup>®</sup>                 |  SYSTEM <sup>®</sup> |
| CROSSVOLT <sup>™</sup>  | Green FPS <sup>™</sup>   | Power-SPM <sup>™</sup>                 | The Power Franchise <sup>®</sup>  |
| CTL <sup>™</sup>  | Green FPS <sup>™</sup> e-Series <sup>™</sup>   | PowerTrench <sup>®</sup>               | the <b>power</b> franchise  |
| Current Transfer Logic <sup>™</sup>   | GTO <sup>™</sup>   | Programmable Active Droop <sup>™</sup> | TinyBoost <sup>™</sup>  |
| EcoSPARK <sup>®</sup>   | <i>i-Lo</i> <sup>™</sup>   | QFET <sup>®</sup>                      | TinyBuck <sup>™</sup>   |
| EZSWITCH <sup>™</sup> *   | IntelliMAX <sup>™</sup>  | QS <sup>™</sup>                        | TinyLogic <sup>®</sup>  |
|  EZ <sup>™</sup> | ISOPLANAR <sup>™</sup>   | QT Optoelectronics <sup>™</sup>        | TINYOPTO <sup>™</sup>   |
|  F <sup>®</sup>  | MegaBuck <sup>™</sup>  | Quiet Series <sup>™</sup>              | TinyPower <sup>™</sup>  |
| Fairchild <sup>®</sup>  | MICROCOUPLER <sup>™</sup>  | RapidConfigure <sup>™</sup>            | TinyPWM <sup>™</sup>  |
| Fairchild Semiconductor <sup>®</sup>  | MicroFET <sup>™</sup>  | SMART START <sup>™</sup>               | TinyWire <sup>™</sup>   |
| FACT Quiet Series <sup>™</sup>  | MicroPak <sup>™</sup>  | SPM <sup>®</sup>                       | µSerDes <sup>™</sup>  |
| FACT <sup>®</sup>   | MillerDrive <sup>™</sup>   | STEALTH <sup>™</sup>                   | UHC <sup>®</sup>  |
| FAST <sup>®</sup>   | Motion-SPM <sup>™</sup>  | SuperFET <sup>™</sup>                  | Ultra FRFET <sup>™</sup>  |
| FastvCore <sup>™</sup>  | OPTOLOGIC <sup>®</sup>   | SuperSOT <sup>™</sup> -3               | UniFET <sup>™</sup>   |
| FlashWriter <sup>®</sup> *  | OPTOPLANAR <sup>®</sup>  | SuperSOT <sup>™</sup> -6               | VCX <sup>™</sup>  |
|   |  <sup>®</sup> | SuperSOT <sup>™</sup> -8               |   |

\* EZSWITCH<sup>™</sup> and FlashWriter<sup>®</sup> are trademarks of System General Corporation, used under license by Fairchild Semiconductor.

**DISCLAIMER**

FAIRCHILD SEMICONDUCTOR RESERVES THE RIGHT TO MAKE CHANGES WITHOUT NOTICE TO ANY PRODUCTS HEREIN TO IMPROVE RELIABILITY, FUNCTION, OR DESIGN. FAIRCHILD DOES NOT ASSUME ANY LIABILITY ARISING OUT OF THE APPLICATION OR USE OF ANY PRODUCT OR CIRCUIT DESCRIBED HEREIN; NEITHER DOES IT CONVEY ANY LICENSE UNDER ITS PATENT RIGHTS, NOR THE RIGHTS OF OTHERS. THESE SPECIFICATIONS DO NOT EXPAND THE TERMS OF FAIRCHILD'S WORLDWIDE TERMS AND CONDITIONS, SPECIFICALLY THE WARRANTY THEREIN, WHICH COVERS THESE PRODUCTS.

**LIFE SUPPORT POLICY**

FAIRCHILD'S PRODUCTS ARE NOT AUTHORIZED FOR USE AS CRITICAL COMPONENTS IN LIFE SUPPORT DEVICES OR SYSTEMS WITHOUT THE EXPRESS WRITTEN APPROVAL OF FAIRCHILD SEMICONDUCTOR CORPORATION.

As used herein:

- Life support devices or systems are devices or systems which, (a) are intended for surgical implant into the body or (b) support or sustain life, and (c) whose failure to perform when properly used in accordance with instructions for use provided in the labeling, can be reasonably expected to result in a significant injury to the user.
- A critical component in any component of a life support, device or system whose failure to perform can be reasonably expected to cause the failure of the life support device or system, or to affect its safety or effectiveness.

**PRODUCT STATUS DEFINITIONS**

**Definition of Terms**

Datasheet Identification	Product Status	Definition
Advance Information	Formative or In Design	This datasheet contains the design specifications for product development. Specifications may change in any manner without notice.
Preliminary	First Production	This datasheet contains preliminary data; supplementary data will be published at a later date. Fairchild Semiconductor reserves the right to make changes at any time without notice to improve design.
No Identification Needed	Full Production	This datasheet contains final specifications. Fairchild Semiconductor reserves the right to make changes at any time without notice to improve design.
Obsolete	Not In Production	This datasheet contains specifications on a product that has been discontinued by Fairchild Semiconductor. The datasheet is printed for reference information only.

Rev. I33

ON Semiconductor and  are trademarks of Semiconductor Components Industries, LLC dba ON Semiconductor or its subsidiaries in the United States and/or other countries. ON Semiconductor owns the rights to a number of patents, trademarks, copyrights, trade secrets, and other intellectual property. A listing of ON Semiconductor's product/patent coverage may be accessed at [www.onsemi.com/site/pdf/Patent-Marking.pdf](http://www.onsemi.com/site/pdf/Patent-Marking.pdf). ON Semiconductor reserves the right to make changes without further notice to any products herein. ON Semiconductor makes no warranty, representation or guarantee regarding the suitability of its products for any particular purpose, nor does ON Semiconductor assume any liability arising out of the application or use of any product or circuit, and specifically disclaims any and all liability, including without limitation special, consequential or incidental damages. Buyer is responsible for its products and applications using ON Semiconductor products, including compliance with all laws, regulations and safety requirements or standards, regardless of any support or applications information provided by ON Semiconductor. "Typical" parameters which may be provided in ON Semiconductor data sheets and/or specifications can and do vary in different applications and actual performance may vary over time. All operating parameters, including "Typicals" must be validated for each customer application by customer's technical experts. ON Semiconductor does not convey any license under its patent rights nor the rights of others. ON Semiconductor products are not designed, intended, or authorized for use as a critical component in life support systems or any FDA Class 3 medical devices or medical devices with a same or similar classification in a foreign jurisdiction or any devices intended for implantation in the human body. Should Buyer purchase or use ON Semiconductor products for any such unintended or unauthorized application, Buyer shall indemnify and hold ON Semiconductor and its officers, employees, subsidiaries, affiliates, and distributors harmless against all claims, costs, damages, and expenses, and reasonable attorney fees arising out of, directly or indirectly, any claim of personal injury or death associated with such unintended or unauthorized use, even if such claim alleges that ON Semiconductor was negligent regarding the design or manufacture of the part. ON Semiconductor is an Equal Opportunity/Affirmative Action Employer. This literature is subject to all applicable copyright laws and is not for resale in any manner.

## PUBLICATION ORDERING INFORMATION

### LITERATURE FULFILLMENT:

Literature Distribution Center for ON Semiconductor  
19521 E. 32nd Pkwy, Aurora, Colorado 80011 USA  
**Phone:** 303-675-2175 or 800-344-3860 Toll Free USA/Canada  
**Fax:** 303-675-2176 or 800-344-3867 Toll Free USA/Canada  
**Email:** [orderlit@onsemi.com](mailto:orderlit@onsemi.com)

**N. American Technical Support:** 800-282-9855 Toll Free  
USA/Canada  
**Europe, Middle East and Africa Technical Support:**  
Phone: 421 33 790 2910  
**Japan Customer Focus Center**  
Phone: 81-3-5817-1050

**ON Semiconductor Website:** [www.onsemi.com](http://www.onsemi.com)  
**Order Literature:** <http://www.onsemi.com/orderlit>  
For additional information, please contact your local  
Sales Representative