



Is Now Part of



ON Semiconductor®

To learn more about ON Semiconductor, please visit our website at

www.onsemi.com

ON Semiconductor and the ON Semiconductor logo are trademarks of Semiconductor Components Industries, LLC dba ON Semiconductor or its subsidiaries in the United States and/or other countries. ON Semiconductor owns the rights to a number of patents, trademarks, copyrights, trade secrets, and other intellectual property. A listing of ON Semiconductor's product/patent coverage may be accessed at www.onsemi.com/site/pdf/Patent-Marking.pdf. ON Semiconductor reserves the right to make changes without further notice to any products herein. ON Semiconductor makes no warranty, representation or guarantee regarding the suitability of its products for any particular purpose, nor does ON Semiconductor assume any liability arising out of the application or use of any product or circuit, and specifically disclaims any and all liability, including without limitation special, consequential or incidental damages. Buyer is responsible for its products and applications using ON Semiconductor products, including compliance with all laws, regulations and safety requirements or standards, regardless of any support or applications information provided by ON Semiconductor. "Typical" parameters which may be provided in ON Semiconductor data sheets and/or specifications can and do vary in different applications and actual performance may vary over time. All operating parameters, including "Typicals" must be validated for each customer application by customer's technical experts. ON Semiconductor does not convey any license under its patent rights nor the rights of others. ON Semiconductor products are not designed, intended, or authorized for use as a critical component in life support systems or any FDA Class 3 medical devices or medical devices with a same or similar classification in a foreign jurisdiction or any devices intended for implantation in the human body. Should Buyer purchase or use ON Semiconductor products for any such unintended or unauthorized application, Buyer shall indemnify and hold ON Semiconductor and its officers, employees, subsidiaries, affiliates, and distributors harmless against all claims, costs, damages, and expenses, and reasonable attorney fees arising out of, directly or indirectly, any claim of personal injury or death associated with such unintended or unauthorized use, even if such claim alleges that ON Semiconductor was negligent regarding the design or manufacture of the part. ON Semiconductor is an Equal Opportunity/Affirmative Action Employer. This literature is subject to all applicable copyright laws and is not for resale in any manner.

FODM452, FODM453

5-Pin Mini Flat Package High Speed Transistor Optocoupler

Features

- Compact 5-pin mini flat package
- High speed-1 MBit/s
- Superior CMR-15kV/μs at $V_{CM} = 1500V$ (FODM453)
- Performance guaranteed over temperature (0–70°C)
- U.L. recognized (File # E90700)
- VDE0884 recognized (File # 136480)
 - Ordering option V, e.g., FODM452V
- 260°C reflow capability for Pb-free assembly

Applications

- Line receivers
- Pulse transformer replacement
- Output interface to CMOS-LSTTL-TTL
- Wide bandwidth analog coupling

Description

The FODM452 and FODM453 optocouplers consist of an AlGaAs LED optically coupled to a high speed photo-detector transistor. The devices are housed in a compact 5-pin mini flat package for optimum mounting density. The FODM453 features a high CMR rating for optimum common mode transient immunity.

Related Resources

- www.fairchildsemi.com/products/opto/
- www.fairchildsemi.com/pf/FO/FODM611.html
- www.fairchildsemi.com/pf/FO/FODM8061.html
- www.fairchildsemi.com/pf/FO/FODM8071.html

Functional Schematic

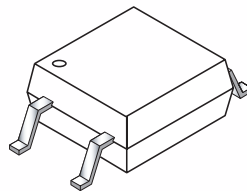
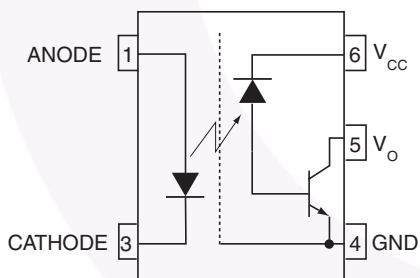

Truth Table

LED	Output
Off	High
On	Low

Pin Definitions

Number	Name	Function Description
1	ANODE	Anode
3	CATHODE	Cathode
4	GND	Output Ground
5	V_O	Output Voltage
6	V_{CC}	Output Supply Voltage

Safety and Insulation Ratings for Mini-Flat Package (SO5 Pin)

As per IEC60747-5-2 (Pending Certification). This optocoupler is suitable for “safe electrical insulation” only within the safety limit data. Compliance with the safety ratings shall be ensured by means of protective circuits.

Symbol	Parameter	Min.	Typ.	Max.	Unit
	Installation Classifications per DIN VDE 0110/1.89 Table 1				
	For rated main voltage < 150Vrms		I-IV		
	For rated main voltage < 300Vrms		I-III		
	Climatic Classification		40/85/21		
	Pollution Degree (DIN VDE 0110/1.89)		2		
CTI	Comparative Tracking Index	175			
V_{PR}	Input to Output Test Voltage, Method b, $V_{IORM} \times 1.875 = V_{PR}$, 100% Production Test with $t_m = 1$ sec, Partial Discharge < 5 pC	1060			
V_{PR}	Input to Output Test Voltage, Method a, $V_{IORM} \times 1.5 = V_{PR}$, Type and Sample Test with $t_m = 60$ sec, Partial Discharge < 5 pC	848			
V_{IORM}	Max Working Insulation Voltage	565			V_{peak}
V_{IOTM}	Highest Allowable Over Voltage	4000			V_{peak}
	External Creepage	5.0			mm
	External Clearance	5.0			mm
	Insulation thickness	0.5			mm
T_{Case}	Safety Limit Values, Maximum Values allowed in the event of a failure, Case Temperature	150			°C
R_{IO}	Insulation Resistance at T_S , $V_{IO} = 500V$	10^9			Ω

Absolute Maximum Ratings ($T_A = 25^\circ\text{C}$ unless otherwise noted)

Stresses exceeding the absolute maximum ratings may damage the device. The device may not function or be operable above the recommended operating conditions and stressing the parts to these levels is not recommended. In addition, extended exposure to stresses above the recommended operating conditions may affect device reliability. The absolute maximum ratings are stress ratings only.

Symbol	Parameter	Value	Units
T_{STG}	Storage Temperature	-40 to +125	$^\circ\text{C}$
T_{OPR}	Operating Temperature	-40 to +85	$^\circ\text{C}$
EMITTER			
I_F (avg)	DC/Average Forward Input Current	25	mA
I_F (pk)	Peak Forward Input Current (50% duty cycle, 1ms P.W.)	50	mA
I_F (trans)	Peak Transient Input Current ($\leq 1\mu\text{s}$ P.W., 300pps)	1.0	A
V_R	Reverse Input Voltage	5	V
P_D	Input Power Dissipation (No derating required over specified operating temp range)	45	mW
DETECTOR			
I_O (avg)	Average Output Current	8	mA
I_O (pk)	Peak Output Current	16	mA
V_{CC}	Supply Voltage	-0.5 to 30	V
V_O	Output Voltage	-0.5 to 20	V
P_D	Output Power Dissipation (No derating required over specified operating temp range)	100	mW

Electrical Characteristics (T_A = 0 to 70°C unless otherwise specified)

Individual Component Characteristics

Symbol	Parameter	Test Conditions	Min.	Typ.*	Max.	Unit
EMITTER						
V _F	Input Forward Voltage	I _F = 16mA, T _A = 25°C		1.60	1.7	V
		I _F = 16mA			1.8	
B _{VR}	Input Reverse Breakdown Voltage	I _R = 10μA	5.0			V
ΔV _F /ΔT _A	Temperature Coefficient of Forward Voltage	I _F = 16mA		-1.8		mV/°C
DETECTOR						
I _{OH}	Logic High Output Current	I _F = 0mA, V _O = V _{CC} = 5.5V, T _A = 25°C		.001	0.5	μA
		I _F = 0 mA, V _O = V _{CC} = 15V, T _A = 25°C		.001	1	
		I _F = 0mA, V _O = V _{CC} = 15V			50	
I _{CCL}	Logic Low Supply Current	I _F = 16mA, V _O = Open, V _{CC} = 15V		100	200	μA
I _{CCH}	Logic high supply current	I _F = 0 mA, V _O = Open, V _{CC} = 15V, T _A = 25°C		0.05	1	μA
		I _F = 0mA, V _O = Open, V _{CC} = 15V			2	

Transfer Characteristics

Symbol	Parameter	Test Conditions	Min.	Typ.*	Max	Unit	
COUPLED							
CTR	Current Transfer Ratio ⁽¹⁾	I _F = 16mA, V _{CC} = 4.5V	T _A = 25°C V _{OL} =0.4V	20		50	%
			V _{OL} =0.5V	15			
V _{OL}	Logic LOW Output Voltage	I _F = 16mA, I _O = 3mA, V _{CC} = 4.5V, T _A = 25°C			0.4	V	
		I _F = 16mA, I _O = 2.4mA, V _{CC} = 4.5 V			0.5		

Switching Characteristics (V_{CC} = 5V)

Symbol	Parameter	Test Conditions	Device	Min.	Typ.*	Max.	Unit
T _{PHL}	Propagation Delay Time to Logic LOW	R _L = 1.9kΩ, I _F = 16mA, T _A = 25°C ⁽²⁾ (Fig. 9)			0.40	0.8	μs
		R _L = 1.9kΩ, I _F = 16mA ⁽²⁾ (Fig. 9)				1.0	
T _{PLH}	Propagation Delay Time to Logic HIGH	R _L = 1.9kΩ, I _F = 16mA, T _A = 25°C ⁽²⁾ (Fig. 9)			0.35	0.8	μs
		R _L = 1.9kΩ, I _F = 16mA ⁽²⁾ (Fig. 9)				1.0	
CM _H	Common Mode Transient Immunity at Logic HIGH	I _F = 0mA, V _{CM} = 10V _{P-P} , R _L = 1.9kΩ, T _A = 25°C ⁽³⁾ (Fig. 10)	FODM452	5	15		KV/μs
		I _F = 0mA, V _{CM} = 1500V _{P-P} , R _L = 1.9kΩ, T _A = 25°C ⁽³⁾ (Fig. 10)	FODM453	15	40		KV/μs
CM _L	Common Mode Transient Immunity at Logic LOW	I _F = 16mA, V _{CM} = 10V _{P-P} , R _L = 1.9kΩ, T _A = 25°C ⁽³⁾ (Fig. 10)	FODM452	5	15		KV/μs
		I _F = 16mA, V _{CM} = 1500V _{P-P} , R _L = 1.9kΩ, T _A = 25°C ⁽³⁾ (Fig. 10)	FODM453	15	40		KV/μs
BW	Bandwidth	R _L = 100Ω			3		MHz

Isolation Characteristics

Symbol	Characteristics	Test Conditions	Min.	Typ.*	Max.	Unit
V _{ISO}	Withstand Insulation Test Voltage	RH ≤ 50%, T _A = 25°C, t = 1 min. ⁽⁴⁾	3750			V _{RMS}
C _{I-O}	Capacitance (Input to Output)	f = 1MHz ⁽⁴⁾		0.2		pF

*All Typicals at T_A = 25°C

Notes:

1. Current Transfer Ratio is defined as a ratio of output collector current, I_O , to the forward LED input current, I_F , times 100%.
2. The 1.9k Ω load represents 1 TTL unit load of 1.6mA and 5.6k Ω pull-up resistor.
3. Common mode transient immunity in logic high level is the maximum tolerable (positive) dV_{cm}/dt on the leading edge of the common mode pulse signal V_{CM} , to assure that the output will remain in a logic high state (i.e., $V_O > 2.0V$). Common mode transient immunity in logic low level is the maximum tolerable (negative) dV_{cm}/dt on the trailing edge of the common mode pulse signal, V_{CM} , to assure that the output will remain in a logic low state (i.e., $V_O < 0.8V$).
4. Device is considered a two terminal device: Pins 1, and 3 are shorted together and Pins 4, 5, and 6 are shorted together.

Typical Performance Curves

Fig. 1 Input Forward Current vs Forward Voltage

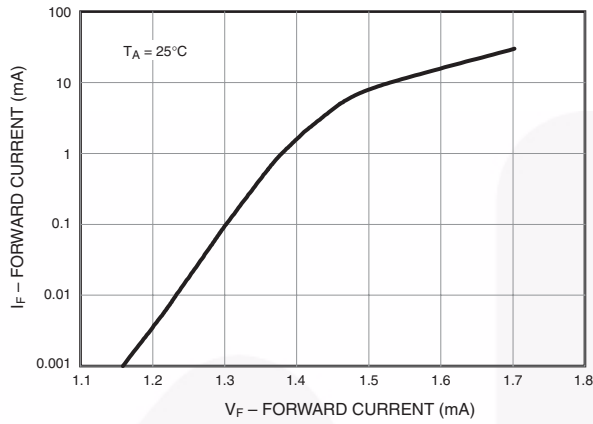

Fig. 2 Normalized Current Transfer Ratio vs. Input Current

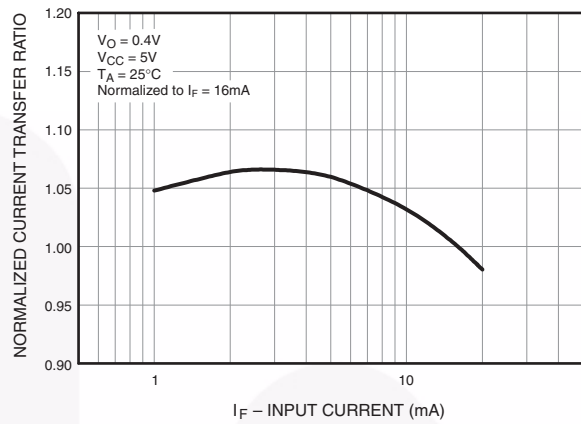

Fig. 3 Normalized Current Transfer Ratio vs. Ambient Temperature

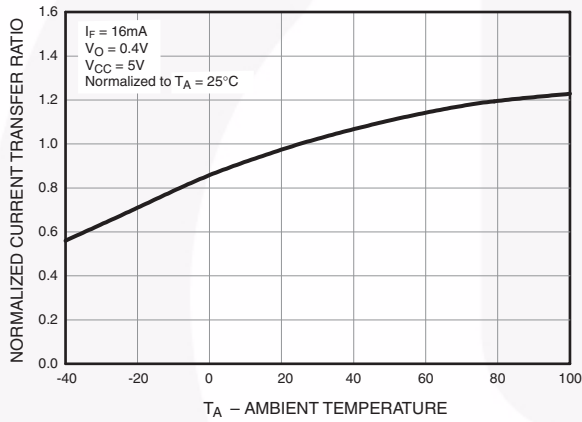

Fig. 4 Logic High Output Current vs. Ambient Temperature

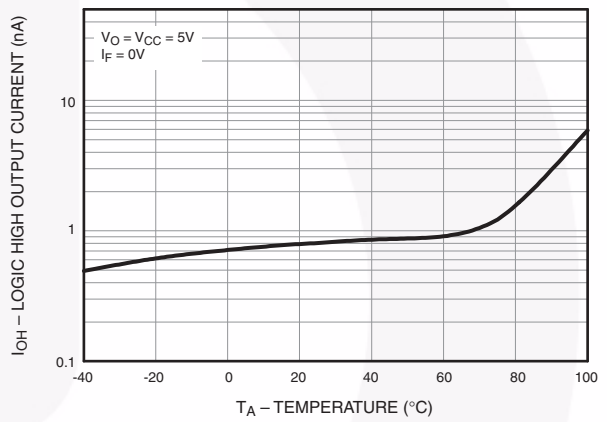

Fig. 5 DC and Pulsed Transfer Characteristics

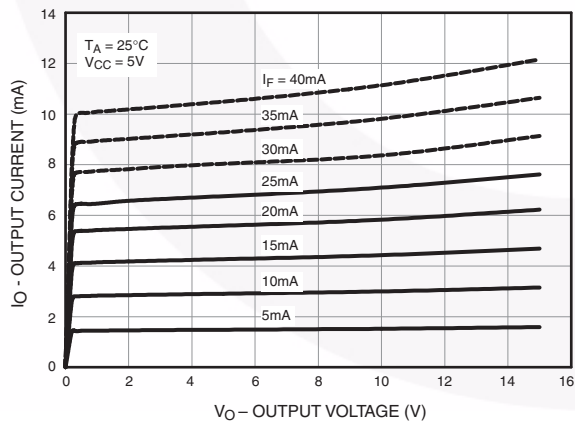
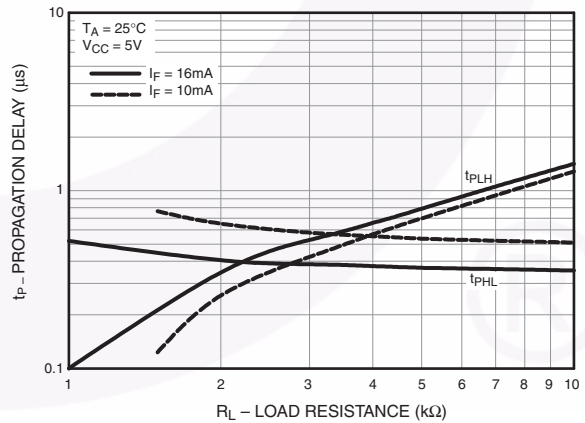

Fig. 6 Propagation Delay vs. Load Resistance



Typical Performance Curves (Continued)

Fig. 7 Propagation Delay vs. Ambient Temperature

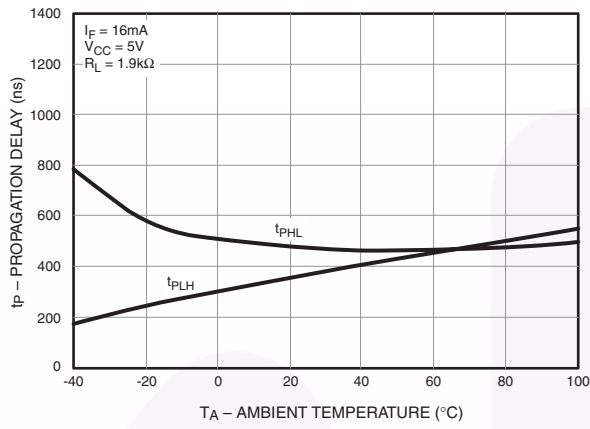
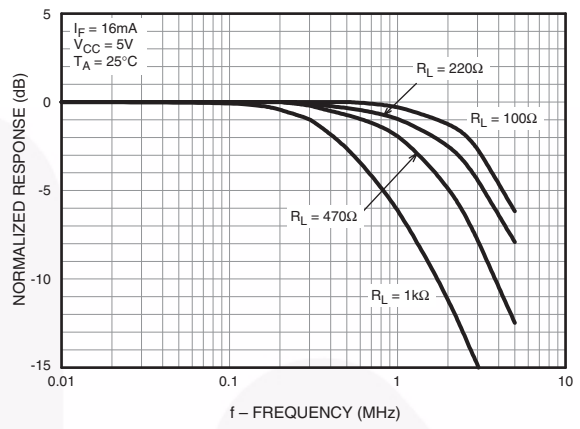

Fig. 8 Frequency Response



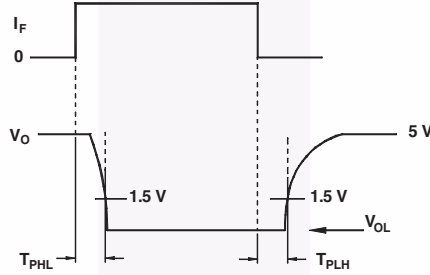
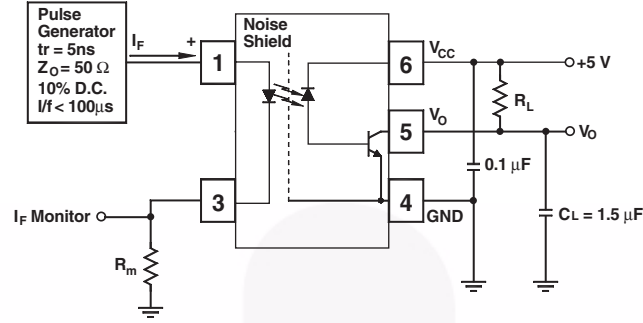
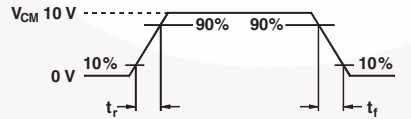
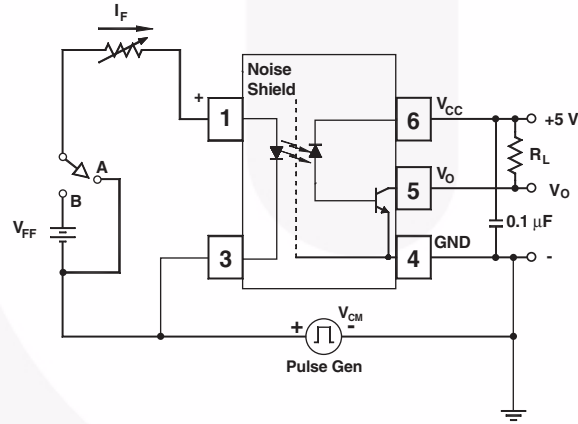

Fig. 9 Switching Time Test Circuit



Switch at A : $I_F = 0 \text{ mA}$



Switch at A : $I_F = 16 \text{ mA}$

Fig. 10 Common Mode Immunity Test Circuit

Package Dimensions

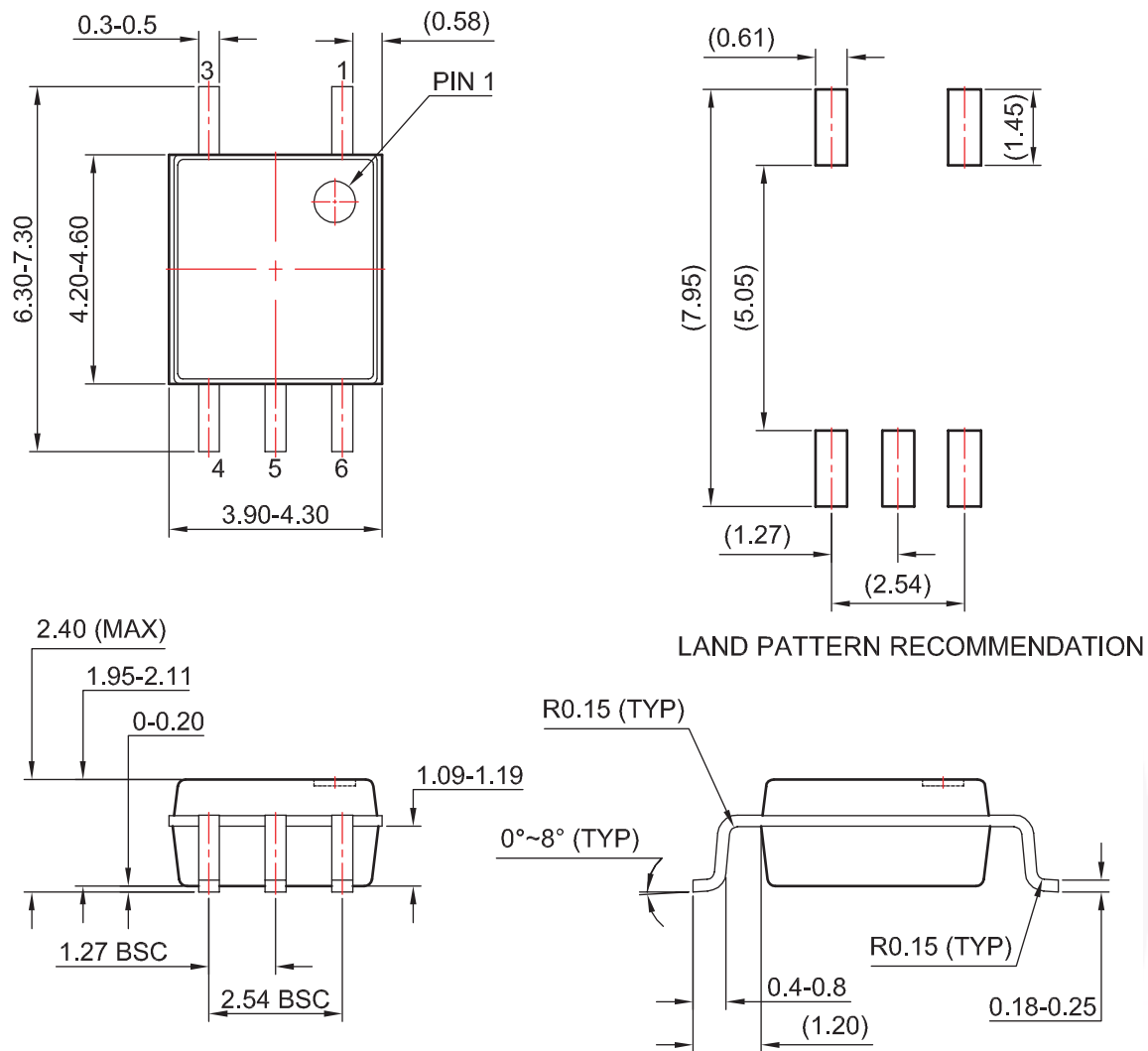

Notes:

1. No standard applies to this package.
2. All dimensions are in millimeters.
3. Dimensions are exclusive of burrs, mold flash, and tie bar extrusion.
4. Drawings filename and revision: MKT-MFP05A.

Package drawings are provided as a service to customers considering Fairchild components. Drawings may change in any manner without notice. Please note the revision and/or date on the drawing and contact a Fairchild Semiconductor representative to verify or obtain the most recent revision. Package specifications do not expand the terms of Fairchild's worldwide terms and conditions, specifically the warranty therein, which covers Fairchild products.

Always visit Fairchild Semiconductor's online packaging area for the most recent package drawings:

<http://www.fairchildsemi.com/packaging/>

Footprint Drawing for PCB Layout

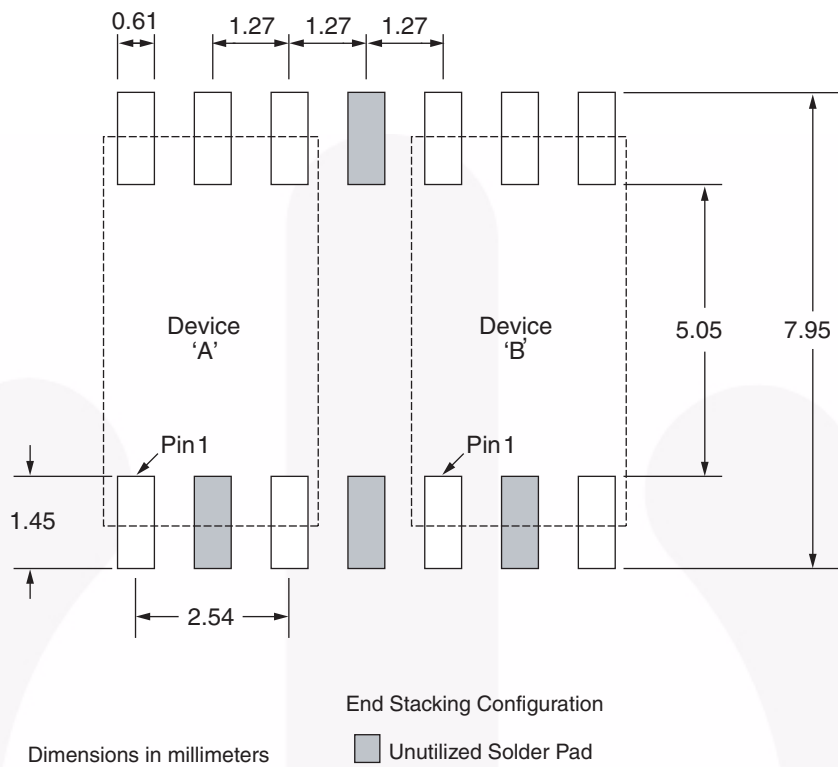

Tape and Reel Dimensions

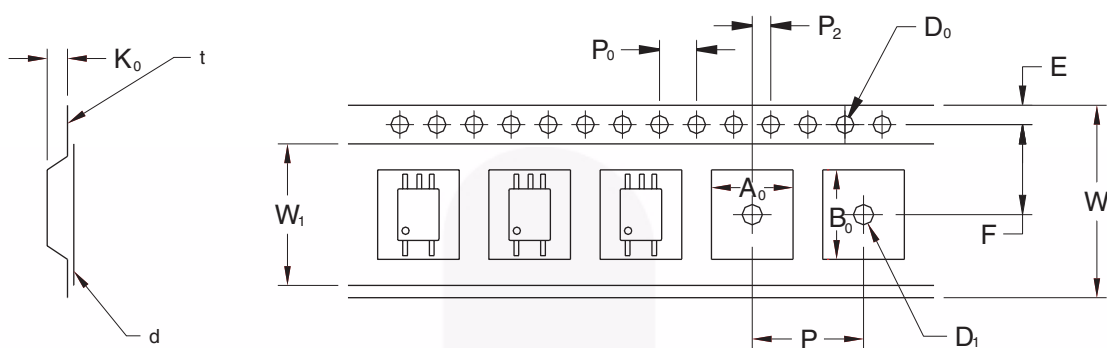

		2.54 Pitch
Description	Symbol	Dimensions (mm)
Tape Width	W	12.00 +0.30/-0.10
Tape Thickness	t	0.30 ±0.05
Sprocket Hole Pitch	P ₀	4.00 ±0.10
Sprocket Hole Diameter	D ₀	1.50 +0.10/-0.0
Sprocket Hole Location	E	1.75 ±0.10
Pocket Location	F	5.50 ±0.10
	P ₂	2.00 ±0.10
Pocket Pitch	P	8.00 ±0.10
Pocket Dimension	A ₀	4.40 ±0.10
	B ₀	7.30 ±0.10
	K ₀	2.30 ±0.10
Pocket Hole Diameter	D ₁	1.50 Min.
Cover Tape Width	W ₁	9.20
Cover Tape Thickness	d	0.065 ±0.010
Max. Component Rotation or Tilt		10° Max.
Devices Per Reel		2500
Reel Diameter		330mm (13")

Ordering Information

Option	Order Entry Identifier (example)	Description
R2	FODM452R2	Tape and Reel (2500 per reel)
V	FODM452V	IEC60747-5-2
R2V	FODM452R2V	IEC60747-5-2, Tape and Reel (2500 per reel)

Marking Information

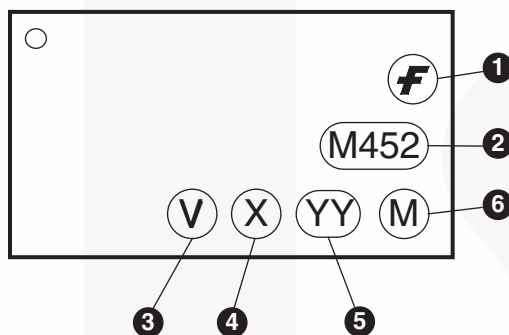

Definitions

1	Fairchild logo
2	Device number
3	IEC60747-5-2 mark (Note: Only appears on parts ordered with VDE option – See order entry table)
4	One digit year code, e.g., '7'
5	Two digit work week ranging from '01' to '53'
6	Assembly package code

Reflow Profile

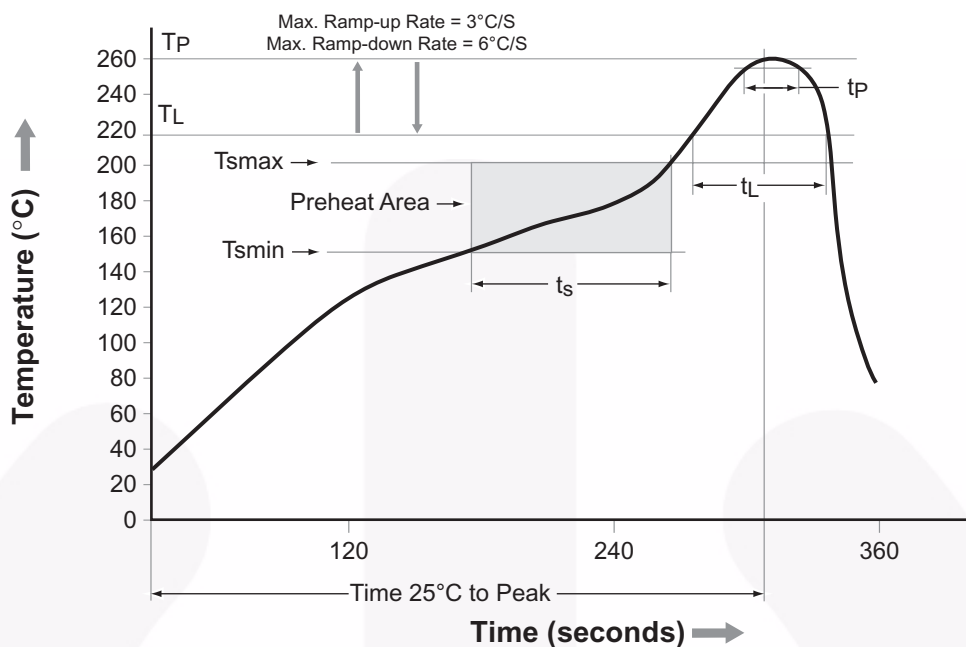





Profile Feature	Pb-Free Assembly Profile
Temperature Min. (Tsmín)	150°C
Temperature Max. (Tsmáx)	200°C
Time (ts) from (Tsmín to Tsmáx)	60–120 seconds
Ramp-up Rate (tL to tp)	3°C/second max.
Liquidous Temperature (TL)	217°C
Time (tL) Maintained Above (TL)	60–150 seconds
Peak Body Package Temperature	260°C +0°C / -5°C
Time (tp) within 5°C of 260°C	30 seconds
Ramp-down Rate (TP to TL)	6°C/second max.
Time 25°C to Peak Temperature	8 minutes max.



TRADEMARKS

The following includes registered and unregistered trademarks and service marks, owned by Fairchild Semiconductor and/or its global subsidiaries, and is not intended to be an exhaustive list of all such trademarks.

- | | | | |
|---|--|---|---|
| AccuPower™ | F-PFS™ | OPTOPLANAR® |  |
| AttitudeEngine™ | FRFET® |  | TinyBoost® |
| Awinda® | Global Power Resource SM | PowerTrench® | TinyBuck® |
| AX-CAP®* | GreenBridge™ | PowerXS™ | TinyCalc™ |
| BitSiC™ | Green FPS™ | PowerXS™ | TinyLogic® |
| Build it Now™ | Green FPS™ e-Series™ | Programmable Active Droop™ | TINYOPTO™ |
| CorePLUS™ | Gmax™ | QFET® | TinyPower™ |
| CorePOWER™ | GTO™ | QS™ | TinyPWM™ |
| CROSSVOL™ | IntelliMAX™ | Quiet Series™ | TinyWire™ |
| CTL™ | ISOPLANAR™ | RapidConfigure™ | TranSiC™ |
| Current Transfer Logic™ | Making Small Speakers Sound Louder and Better™ |  | TriFault Detect™ |
| DEUXPEED® | MegaBuck™ | Saving our world, 1mW/W/kW at a time™ | TRUECURRENT®* |
| Dual Cool™ | MICROCOUPLER™ | SignalWise™ | μSerDes™ |
| EcoSPARK® | MicroFET™ | SmartMax™ |  |
| EfficientMax™ | MicroPak™ | SMART START™ | UHC® |
| ESBC™ | MicroPak2™ | Solutions for Your Success™ | Ultra FRFET™ |
|  | MillerDrive™ | SPM® | UniFET™ |
| Fairchild® | MotionMax™ | STEALTH™ | VCX™ |
| Fairchild Semiconductor® | MotionGrid® | SuperFET® | VisualMax™ |
| FACT Quiet Series™ | MTi® | SuperSOT™-3 | VoltagePlus™ |
| FACT® | MTx® | SuperSOT™-6 | XST™ |
| FastvCore™ | MVN® | SupreMOS® | Xsens™ |
| FETBench™ | mWSaver® | SyncFET™ | 仙童™ |
| FPS™ | OptoHiT™ | Sync-Lock™ | |
| | OPTOLOGIC® | | |

* Trademarks of System General Corporation, used under license by Fairchild Semiconductor.

DISCLAIMER

FAIRCHILD SEMICONDUCTOR RESERVES THE RIGHT TO MAKE CHANGES WITHOUT FURTHER NOTICE TO ANY PRODUCTS HEREIN TO IMPROVE RELIABILITY, FUNCTION, OR DESIGN. TO OBTAIN THE LATEST, MOST UP-TO-DATE DATASHEET AND PRODUCT INFORMATION, VISIT OUR WEBSITE AT [HTTP://WWW.FAIRCHILDSEMI.COM](http://www.fairchildsemi.com). FAIRCHILD DOES NOT ASSUME ANY LIABILITY ARISING OUT OF THE APPLICATION OR USE OF ANY PRODUCT OR CIRCUIT DESCRIBED HEREIN; NEITHER DOES IT CONVEY ANY LICENSE UNDER ITS PATENT RIGHTS, NOR THE RIGHTS OF OTHERS. THESE SPECIFICATIONS DO NOT EXPAND THE TERMS OF FAIRCHILD'S WORLDWIDE TERMS AND CONDITIONS, SPECIFICALLY THE WARRANTY THEREIN, WHICH COVERS THESE PRODUCTS.

AUTHORIZED USE

Unless otherwise specified in this data sheet, this product is a standard commercial product and is not intended for use in applications that require extraordinary levels of quality and reliability. This product may not be used in the following applications, unless specifically approved in writing by a Fairchild officer: (1) automotive or other transportation, (2) military/aerospace, (3) any safety critical application – including life critical medical equipment – where the failure of the Fairchild product reasonably would be expected to result in personal injury, death or property damage. Customer's use of this product is subject to agreement of this Authorized Use policy. In the event of an unauthorized use of Fairchild's product, Fairchild accepts no liability in the event of product failure. In other respects, this product shall be subject to Fairchild's Worldwide Terms and Conditions of Sale, unless a separate agreement has been signed by both Parties.

ANTI-COUNTERFEITING POLICY

Fairchild Semiconductor Corporation's Anti-Counterfeiting Policy. Fairchild's Anti-Counterfeiting Policy is also stated on our external website, www.fairchildsemi.com, under Terms of Use

Counterfeiting of semiconductor parts is a growing problem in the industry. All manufacturers of semiconductor products are experiencing counterfeiting of their parts. Customers who inadvertently purchase counterfeit parts experience many problems such as loss of brand reputation, substandard performance, failed applications, and increased cost of production and manufacturing delays. Fairchild is taking strong measures to protect ourselves and our customers from the proliferation of counterfeit parts. Fairchild strongly encourages customers to purchase Fairchild parts either directly from Fairchild or from Authorized Fairchild Distributors who are listed by country on our web page cited above. Products customers buy either from Fairchild directly or from Authorized Fairchild Distributors are genuine parts, have full traceability, meet Fairchild's quality standards for handling and storage and provide access to Fairchild's full range of up-to-date technical and product information. Fairchild and our Authorized Distributors will stand behind all warranties and will appropriately address any warranty issues that may arise. Fairchild will not provide any warranty coverage or other assistance for parts bought from Unauthorized Sources. Fairchild is committed to combat this global problem and encourage our customers to do their part in stopping this practice by buying direct or from authorized distributors.

PRODUCT STATUS DEFINITIONS

Definition of Terms

Datasheet Identification	Product Status	Definition
Advance Information	Formative / In Design	Datasheet contains the design specifications for product development. Specifications may change in any manner without notice.
Preliminary	First Production	Datasheet contains preliminary data; supplementary data will be published at a later date. Fairchild Semiconductor reserves the right to make changes at any time without notice to improve design.
No Identification Needed	Full Production	Datasheet contains final specifications. Fairchild Semiconductor reserves the right to make changes at any time without notice to improve the design.
Obsolete	Not In Production	Datasheet contains specifications on a product that is discontinued by Fairchild Semiconductor. The datasheet is for reference information only.

Rev. I76

ON Semiconductor and  are trademarks of Semiconductor Components Industries, LLC dba ON Semiconductor or its subsidiaries in the United States and/or other countries. ON Semiconductor owns the rights to a number of patents, trademarks, copyrights, trade secrets, and other intellectual property. A listing of ON Semiconductor's product/patent coverage may be accessed at www.onsemi.com/site/pdf/Patent-Marking.pdf. ON Semiconductor reserves the right to make changes without further notice to any products herein. ON Semiconductor makes no warranty, representation or guarantee regarding the suitability of its products for any particular purpose, nor does ON Semiconductor assume any liability arising out of the application or use of any product or circuit, and specifically disclaims any and all liability, including without limitation special, consequential or incidental damages. Buyer is responsible for its products and applications using ON Semiconductor products, including compliance with all laws, regulations and safety requirements or standards, regardless of any support or applications information provided by ON Semiconductor. "Typical" parameters which may be provided in ON Semiconductor data sheets and/or specifications can and do vary in different applications and actual performance may vary over time. All operating parameters, including "Typicals" must be validated for each customer application by customer's technical experts. ON Semiconductor does not convey any license under its patent rights nor the rights of others. ON Semiconductor products are not designed, intended, or authorized for use as a critical component in life support systems or any FDA Class 3 medical devices or medical devices with a same or similar classification in a foreign jurisdiction or any devices intended for implantation in the human body. Should Buyer purchase or use ON Semiconductor products for any such unintended or unauthorized application, Buyer shall indemnify and hold ON Semiconductor and its officers, employees, subsidiaries, affiliates, and distributors harmless against all claims, costs, damages, and expenses, and reasonable attorney fees arising out of, directly or indirectly, any claim of personal injury or death associated with such unintended or unauthorized use, even if such claim alleges that ON Semiconductor was negligent regarding the design or manufacture of the part. ON Semiconductor is an Equal Opportunity/Affirmative Action Employer. This literature is subject to all applicable copyright laws and is not for resale in any manner.

PUBLICATION ORDERING INFORMATION

LITERATURE FULFILLMENT:

Literature Distribution Center for ON Semiconductor
19521 E. 32nd Pkwy, Aurora, Colorado 80011 USA
Phone: 303-675-2175 or 800-344-3860 Toll Free USA/Canada
Fax: 303-675-2176 or 800-344-3867 Toll Free USA/Canada
Email: orderlit@onsemi.com

N. American Technical Support: 800-282-9855 Toll Free
USA/Canada
Europe, Middle East and Africa Technical Support:
Phone: 421 33 790 2910
Japan Customer Focus Center
Phone: 81-3-5817-1050

ON Semiconductor Website: www.onsemi.com
Order Literature: <http://www.onsemi.com/orderlit>
For additional information, please contact your local
Sales Representative