



Is Now Part of



**ON Semiconductor®**

To learn more about ON Semiconductor, please visit our website at

[www.onsemi.com](http://www.onsemi.com)

ON Semiconductor and the ON Semiconductor logo are trademarks of Semiconductor Components Industries, LLC dba ON Semiconductor or its subsidiaries in the United States and/or other countries. ON Semiconductor owns the rights to a number of patents, trademarks, copyrights, trade secrets, and other intellectual property. A listing of ON Semiconductor's product/patent coverage may be accessed at [www.onsemi.com/site/pdf/Patent-Marking.pdf](http://www.onsemi.com/site/pdf/Patent-Marking.pdf). ON Semiconductor reserves the right to make changes without further notice to any products herein. ON Semiconductor makes no warranty, representation or guarantee regarding the suitability of its products for any particular purpose, nor does ON Semiconductor assume any liability arising out of the application or use of any product or circuit, and specifically disclaims any and all liability, including without limitation special, consequential or incidental damages. Buyer is responsible for its products and applications using ON Semiconductor products, including compliance with all laws, regulations and safety requirements or standards, regardless of any support or applications information provided by ON Semiconductor. "Typical" parameters which may be provided in ON Semiconductor data sheets and/or specifications can and do vary in different applications and actual performance may vary over time. All operating parameters, including "Typicals" must be validated for each customer application by customer's technical experts. ON Semiconductor does not convey any license under its patent rights nor the rights of others. ON Semiconductor products are not designed, intended, or authorized for use as a critical component in life support systems or any FDA Class 3 medical devices or medical devices with a same or similar classification in a foreign jurisdiction or any devices intended for implantation in the human body. Should Buyer purchase or use ON Semiconductor products for any such unintended or unauthorized application, Buyer shall indemnify and hold ON Semiconductor and its officers, employees, subsidiaries, affiliates, and distributors harmless against all claims, costs, damages, and expenses, and reasonable attorney fees arising out of, directly or indirectly, any claim of personal injury or death associated with such unintended or unauthorized use, even if such claim alleges that ON Semiconductor was negligent regarding the design or manufacture of the part. ON Semiconductor is an Equal Opportunity/Affirmative Action Employer. This literature is subject to all applicable copyright laws and is not for resale in any manner.

# FODM8801A, FODM8801B, FODM8801C

## OptoHiT™ Series, High-Temperature Phototransistor Optocoupler in Half-Pitch Mini-Flat 4-Pin Package

### Features

- Utilizing Proprietary Process Technology to Achieve High Operating Temperature: up to 125°C
- Guaranteed Current Transfer Ratio (CTR) Specifications Across Full Temperature Range
  - Excellent CTR Linearity at High-Temperature
  - CTR at Very Low Input Current,  $I_F$
- High Isolation Voltage Regulated by Safety Agency: C-UL / UL1577, 3750 VAC<sub>RMS</sub> for 1 minute and DIN EN/IEC60747-5-5
- Compact Half-Pitch, Mini-Flat, 4-Pin Package (1.27 mm Lead Pitch, 2.4 mm Maximum Standoff Height)
- > 5 mm Creepage and Clearance Distance
- Applicable to Infrared Ray Reflow, 245°C

### Applications

- Primarily Suited for DC-DC Converters
- Ground-Loop Isolation, Signal-Noise Isolation
- Communications – Adapters, Chargers
- Consumer – Appliances, Set-Top Boxes
- Industrial – Power Supplies, Motor Control, Programmable Logic Control

### Description

In the OptoHiT™ series, the FODM8801 is a first-of-kind phototransistor, utilizing Fairchild's leading-edge proprietary process technology to achieve high operating temperature characteristics, up to 125°C. The optocoupler consists of an aluminum gallium arsenide (AlGaAs) infrared light-emitting diode (LED) optically coupled to a phototransistor, available in a compact half-pitch, mini-flat, 4-pin package. It delivers high current transfer ratio at very low input current. The input-output isolation voltage,  $V_{ISO}$ , is rated at 3750 VAC<sub>RMS</sub>.

### Schematic

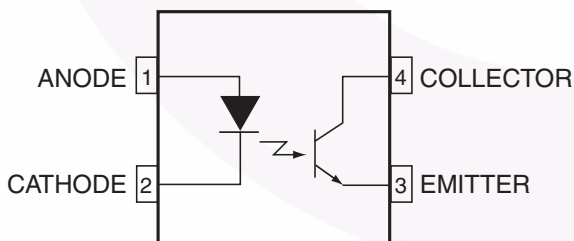


Figure 1. Schematic

### Package

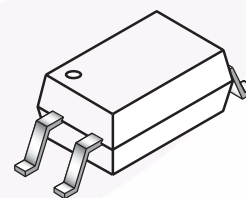


Figure 2. Half-Pitch Mini-Flat

## Safety and Insulation Ratings

As per DIN EN/IEC 60747-5-5, this optocoupler is suitable for “safe electrical insulation” only within the safety limit data. Compliance with the safety ratings shall be ensured by means of protective circuits.

| Parameter   |                        | Characteristics |
|---|------------------------|-----------------|
| Installation Classifications per DIN VDE 0110/1.89 Table 1, For Rated Mains Voltage | < 150 V <sub>RMS</sub> | I–IV            |
|   | < 300 V <sub>RMS</sub> | I–III           |
| Climatic Classification   |                        | 40/125/21       |
| Pollution Degree (DIN VDE 0110/1.89)  |                        | 2               |
| Comparative Tracking Index  |                        | 175             |

| Symbol                | Parameter  | Value             | Unit              |
|-----------------------|--|-------------------|-------------------|
| V <sub>PR</sub>       | Input-to-Output Test Voltage, Method A, V <sub>IORM</sub> × 1.6 = V <sub>PR</sub> , Type and Sample Test with t <sub>m</sub> = 10 s, Partial Discharge < 5 pC  | 848               | V <sub>peak</sub> |
|                       | Input-to-Output Test Voltage, Method B, V <sub>IORM</sub> × 1.875 = V <sub>PR</sub> , 100% Production Test with t <sub>m</sub> = 1 s, Partial Discharge < 5 pC | 1060              | V <sub>peak</sub> |
| V <sub>IORM</sub>     | Maximum Working Insulation Voltage   | 565               | V <sub>peak</sub> |
| V <sub>IOTM</sub>     | Highest Allowable Over-Voltage   | 6000              | V <sub>peak</sub> |
|                       | External Creepage  | ≥ 5               | mm                |
|                       | External Clearance   | ≥ 5               | mm                |
| DTI                   | Distance Through Insulation (Insulation Thickness)   | ≥ 0.5             | mm                |
| T <sub>S</sub>        | Case Temperature <sup>(1)</sup>  | 150               | °C                |
| I <sub>S,INPUT</sub>  | Input Current <sup>(1)</sup>   | 200               | mA                |
| P <sub>S,OUTPUT</sub> | Output Power <sup>(1)</sup>  | 300               | mW                |
| R <sub>IO</sub>       | Insulation Resistance at T <sub>S</sub> , V <sub>IO</sub> = 500 V <sup>(1)</sup>   | > 10 <sup>9</sup> | Ω                 |

### Note:

1. Safety limit values – maximum values allowed in the event of a failure.

## Absolute Maximum Ratings

Stresses exceeding the absolute maximum ratings may damage the device. The device may not function or be operable above the recommended operating conditions and stressing the parts to these levels is not recommended. In addition, extended exposure to stresses above the recommended operating conditions may affect device reliability. The absolute maximum ratings are stress ratings only.  $T_A = 25^\circ\text{C}$  unless otherwise specified.

| Symbol                   | Parameter                                     | Value        | Unit             |
|--------------------------|---|--------------|------------------|
| <b>Total Package</b>     |   |              |                  |
| $T_{\text{STG}}$         | Storage Temperature                           | -40 to +150  | $^\circ\text{C}$ |
| $T_{\text{OPR}}$         | Operating Temperature                         | -40 to +125  | $^\circ\text{C}$ |
| $T_J$                    | Junction Temperature                          | -40 to +140  | $^\circ\text{C}$ |
| $T_{\text{SOL}}$         | Lead Solder Temperature                       | 245 for 10 s | $^\circ\text{C}$ |
| <b>Emitter</b>           |   |              |                  |
| $I_{\text{F(average)}}$  | Continuous Forward Current                    | 20           | mA               |
| $V_R$                    | Reverse Input Voltage                         | 6            | V                |
| $\text{PD}_{\text{LED}}$ | Power Dissipation <sup>(2)(4)</sup>           | 40           | mW               |
| <b>Detector</b>          |   |              |                  |
| $I_{\text{C(average)}}$  | Continuous Collector Current                  | 30           | mA               |
| $V_{\text{CEO}}$         | Collector-Emitter Voltage                     | 75           | V                |
| $V_{\text{ECO}}$         | Emitter-Collector Voltage                     | 7            | V                |
| $\text{PD}_{\text{C}}$   | Collector Power Dissipation <sup>(3)(4)</sup> | 150          | mW               |

### Notes:

- Derate linearly from  $73^\circ\text{C}$  at a rate of  $0.24 \text{ mW}/^\circ\text{C}$
- Derate linearly from  $73^\circ\text{C}$  at a rate of  $2.23 \text{ mW}/^\circ\text{C}$ .
- Functional operation under these conditions is not implied. Permanent damage may occur if the device is subjected to conditions outside these ratings.

## Recommended Operating Conditions

The Recommended Operating Conditions table defines the conditions for actual device operation. Recommended operating conditions are specified to ensure optimal performance to the datasheet specifications. Fairchild does not recommend exceeding them or designing to absolute maximum ratings.

| Symbol               | Parameter                  | Value        | Unit             |
|----------------------|----------------------------|--------------|------------------|
| $T_A$                | Operating Temperature      | -40 to +125  | $^\circ\text{C}$ |
| $V_{\text{FL(OFF)}}$ | Input Low Voltage          | -5.0 to +0.8 | V                |
| $I_{\text{FH}}$      | Input High Forward Current | 1 to 10      | mA               |

## Isolation Characteristics

| Symbol           | Parameter                      | Conditions  | Min.      | Typ. | Max. | Unit                      |
|------------------|--------------------------------|---|-----------|------|------|---------------------------|
| $V_{\text{ISO}}$ | Input-Output Isolation Voltage | $f = 60 \text{ Hz}$ , $t = 1 \text{ min.}$ , $I_{\text{I-O}} \leq 10 \mu\text{A}$ <sup>(5)(6)</sup> | 3,750     |      |      | $\text{VAC}_{\text{RMS}}$ |
| $R_{\text{ISO}}$ | Isolation Resistance           | $V_{\text{I-O}} = 500 \text{ V}$ <sup>(5)</sup>   | $10^{12}$ |      |      | $\Omega$                  |
| $C_{\text{ISO}}$ | Isolation Capacitance          | $f = 1 \text{ MHz}$   |           | 0.3  | 0.5  | pF                        |

### Notes:

- Device is considered a two-terminal device: pins 1 and 2 are shorted together and pins 3 and 4 are shorted together.
- $3,750 \text{ VAC}_{\text{RMS}}$  for 1 minute is equivalent to  $4,500 \text{ VAC}_{\text{RMS}}$  for 1 second.

## Electrical Characteristics

Apply over all recommended conditions ( $T_A = -40^\circ\text{C}$  to  $+125^\circ\text{C}$  unless otherwise specified).  
All typical values are measured at  $T_A = 25^\circ\text{C}$ .

| Symbol                    | Parameter                           | Conditions  | Min. | Typ. | Max. | Unit          |
|---------------------------|-------------------------------------|---|------|------|------|---------------|
| <b>Emitter</b>            |                                     |   |      |      |      |               |
| $V_F$                     | Forward Voltage                     | $I_F = 1\text{ mA}$   | 1.00 | 1.35 | 1.80 | V             |
| $\Delta V_F / \Delta T_A$ | Forward-Voltage Coefficient         | $I_F = 1\text{ mA}$   |      | -1.6 |      | mV / °C       |
| $I_R$                     | Reverse Current                     | $V_R = 6\text{ V}$  |      |      | 10   | $\mu\text{A}$ |
| $C_T$                     | Terminal Capacitance                | $V = 0\text{ V}, f = 1\text{ MHz}$                                |      | 30   |      | pF            |
| <b>Detector</b>           |                                     |   |      |      |      |               |
| $BV_{CEO}$                | Collector-Emitter Breakdown Voltage | $I_C = 0.5\text{ mA}, I_F = 0\text{ mA}$                          | 75   | 130  |      | V             |
| $BV_{ECO}$                | Emitter-Collector Breakdown Voltage | $I_E = 100\text{ }\mu\text{A}, I_F = 0\text{ mA}$                 | 7    | 12   |      | V             |
| $I_{CEO}$                 | Collector Dark Current              | $V_{CE} = 75\text{ V}, I_F = 0\text{ mA}, T_A = 25^\circ\text{C}$ |      |      | 100  | nA            |
|                           |                                     | $V_{CE} = 50\text{ V}, I_F = 0\text{ mA}$                         |      |      | 50   | $\mu\text{A}$ |
|                           |                                     | $V_{CE} = 5\text{ V}, I_F = 0\text{ mA}$                          |      |      | 30   | $\mu\text{A}$ |
| $C_{CE}$                  | Capacitance                         | $V_{CE} = 0\text{ V}, f = 1\text{ MHz}$                           |      | 8    |      | pF            |

### Transfer Characteristics

Apply over all recommended conditions ( $T_A = -40^{\circ}\text{C}$  to  $+125^{\circ}\text{C}$  unless otherwise specified).  
 All typical values are measured at  $T_A = 25^{\circ}\text{C}$ .

| Symbol                 | Parameter   | Device    | Conditions  | Min. | Typ. | Max. | Unit |
|------------------------|---|-----------|---|------|------|------|------|
| CTR <sub>CE</sub>      | Current Transfer Ratio<br>(Collector-Emitter)           | FODM8801A | I <sub>F</sub> = 1.0 mA, V <sub>CE</sub> = 5 V<br>@ T <sub>A</sub> = 25°C   | 80   | 120  | 160  | %    |
|                        |   |           | I <sub>F</sub> = 1.0 mA, V <sub>CE</sub> = 5 V                              | 35   | 120  | 230  |      |
|                        |   |           | I <sub>F</sub> = 1.6 mA, V <sub>CE</sub> = 5 V                              | 40   | 125  |      |      |
|                        |   |           | I <sub>F</sub> = 3.0 mA, V <sub>CE</sub> = 5 V                              | 45   | 138  |      |      |
|                        |   | FODM8801B | I <sub>F</sub> = 1.0 mA, V <sub>CE</sub> = 5 V<br>@ T <sub>A</sub> = 25°C   | 130  | 195  | 260  |      |
|                        |   |           | I <sub>F</sub> = 1.0 mA, V <sub>CE</sub> = 5 V                              | 65   | 195  | 360  |      |
|                        |   |           | I <sub>F</sub> = 1.6 mA, V <sub>CE</sub> = 5 V                              | 70   | 202  |      |      |
|                        |   |           | I <sub>F</sub> = 3.0 mA, V <sub>CE</sub> = 5 V                              | 75   | 215  |      |      |
|                        |   | FODM8801C | I <sub>F</sub> = 1.0 mA, V <sub>CE</sub> = 5 V<br>@ T <sub>A</sub> = 25°C   | 200  | 300  | 400  |      |
|                        |   |           | I <sub>F</sub> = 1.0 mA, V <sub>CE</sub> = 5 V                              | 100  | 300  | 560  |      |
|                        |   |           | I <sub>F</sub> = 1.6 mA, V <sub>CE</sub> = 5 V                              | 110  | 312  |      |      |
|                        |   |           | I <sub>F</sub> = 3.0 mA, V <sub>CE</sub> = 5 V                              | 115  | 330  |      |      |
| CTR <sub>CE(SAT)</sub> | Saturated Current Transfer Ratio<br>(Collector-Emitter) | FODM8801A | I <sub>F</sub> = 1.0 mA, V <sub>CE</sub> = 0.4 V<br>@ T <sub>A</sub> = 25°C | 65   | 108  | 150  | %    |
|                        |   |           | I <sub>F</sub> = 1.0 mA, V <sub>CE</sub> = 0.4 V                            | 30   | 108  |      |      |
|                        |   |           | I <sub>F</sub> = 1.6 mA, V <sub>CE</sub> = 0.4 V                            | 25   | 104  |      |      |
|                        |   |           | I <sub>F</sub> = 3.0 mA, V <sub>CE</sub> = 0.4 V                            | 20   | 92   |      |      |
|                        |   | FODM8801B | I <sub>F</sub> = 1.0 mA, V <sub>CE</sub> = 0.4 V<br>@ T <sub>A</sub> = 25°C | 90   | 168  | 245  |      |
|                        |   |           | I <sub>F</sub> = 1.0 mA, V <sub>CE</sub> = 0.4 V                            | 45   | 168  |      |      |
|                        |   |           | I <sub>F</sub> = 1.6 mA, V <sub>CE</sub> = 0.4 V                            | 40   | 155  |      |      |
|                        |   |           | I <sub>F</sub> = 3.0 mA, V <sub>CE</sub> = 0.4 V                            | 35   | 132  |      |      |
|                        |   | FODM8801C | I <sub>F</sub> = 1.0 mA, V <sub>CE</sub> = 0.4 V<br>@ T <sub>A</sub> = 25°C | 140  | 238  | 380  |      |
|                        |   |           | I <sub>F</sub> = 1.0 mA, V <sub>CE</sub> = 0.4 V                            | 75   | 238  |      |      |
|                        |   |           | I <sub>F</sub> = 1.6 mA, V <sub>CE</sub> = 0.4 V                            | 65   | 215  |      |      |
|                        |   |           | I <sub>F</sub> = 3.0 mA, V <sub>CE</sub> = 0.4 V                            | 55   | 177  |      |      |
| V <sub>CE(SAT)</sub>   | Saturation Voltage                                      | FODM8801A | I <sub>F</sub> = 1.0 mA, I <sub>C</sub> = 0.3 mA                            |      | 0.17 | 0.40 | V    |
|                        |   |           | I <sub>F</sub> = 1.6 mA, I <sub>C</sub> = 0.4 mA                            |      | 0.16 | 0.40 |      |
|                        |   |           | I <sub>F</sub> = 3.0 mA, I <sub>C</sub> = 0.6 mA                            |      | 0.15 | 0.40 |      |
|                        |   | FODM8801B | I <sub>F</sub> = 1.0 mA, I <sub>C</sub> = 0.45 mA                           |      | 0.17 | 0.40 |      |
|                        |   |           | I <sub>F</sub> = 1.6 mA, I <sub>C</sub> = 0.6 mA                            |      | 0.16 | 0.40 |      |
|                        |   |           | I <sub>F</sub> = 3.0 mA, I <sub>C</sub> = 1.0 mA                            |      | 0.16 | 0.40 |      |
|                        |   | FODM8801C | I <sub>F</sub> = 1.0 mA, I <sub>C</sub> = 0.75 mA                           |      | 0.18 | 0.40 |      |
|                        |   |           | I <sub>F</sub> = 1.6 mA, I <sub>C</sub> = 1.0 mA                            |      | 0.17 | 0.40 |      |
|                        |   |           | I <sub>F</sub> = 3.0 mA, I <sub>C</sub> = 1.6 mA                            |      | 0.17 | 0.40 |      |

## Switching Characteristics

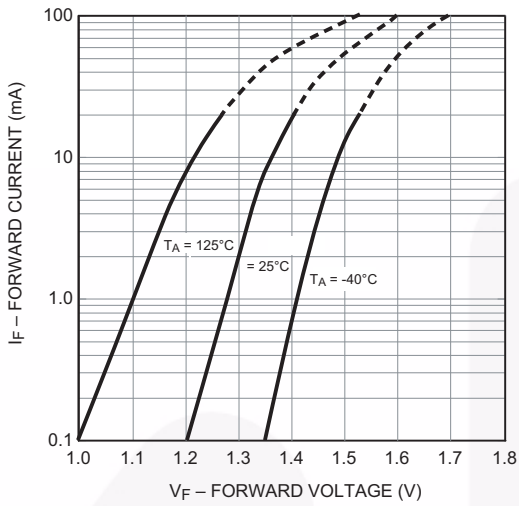
Apply over all recommended conditions ( $T_A = -40^\circ\text{C}$  to  $+125^\circ\text{C}$  unless otherwise specified).  
All typical values are measured at  $T_A = 25^\circ\text{C}$ .

| Symbol           | Parameter   | Device      | Conditions  | Min. | Typ. | Max. | Unit                      |
|------------------|---|-------------|---|------|------|------|---------------------------|
| $t_{\text{ON}}$  | Turn-On Time  | All Devices | $I_F = 1.6 \text{ mA}$ , $V_{\text{CC}} = 5 \text{ V}$ ,<br>$R_L = 0.75 \text{ k}\Omega$  | 1    | 6    | 20   | $\mu\text{s}$             |
|                  |   |             | $I_F = 1.6 \text{ mA}$ , $V_{\text{CC}} = 5 \text{ V}$ ,<br>$R_L = 4.7 \text{ k}\Omega$   |      | 6    |      |                           |
| $t_{\text{OFF}}$ | Turn-Off Time   | All Devices | $I_F = 1.6 \text{ mA}$ , $V_{\text{CC}} = 5 \text{ V}$ ,<br>$R_L = 0.75 \text{ k}\Omega$  | 1    | 6    | 20   | $\mu\text{s}$             |
|                  |   |             | $I_F = 1.6 \text{ mA}$ , $V_{\text{CC}} = 5 \text{ V}$ ,<br>$R_L = 4.7 \text{ k}\Omega$   |      | 40   |      |                           |
| $t_R$            | Output Rise Time<br>(10% to 90%)  | All Devices | $I_F = 1.6 \text{ mA}$ , $V_{\text{CC}} = 5 \text{ V}$ ,<br>$R_L = 0.75 \text{ k}\Omega$  |      | 5    |      | $\mu\text{s}$             |
| $t_F$            | Output Fall Time<br>(90% to 10%)  | All Devices | $I_F = 1.6 \text{ mA}$ , $V_{\text{CC}} = 5 \text{ V}$ ,<br>$R_L = 0.75 \text{ k}\Omega$  |      | 5.5  |      | $\mu\text{s}$             |
| $\text{CM}_H$    | Common-Mode<br>Rejection Voltage<br>(Transient Immunity) –<br>Output High | All Devices | $T_A = 25^\circ\text{C}$ , $I_F = 0 \text{ mA}$ ,<br>$V_O > 2.0 \text{ V}$ , $R_L = 4.7 \text{ k}\Omega$ ,<br>$V_{\text{CM}} = 1000 \text{ V}^{(7)}$ ,<br>Figure 16   |      | 20   |      | $\text{kV} / \mu\text{s}$ |
| $\text{CM}_L$    | Common-Mode<br>Rejection Voltage<br>(Transient Immunity) –<br>Output Low  | All Devices | $T_A = 25^\circ\text{C}$ , $I_F = 1.6 \text{ mA}$ ,<br>$V_O < 0.8 \text{ V}$ , $R_L = 4.7 \text{ k}\Omega$ ,<br>$V_{\text{CM}} = 1000 \text{ V}^{(7)}$ ,<br>Figure 16 |      | 20   |      | $\text{kV} / \mu\text{s}$ |

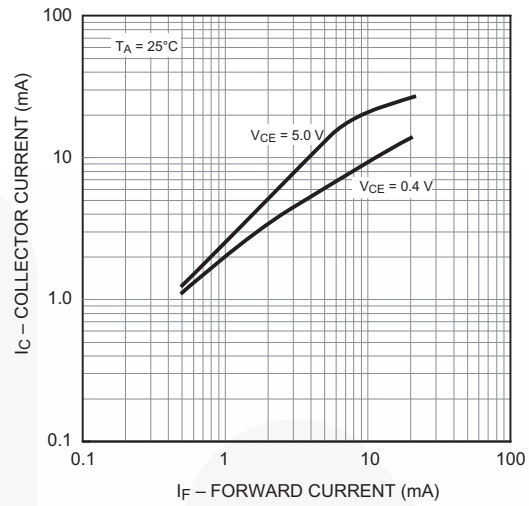
### Note:

7. Common-mode transient immunity at output high is the maximum tolerable positive  $dV_{\text{CM}}/dt$  on the leading edge of the common-mode impulse signal,  $V_{\text{CM}}$ , to assure that the output remains high.

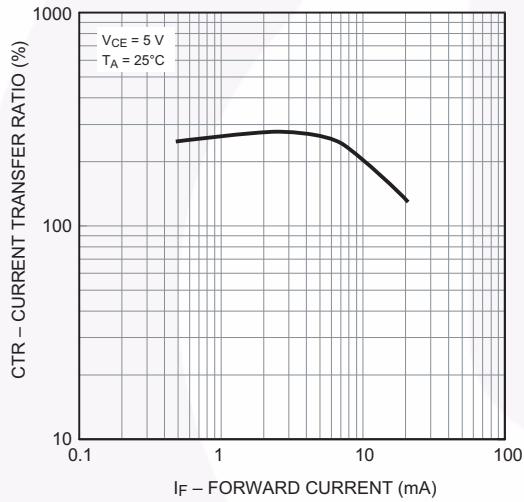
### Typical Performance Curves



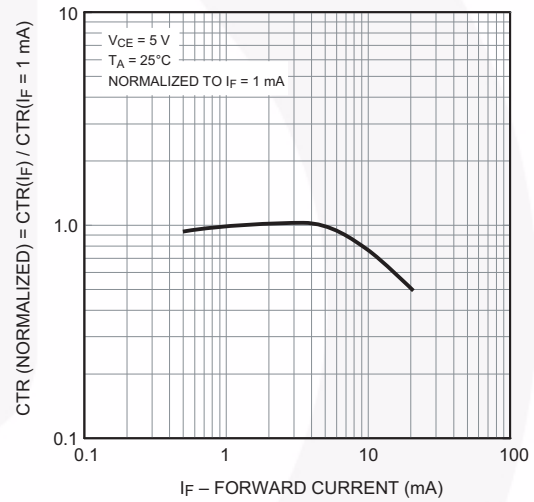
**Figure 3. Forward Current vs. Forward Voltage**



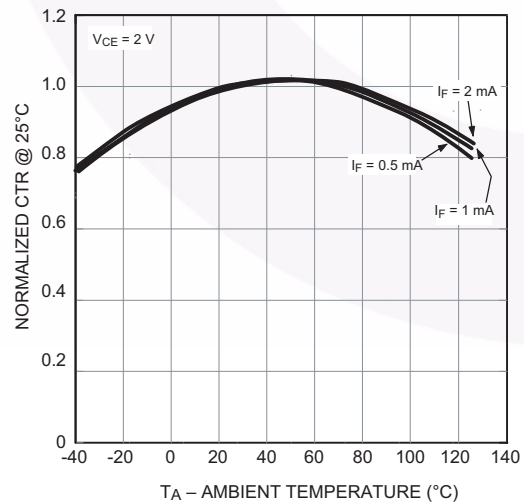
**Figure 4. Collector Current vs. Forward Current**



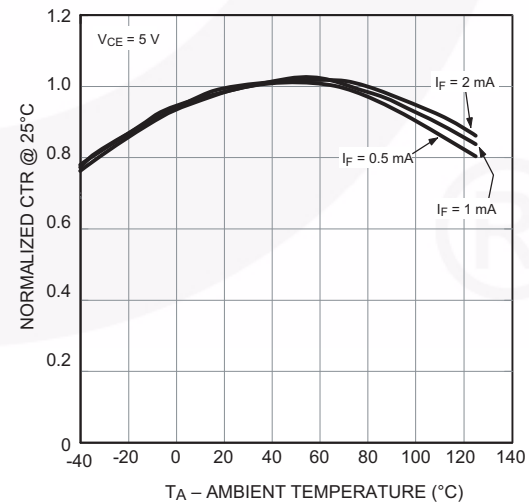
**Figure 5. Current Transfer Ratio vs. Forward Current**



**Figure 6. Normalized CTR vs. Forward Current**



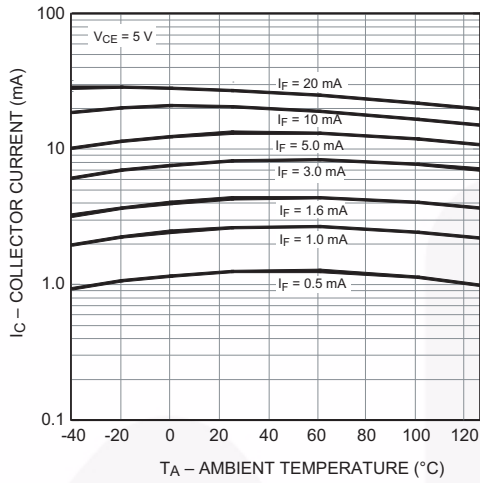
**Figure 7. Normalized CTR vs. Ambient Temperature**



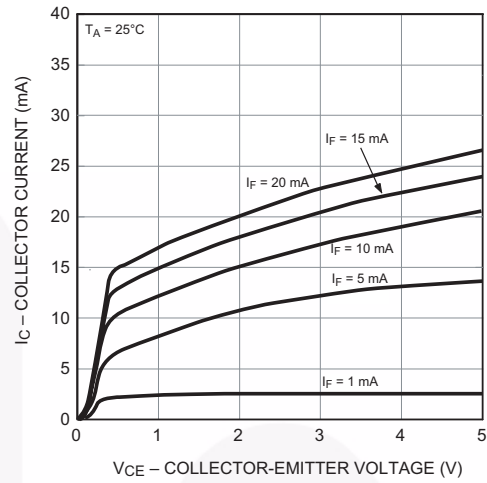
**Figure 8. Normalized CTR vs. Ambient Temperature**



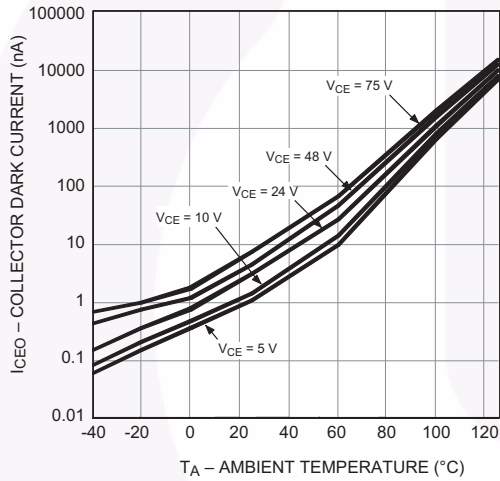
**Typical Performance Curves (Continued)**



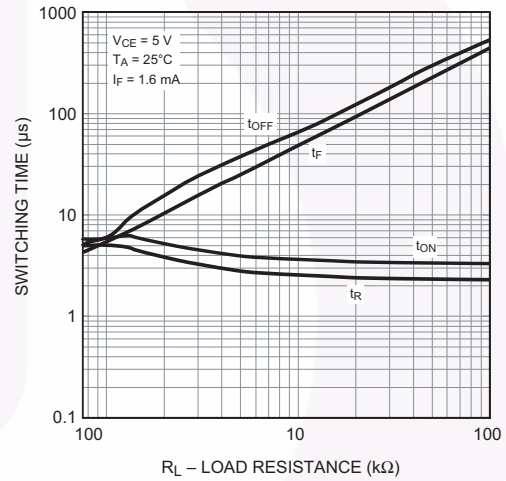
**Figure 9. Collector Current vs. Ambient Temperature**



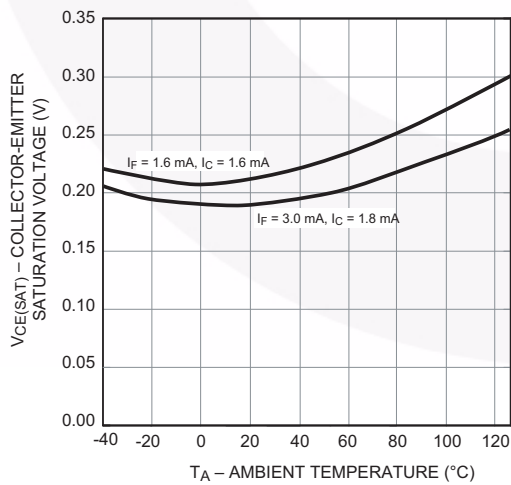
**Figure 10 Collector Current vs. Collector-Emitter Voltage**



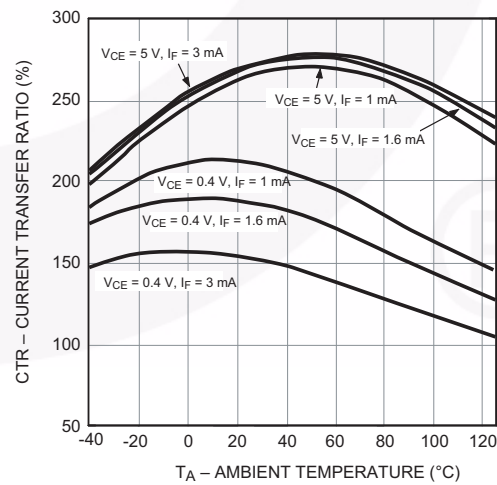
**Figure 11. Collector Dark Current vs. Ambient Temperature**



**Figure 12. Switching Time vs. Load Resistance**

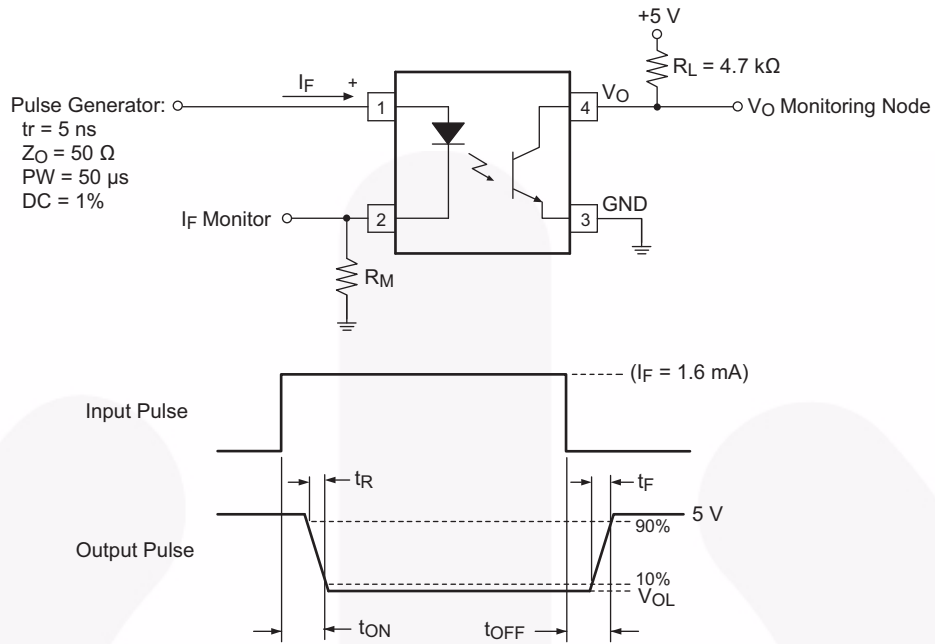


**Figure 13. Collector-Emitter Saturation Voltage vs. Ambient Temperature**

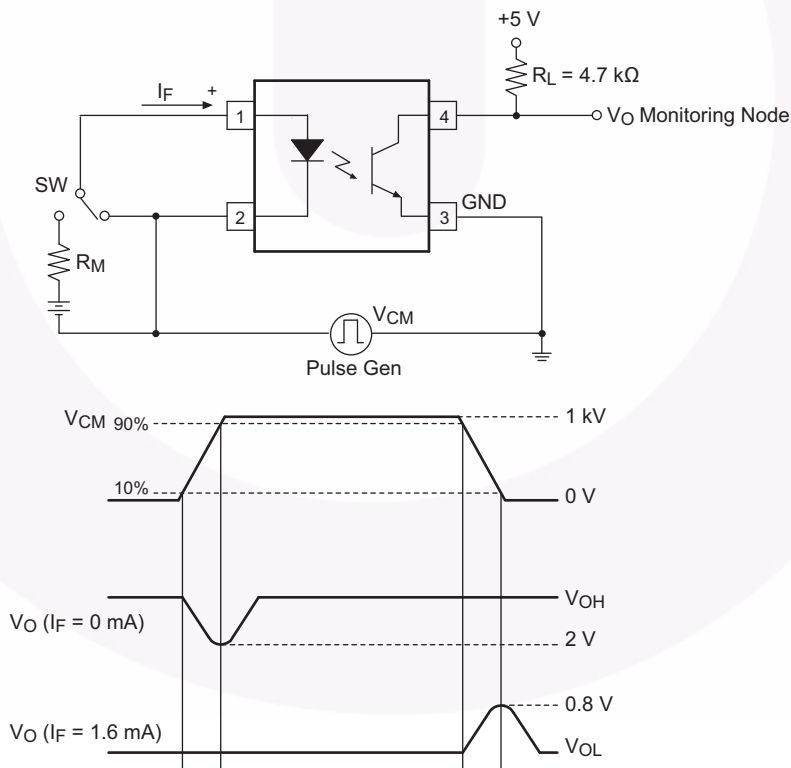


**Figure 14. Current Transfer Ratio vs. Ambient Temperature**

### Test Circuits



**Figure 15. Test Circuit for Propagation Delay, Rise Time, and Fall Time**



**Figure 16. Test Circuit for Instantaneous Common-Mode Rejection Voltage**

## Reflow Profile

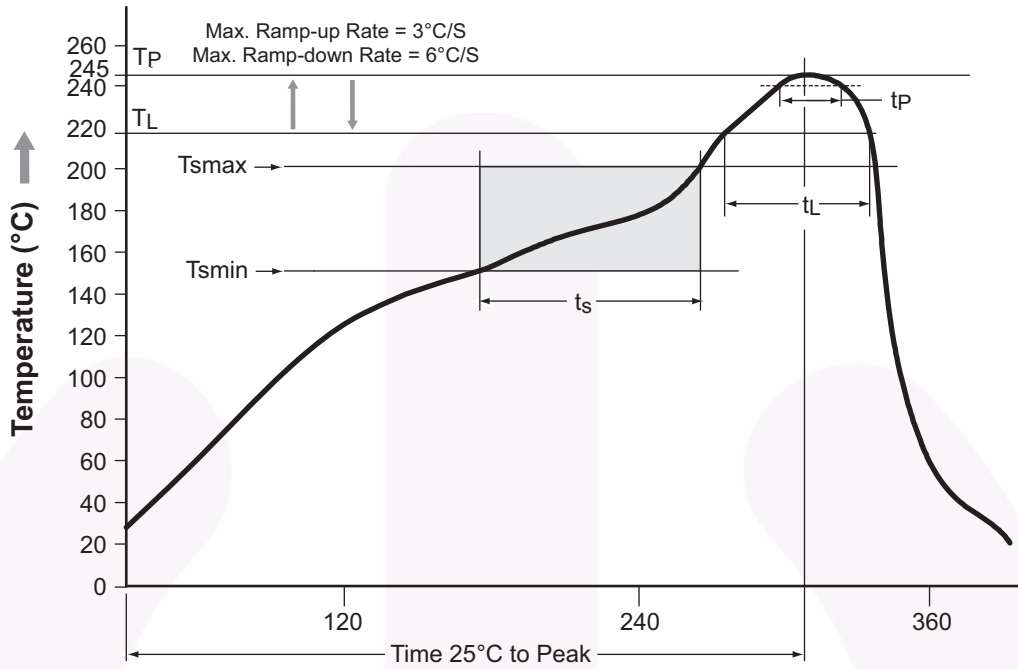


Figure 13. Reflow Profile

| Profile Feature   | Pb-Free Assembly Profile |
|---|--------------------------|
| Temperature Minimum (T <sub>smin</sub> )                              | 150°C                    |
| Temperature Maximum (T <sub>smax</sub> )                              | 200°C                    |
| Time (t <sub>s</sub> ) from (T <sub>smin</sub> to T <sub>smax</sub> ) | 60–120 seconds           |
| Ramp-up Rate (t <sub>L</sub> to t <sub>P</sub> )                      | 3°C/second maximum       |
| Liquidous Temperature (T <sub>L</sub> )                               | 217°C                    |
| Time (t <sub>L</sub> ) Maintained Above (T <sub>L</sub> )             | 60–150 seconds           |
| Peak Body Package Temperature   | 245°C +0°C / –5°C        |
| Time (t <sub>P</sub> ) within 5°C of 245°C                            | 30 seconds               |
| Ramp-down Rate (T <sub>P</sub> to T <sub>L</sub> )                    | 6°C/second maximum       |
| Time 25°C to Peak Temperature   | 8 minutes maximum        |

Figure 17. Reflow Profile

## Ordering Information

| Part Number  | Package  | Packing Method             |
|--------------|--|----------------------------|
| FODM8801A    | Half Pitch Mini-Flat 4-Pin                             | Tube (100 units)           |
| FODM8801AR2  | Half Pitch Mini-Flat 4-Pin                             | Tape and Reel (2500 Units) |
| FODM8801AV   | Half Pitch Mini-Flat 4-Pin, DIN EN/IEC60747-5-5 Option | Tube (100 Units)           |
| FODM8801AR2V | Half Pitch Mini-Flat 4-Pin, DIN EN/IEC60747-5-5 Option | Tape and Reel (2500 Units) |

**Note:**

8. The product orderable part number system listed in this table also applies to the FODM8801B, FODM8801C products.

## Marking Information

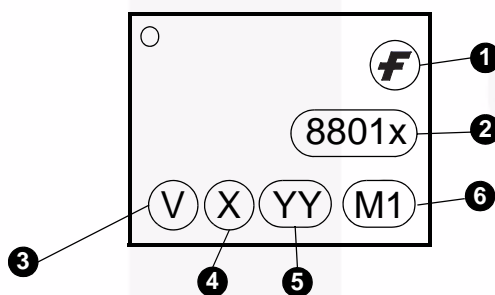
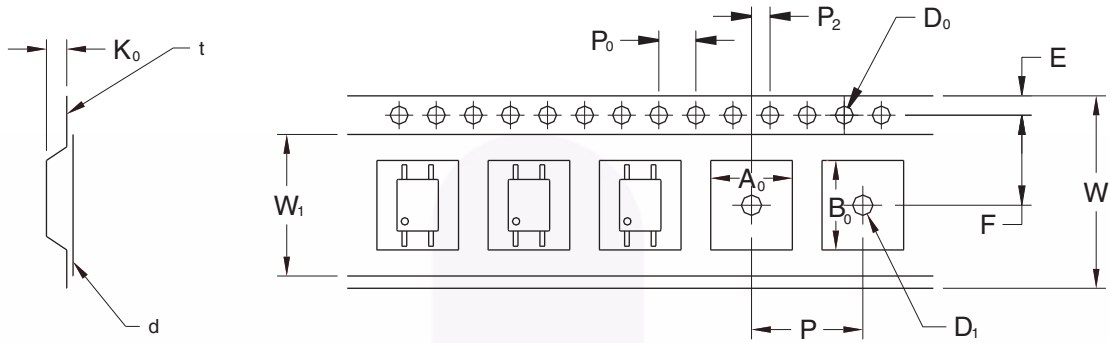


Figure 18. Top Mark

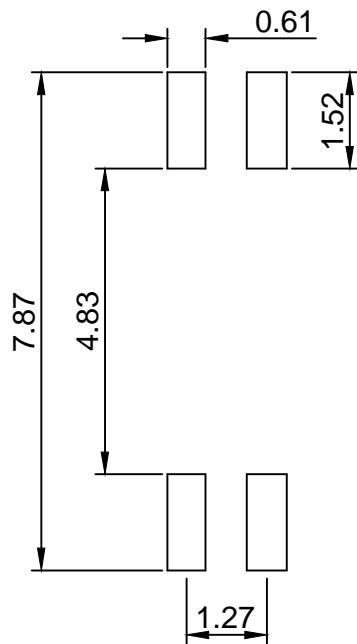
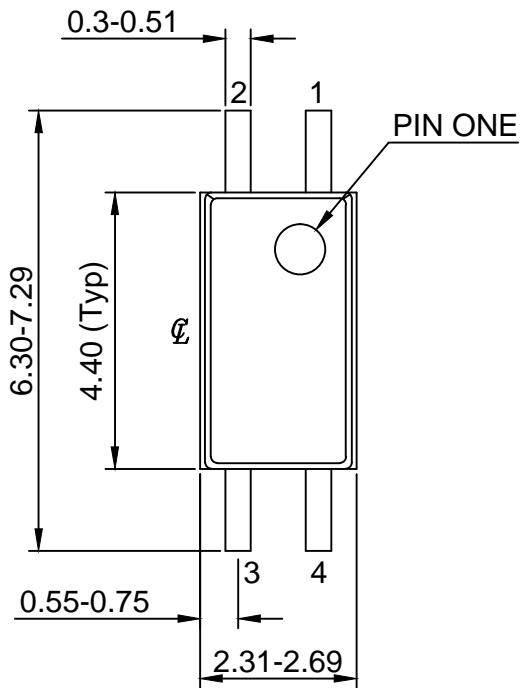
Table 1. Top Mark Definitions

|   |   |
|---|---|
| 1 | Fairchild Logo  |
| 2 | Device Number   |
| 3 | DIN EN/IEC60747-5-5 Option (only appears on component ordered with this option) |
| 4 | One-Digit Year Code, e.g., "6"  |
| 5 | Digit Work Week, Ranging from "01" to "53"                                      |
| 6 | Assembly Package Code   |

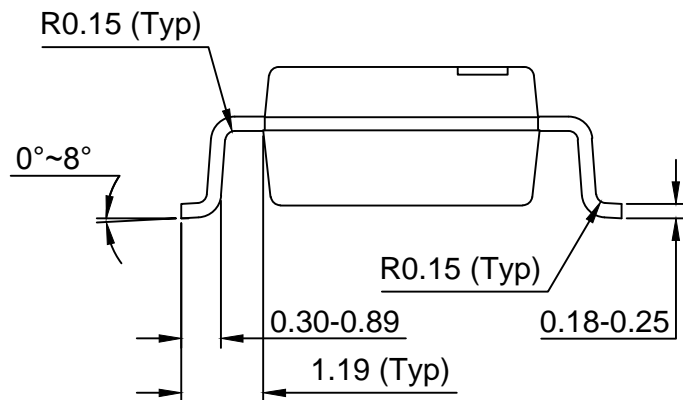
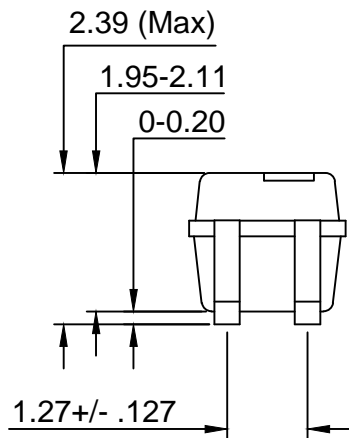
## Tape and Reel Dimensions



|                                 |                | 1.27 Pitch        |
|---------------------------------|----------------|-------------------|
| Description                     | Symbol         | Dimensions (mm)   |
| Tape Width                      | W              | 12.00 +0.30/-0.10 |
| Tape Thickness                  | t              | 0.30 ±0.05        |
| Sprocket Hole Pitch             | P <sub>0</sub> | 4.00 ±0.10        |
| Sprocket Hole Diameter          | D <sub>0</sub> | 1.50 +0.10/-0.0   |
| Sprocket Hole Location          | E              | 1.75 ±0.10        |
| Pocket Location                 | F              | 5.50 ±0.10        |
|                                 | P <sub>2</sub> | 2.00 ±0.10        |
| Pocket Pitch                    | P              | 8.00 ±0.10        |
| Pocket Dimension                | A <sub>0</sub> | 2.80 ±0.10        |
|                                 | B <sub>0</sub> | 7.30 ±0.10        |
|                                 | K <sub>0</sub> | 2.30 ±0.10        |
| Pocket Hole Diameter            | D <sub>1</sub> | 1.50 Min.         |
| Cover Tape Width                | W <sub>1</sub> | 9.20              |
| Cover Tape Thickness            | d              | 0.065 ±0.010      |
| Max. Component Rotation or Tilt |                | 10° Max.          |
| Devices Per Reel                |                | 2500              |
| Reel Diameter                   |                | 330 mm (13")      |



LAND PATTERN RECOMMENDATION



NOTES:

- A) NO STANDARD APPLIES TO THIS PACKAGE
- B) ALL DIMENSIONS ARE IN MILLIMETERS.
- C) DIMENSIONS ARE EXCLUSIVE OF BURRS, MOLD FLASH, AND TIE BAR EXTRUSION
- D) DRAWING FILENAME AND REVISION : MKT-MFP04AREV4.



ON Semiconductor and  are trademarks of Semiconductor Components Industries, LLC dba ON Semiconductor or its subsidiaries in the United States and/or other countries. ON Semiconductor owns the rights to a number of patents, trademarks, copyrights, trade secrets, and other intellectual property. A listing of ON Semiconductor's product/patent coverage may be accessed at [www.onsemi.com/site/pdf/Patent-Marking.pdf](http://www.onsemi.com/site/pdf/Patent-Marking.pdf). ON Semiconductor reserves the right to make changes without further notice to any products herein. ON Semiconductor makes no warranty, representation or guarantee regarding the suitability of its products for any particular purpose, nor does ON Semiconductor assume any liability arising out of the application or use of any product or circuit, and specifically disclaims any and all liability, including without limitation special, consequential or incidental damages. Buyer is responsible for its products and applications using ON Semiconductor products, including compliance with all laws, regulations and safety requirements or standards, regardless of any support or applications information provided by ON Semiconductor. "Typical" parameters which may be provided in ON Semiconductor data sheets and/or specifications can and do vary in different applications and actual performance may vary over time. All operating parameters, including "Typicals" must be validated for each customer application by customer's technical experts. ON Semiconductor does not convey any license under its patent rights nor the rights of others. ON Semiconductor products are not designed, intended, or authorized for use as a critical component in life support systems or any FDA Class 3 medical devices or medical devices with a same or similar classification in a foreign jurisdiction or any devices intended for implantation in the human body. Should Buyer purchase or use ON Semiconductor products for any such unintended or unauthorized application, Buyer shall indemnify and hold ON Semiconductor and its officers, employees, subsidiaries, affiliates, and distributors harmless against all claims, costs, damages, and expenses, and reasonable attorney fees arising out of, directly or indirectly, any claim of personal injury or death associated with such unintended or unauthorized use, even if such claim alleges that ON Semiconductor was negligent regarding the design or manufacture of the part. ON Semiconductor is an Equal Opportunity/Affirmative Action Employer. This literature is subject to all applicable copyright laws and is not for resale in any manner.

## PUBLICATION ORDERING INFORMATION

### LITERATURE FULFILLMENT:

Literature Distribution Center for ON Semiconductor  
19521 E. 32nd Pkwy, Aurora, Colorado 80011 USA  
**Phone:** 303-675-2175 or 800-344-3860 Toll Free USA/Canada  
**Fax:** 303-675-2176 or 800-344-3867 Toll Free USA/Canada  
**Email:** [orderlit@onsemi.com](mailto:orderlit@onsemi.com)

**N. American Technical Support:** 800-282-9855 Toll Free  
USA/Canada  
**Europe, Middle East and Africa Technical Support:**  
Phone: 421 33 790 2910  
**Japan Customer Focus Center**  
Phone: 81-3-5817-1050

**ON Semiconductor Website:** [www.onsemi.com](http://www.onsemi.com)  
**Order Literature:** <http://www.onsemi.com/orderlit>  
For additional information, please contact your local  
Sales Representative