



Is Now Part of



**ON Semiconductor®**

To learn more about ON Semiconductor, please visit our website at

[www.onsemi.com](http://www.onsemi.com)

ON Semiconductor and the ON Semiconductor logo are trademarks of Semiconductor Components Industries, LLC dba ON Semiconductor or its subsidiaries in the United States and/or other countries. ON Semiconductor owns the rights to a number of patents, trademarks, copyrights, trade secrets, and other intellectual property. A listing of ON Semiconductor's product/patent coverage may be accessed at [www.onsemi.com/site/pdf/Patent-Marking.pdf](http://www.onsemi.com/site/pdf/Patent-Marking.pdf). ON Semiconductor reserves the right to make changes without further notice to any products herein. ON Semiconductor makes no warranty, representation or guarantee regarding the suitability of its products for any particular purpose, nor does ON Semiconductor assume any liability arising out of the application or use of any product or circuit, and specifically disclaims any and all liability, including without limitation special, consequential or incidental damages. Buyer is responsible for its products and applications using ON Semiconductor products, including compliance with all laws, regulations and safety requirements or standards, regardless of any support or applications information provided by ON Semiconductor. "Typical" parameters which may be provided in ON Semiconductor data sheets and/or specifications can and do vary in different applications and actual performance may vary over time. All operating parameters, including "Typicals" must be validated for each customer application by customer's technical experts. ON Semiconductor does not convey any license under its patent rights nor the rights of others. ON Semiconductor products are not designed, intended, or authorized for use as a critical component in life support systems or any FDA Class 3 medical devices or medical devices with a same or similar classification in a foreign jurisdiction or any devices intended for implantation in the human body. Should Buyer purchase or use ON Semiconductor products for any such unintended or unauthorized application, Buyer shall indemnify and hold ON Semiconductor and its officers, employees, subsidiaries, affiliates, and distributors harmless against all claims, costs, damages, and expenses, and reasonable attorney fees arising out of, directly or indirectly, any claim of personal injury or death associated with such unintended or unauthorized use, even if such claim alleges that ON Semiconductor was negligent regarding the design or manufacture of the part. ON Semiconductor is an Equal Opportunity/Affirmative Action Employer. This literature is subject to all applicable copyright laws and is not for resale in any manner.

## FIN1028 — 3.3V LVDS 2-Bit High-Speed Differential Receiver

### Features


- Greater than 400Mbps Data Rate
- Power Supply Operation: 3.3V
- Maximum Differential Pulse Skew: 0.4ns
- Maximum Propagation Delay: 2.5ns
- Low-Power Dissipation
- Power-Off Protection
- Fail-Safe Protection for Open-Circuit, Shorted, and Terminated Conditions
- Meets or Exceeds the TIA/EIA-644 LVDS Standard
- Flow-through Pinout Simplifies PCB Layout

### Description

This dual receiver is designed for high-speed interconnects utilizing Low Voltage Differential Signaling (LVDS) technology. The receiver translates LVDS levels, with a typical differential input threshold of 100mV, to LVTTTL signal levels. LVDS provides low EMI at ultra-low power dissipation, even at high frequencies. This device is ideal for high-speed transfer of clock and data signals.

The FIN1028 can be paired with its companion driver, the FIN1027, or any other LVDS driver.

### Ordering Information

Part Number	Operating Temperature Range	 Eco Status	Package	Packing Method
FIN1028M	-40 to +85°C	RoHS	8-Lead Small Outline Package (SOIC) JEDEC MS-012, 0.150 inch Narrow	Trays
FIN1028MX	-40 to +85°C	RoHS	8-Lead Small Outline Package (SOIC) JEDEC MS-012, 0.150 inch Narrow	Tape and Reel

 For Fairchild's definition of "green" Eco Status, please visit: [http://www.fairchildsemi.com/company/green/rohs\\_green.html](http://www.fairchildsemi.com/company/green/rohs_green.html).

## Pin Configuration

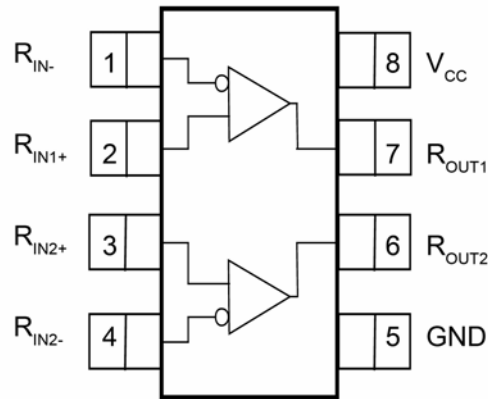


Figure 1. SOIC Pin Assignments (Top View)

## Pin Definitions

Pin #	Name	Description
1	R <sub>IN1-</sub>	Inverting LVDS Input
2	R <sub>IN1+</sub>	Non-Inverting LVDS Input
3	R <sub>IN2+</sub>	Non-Inverting LVDS Input
4	R <sub>IN2-</sub>	Inverting LVDS Input
5	GND	Ground
6	R <sub>OUT2</sub>	LVTTTL Data Output
7	R <sub>OUT1</sub>	LVTTTL Data Output
8	V <sub>CC</sub>	Power Supply

## Function Table

Inputs		Outputs
R <sub>IN+</sub>	R <sub>IN-</sub>	R <sub>out</sub>
LOW	HIGH	LOW
HIGH	LOW	HIGH
Fail-Safe Conditions <sup>(1)</sup>		HIGH

**Note:**

1. Fail-safe=open, shorted, terminated.

## Absolute Maximum Ratings

Stresses exceeding the absolute maximum ratings may damage the device. The device may not function or be operable above the recommended operating conditions and stressing the parts to these levels is not recommended. In addition, extended exposure to stresses above the recommended operating conditions may affect device reliability. The absolute maximum ratings are stress ratings only.

Symbol	Parameter	Min.	Max.	Unit
$V_{CC}$	Supply Voltage	-0.5	4.6	V
$R_{INx+}, R_{INx-}$	DC Input Voltage	-0.5	4.7	V
$R_{OUTx}$	DC Output Voltage	-0.5	6.0	V
$I_O$	DC Output Current		16	mA
$T_{STG}$	Storage Temperature Range	-65	+150	°C
$T_J$	Maximum Junction Temperature		+150	°C
$T_L$	Lead Temperature, Soldering 10 Seconds		+260	°C
ESD	Human Body Model, JESD22-A114		≥6500	V
	Machine Model, JESD22-A115		≥300	

## Recommended Operating Conditions

The Recommended Operating Conditions table defines the conditions for actual device operation. Recommended operating conditions are specified to ensure optimal performance to the datasheet specifications. Fairchild does not recommend exceeding them or designing to Absolute Maximum Ratings.

Symbol	Parameter	Min.	Max.	Unit
$V_{CC}$	Supply Voltage	3.0	3.6	V
$V_{IN}$	Input Voltage	0	$V_{CC}$	V
$ V_{ID} $	Magnitude of Differential Voltage	100	$V_{CC}$	mV
$V_{IC}$	Common-Mode Input Voltage	0.05	2.35	V
$T_A$	Operating Temperature	-40	+85	°C

## DC Electrical Characteristics

Typical values are at  $T_A=25^\circ\text{C}$  and with  $V_{CC}=3.3\text{V}$ . Over-supply voltage and operating temperature ranges, unless otherwise noted.

Symbol	Parameter	Conditions	Min.	Typ.	Max.	Units
$V_{TH}$	Differential Input Threshold HIGH	Figure 2, Table 1			100	mV
$V_{TL}$	Differential Input Threshold LOW	Figure 2, Table 1	-100			mV
$I_{IN}$	Input Current	$V_{IN}=0\text{V}$ or $V_{CC}$			$\pm 20$	$\mu\text{A}$
$I_{I(OFF)}$	Power-off Input Current	$V_{CC}=0\text{V}$ , $V_{IN}=0\text{V}$ or $3.6\text{V}$			$\pm 20$	$\mu\text{A}$
$V_{OH}$	Output HIGH Voltage	$I_{OH}=-100\mu\text{A}$	$V_{CC}-0.2$			V
		$I_{OH}=-8\text{mA}$	2.4			
$V_{OL}$	Output LOW Voltage	$I_{OL}=100\mu\text{A}$			0.2	V
		$I_{OL}=8\text{mA}$			0.5	
$V_{IK}$	Input Clamp Voltage	$I_{IK}=-18\text{mA}$	-1.5			V
$I_{CC}$	Power Supply Current	$R_{IN+}=1\text{V}$ and $R_{IN-}=1.4\text{V}$ or $R_{IN+}=1.4\text{V}$ and $R_{IN-}=1\text{V}$			9	mA
$C_{IN}$	Input Capacitance			4		pF
$C_{OUT}$	Output Capacitance			6		pF

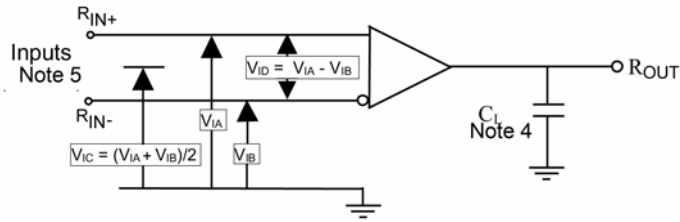
## DC Electrical Characteristics

Typical values are at  $T_A=25^\circ\text{C}$  and with  $V_{CC}=3.3\text{V}$ . Over-supply voltage and operating temperature ranges, unless otherwise noted.

Symbol	Parameter	Conditions	Min.	Typ.	Max.	Units
$t_{PLH}$	Differential Propagation Delay, LOW-to-HIGH	$ V_{ID} =400\text{mV}$ , $C_L=10\text{pF}$ Figure 2, Figure 3	0.9		2.5	ns
$t_{PHL}$	Differential Propagation Delay, HIGH-to-LOW		0.9		2.5	ns
$t_{TLH}$	Output Rise Time (20% to 80%)			0.5		ns
$t_{THL}$	Output Fall Time (80% to 20%)			0.5		ns
$t_{SK(P)}$	Pulse Skew $ t_{PLH} - t_{PHL} $				0.4	ns
$t_{SK(LH)}, t_{SK(HL)}$	Channel-to-Channel Skew <sup>(2)</sup>				0.3	ns
$t_{SK(PP)}$	Part-to-Part Skew <sup>(3)</sup>				1.0	ns

### Notes:

- $t_{SK(LH)}, t_{SK(HL)}$  is the skew between specified outputs of a single device when the outputs have identical loads and are switching in the same direction.
- $t_{SK(PP)}$  is the magnitude of the difference in propagation delay times between any specified terminals of two devices switching in the same direction (either LOW-to-HIGH or HIGH-to-LOW) when both devices operate with the same supply voltage, same temperature, and have identical test circuits.



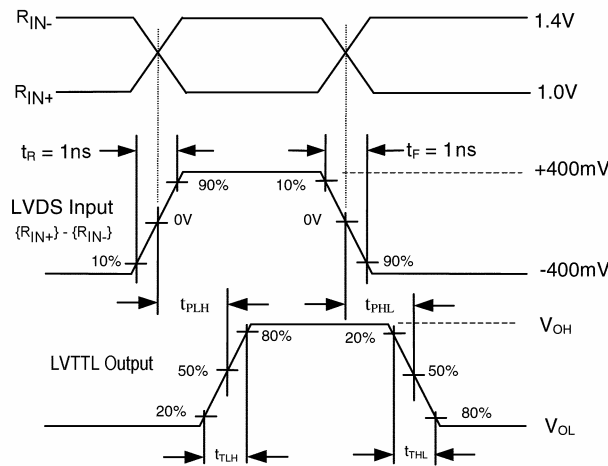
**Figure 2. Differential Driver Propagation Delay and Transition Time Test Circuit**

**Notes:**

- 4.  $C_L$  includes all probe and fixture capacitances.
- 5. All input pulses have frequency = 10MHz,  $t_R$  or  $t_F=1ns$ .

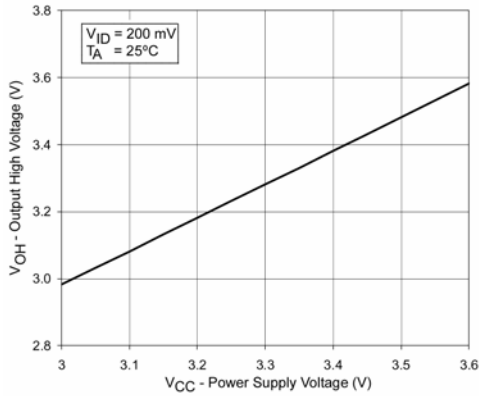
**Table 1. Receiver Minimum and Maximum Input Threshold Test Voltages**

Applied Voltages (V)		Resulting Differential Input Voltage (mV)	Resulting Common Mode Input Voltage (V)
$V_{IA}$	$V_{IB}$	$V_{ID}$	$V_{IC}$
1.25	1.15	100	1.2
1.15	1.25	-100	1.2
2.4	2.3	100	2.35
2.3	2.4	-100	2.35
0.1	0	100	0.05
0	0.1	-100	0.05
1.5	0.9	600	1.2
0.9	1.5	-600	1.2
2.4	1.8	600	2.1
1.8	2.4	-600	2.1
0.6	0	600	0.3
0	0.6	-600	0.3

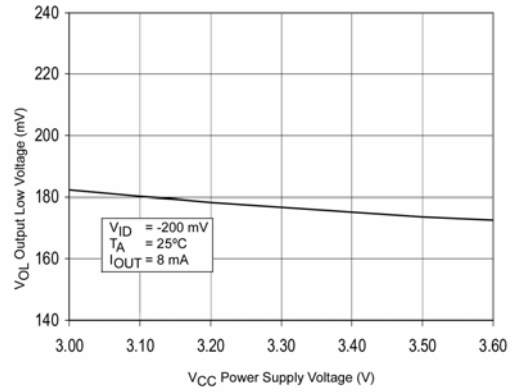


**Figure 3. AC Waveforms**

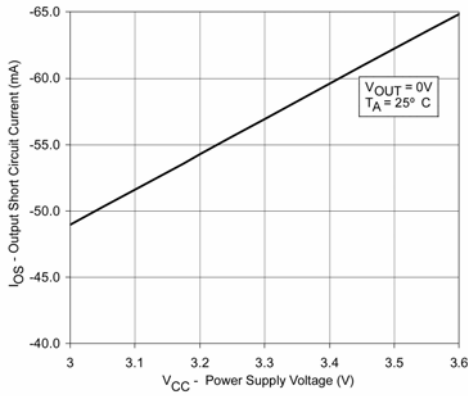
## Typical Performance Characteristics



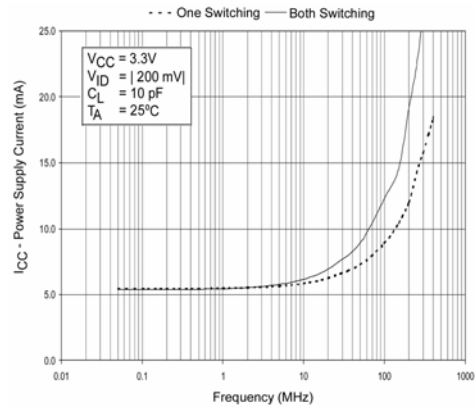
**Figure 4. Output High Voltage vs. Power Supply Voltage**



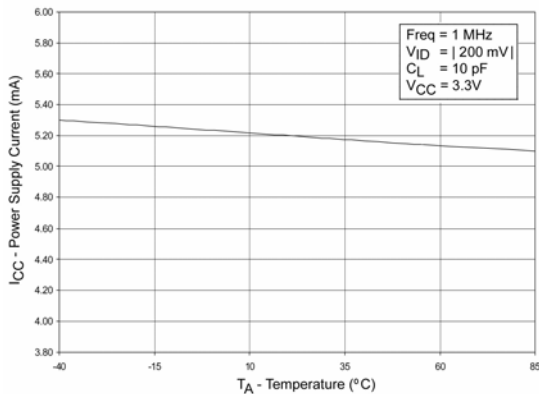
**Figure 5. Output Low Voltage vs. Power Supply Voltage**



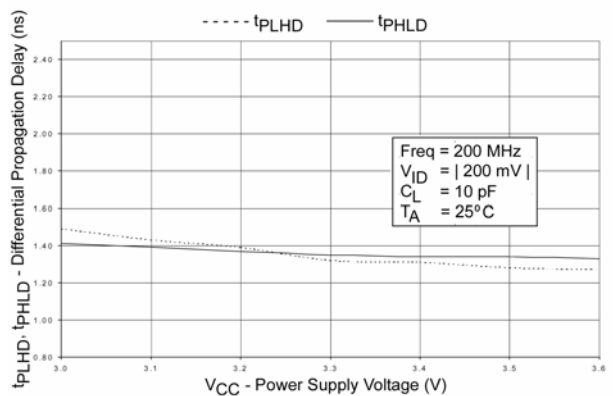
**Figure 6. Output Short Circuit Current vs. Power Supply Voltage**



**Figure 7. Power Supply Current vs. Frequency**

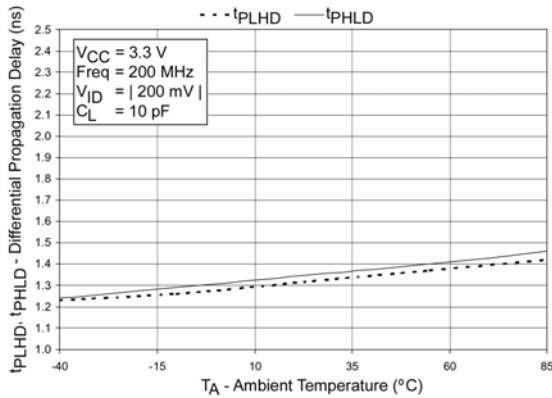


**Figure 8. Power Supply Current vs. Ambient Temperature**

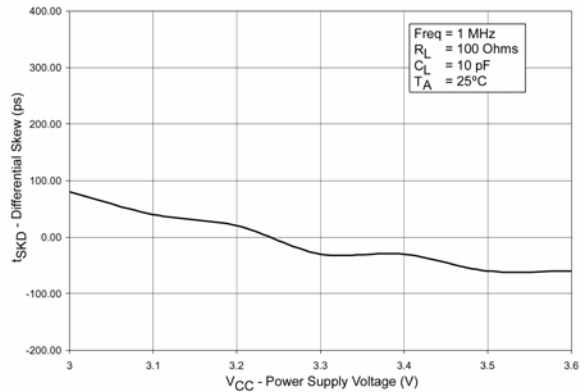


**Figure 9. Differential Propagation Delay vs. Power Supply Voltage**

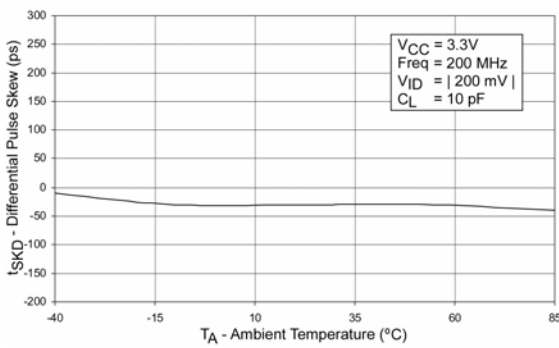
**Typical Performance Characteristics (Continued)**



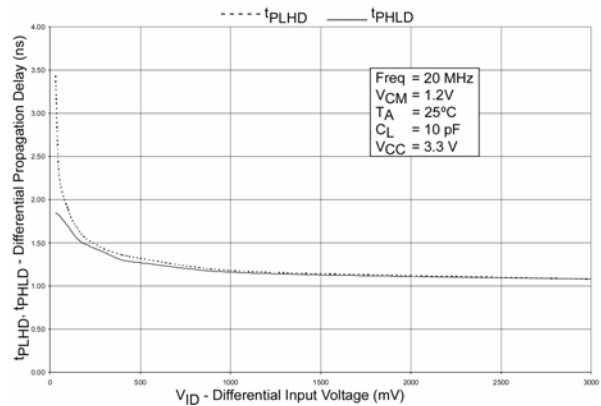
**Figure 10. Differential Propagation Delay vs. Ambient Temperature**



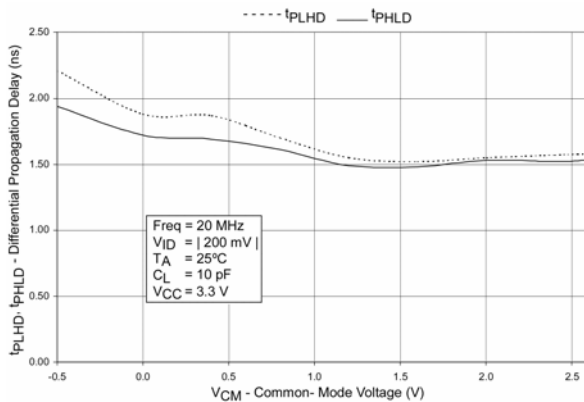
**Figure 11. Differential Skew ( $t_{PLH}-t_{PHL}$ ) vs. Power Supply Voltage**



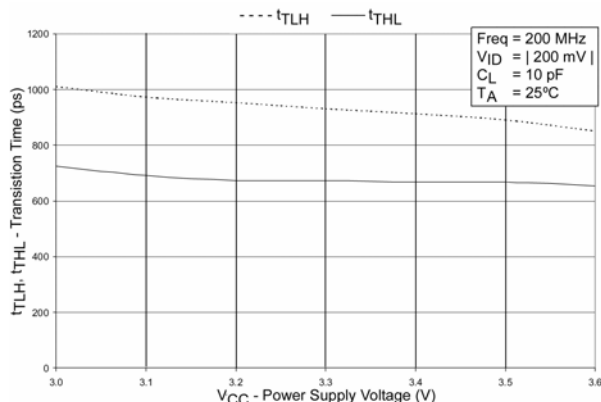
**Figure 12. Differential Skew ( $t_{PHL}-t_{PHL}$ ) vs. Ambient Temperature**



**Figure 13. Differential Propagation Delay vs. Differential Input Voltage**



**Figure 14. Differential Propagation Delay vs. Common-Mode Voltage**



**Figure 15. Transition Time vs. Power Supply Voltage**



## Typical Performance Characteristics (Continued)

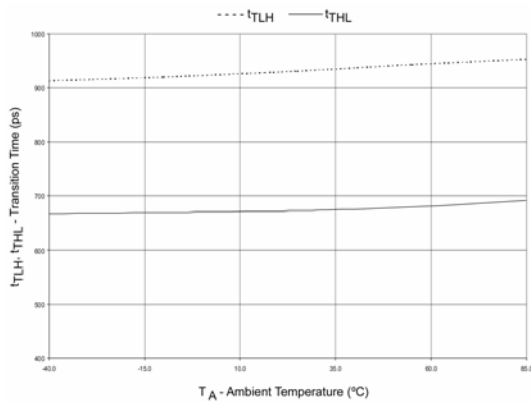


Figure 16. Transition Time vs. Ambient Temperature

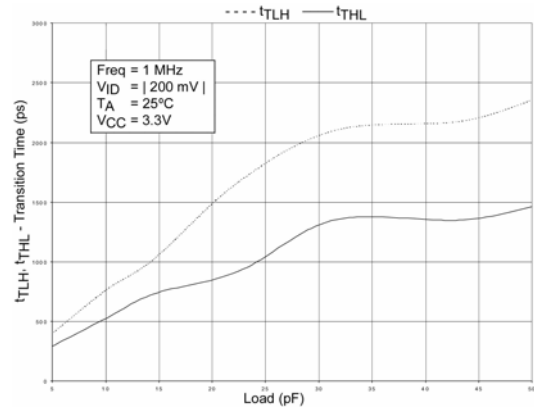


Figure 17. Differential Propagation Delay vs. Load

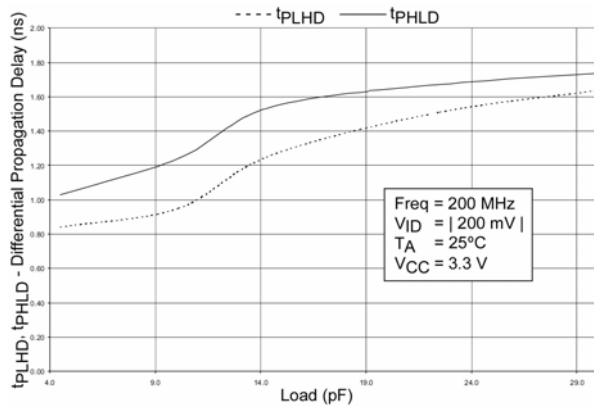


Figure 18. Differential Propagation Delay vs. Load

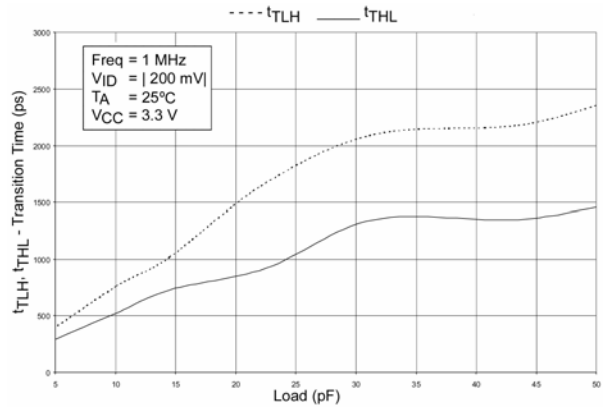


Figure 19. Transition Time vs. Load

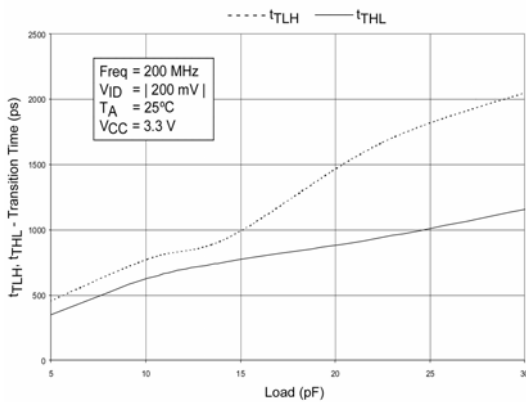


Figure 20. Transition Time vs. Load

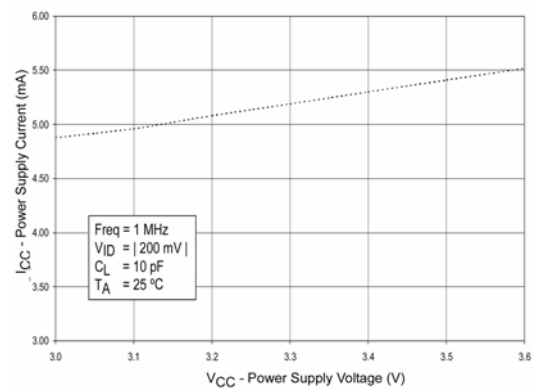


Figure 21. Power Supply Current vs. Power Supply Voltage

Physical Dimensions

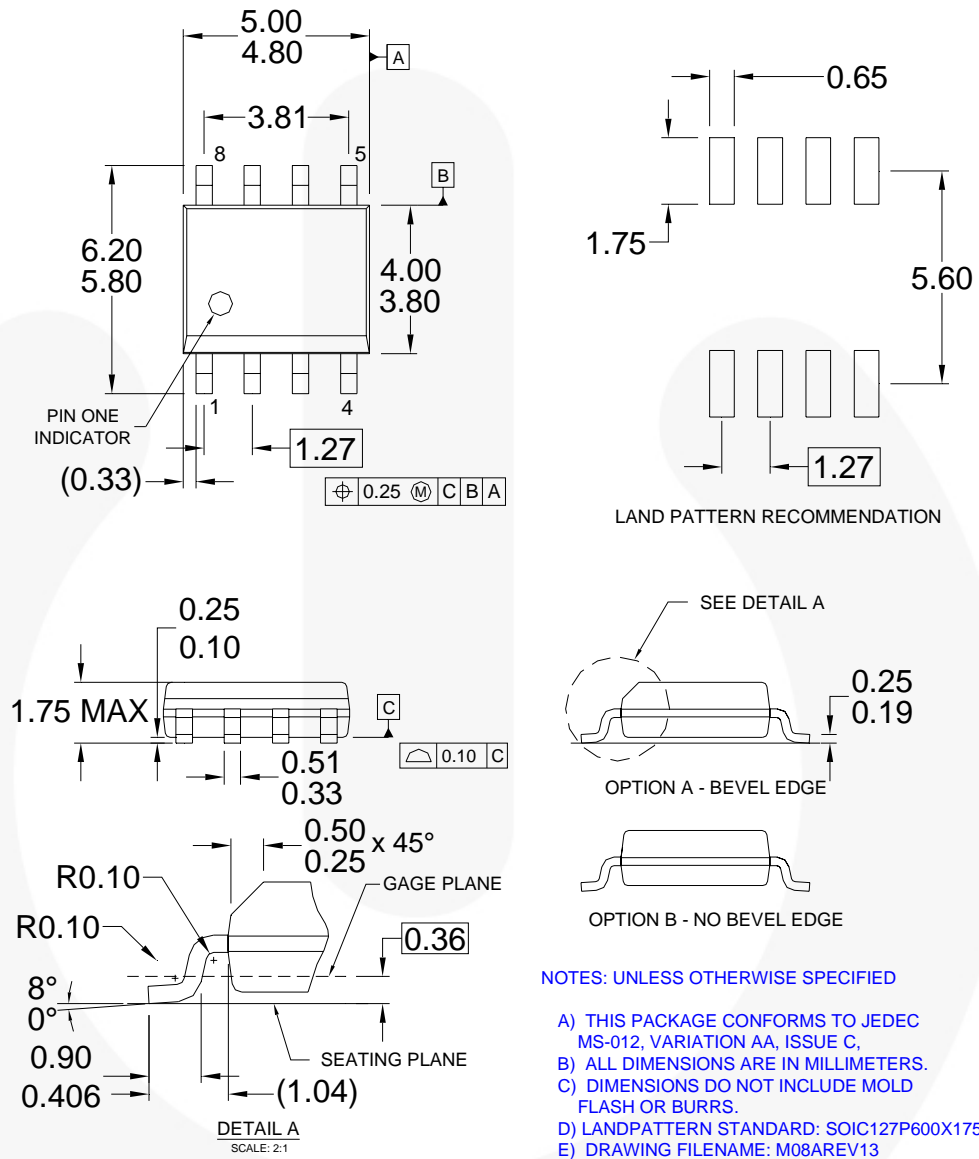


Figure 22. 8-Lead, Small Outline Package (SOIC), JEDEC MS-012, 0.150-inch, Narrow Body

[Click here for tape and reel specifications, available at:](#)

[http://www.fairchildsemi.com/products/discrete/pdf/soic8\\_tr.pdf](http://www.fairchildsemi.com/products/discrete/pdf/soic8_tr.pdf)






Package drawings are provided as a service to customers considering Fairchild components. Drawings may change in any manner without notice. Please note the revision and/or date on the drawing and contact a Fairchild Semiconductor representative to verify or obtain the most recent revision. Package specifications do not expand the terms of Fairchild's worldwide terms and conditions, specifically the warranty therein, which covers Fairchild products.

Always visit Fairchild Semiconductor's online packaging area for the most recent package drawings:  
<http://www.fairchildsemi.com/packaging/>



**TRADEMARKS**

The following includes registered and unregistered trademarks and service marks, owned by Fairchild Semiconductor and/or its global subsidiaries, and is not intended to be an exhaustive list of all such trademarks.

- |   |                          |   |   |
|---|--------------------------|---|---|
| Build it Now™   | FPST™                    | PDP SPM™  | The Power Franchise®  |
| CorePLUS™   | F-PFST™                  | Power-SPM™  |  |
| CorePOWER™  | FRFET®                   | PowerTrench®  | TinyBoost™  |
| CROSSVOLT™  | Global Power Resource SM | Programmable Active Droop™  | TinyBuck™   |
| CTL™  | Green FPST™              | QFET®   | TinyLogic®  |
| Current Transfer Logic™   | Green FPST™ e-Series™    | QST™  | TINYOPTO™   |
| EcoSPARK®   | GTO™                     | Quiet Series™   | TinyPower™  |
| EfficientMax™   | IntelliMAX™              | RapidConfigure™   | TinyPWM™  |
| EZSWITCH™ *   | ISOPLANAR™               | Saving our world, 1mW at a time™  | TinyWire™   |
|  | MegaBuck™                | SmartMax™   | μSerDes™  |
|  | MICROCOUPLER™            | SMART START™  |  |
| Fairchild®  | MicroFET™                | SPM®  | UHC®  |
| Fairchild Semiconductor®  | MicroPak™                | STEALTH™  | Ultra FRFET™  |
| FACT Quiet Series™  | MillerDrive™             | SuperFET™   | UniFET™   |
| FACT®   | MotionMax™               | SuperSOT™.3   | Vcx™  |
| FAST®   | Motion-SPM™              | SuperSOT™.6   | VisualMax™  |
| FastvCore™  | OPTOLOGIC®               | SuperSOT™.8   |   |
| FlashWriter® *  | OPTOPLANAR®              | SupreMOS™   |   |
|   |                          | SyncFET™  |   |
|   |                          |  |   |

\* EZSWITCH™ and FlashWriter® are trademarks of System General Corporation, used under license by Fairchild Semiconductor.

**DISCLAIMER**

FAIRCHILD SEMICONDUCTOR RESERVES THE RIGHT TO MAKE CHANGES WITHOUT FURTHER NOTICE TO ANY PRODUCTS HEREIN TO IMPROVE RELIABILITY, FUNCTION, OR DESIGN. FAIRCHILD DOES NOT ASSUME ANY LIABILITY ARISING OUT OF THE APPLICATION OR USE OF ANY PRODUCT OR CIRCUIT DESCRIBED HEREIN; NEITHER DOES IT CONVEY ANY LICENSE UNDER ITS PATENT RIGHTS, NOR THE RIGHTS OF OTHERS. THESE SPECIFICATIONS DO NOT EXPAND THE TERMS OF FAIRCHILD'S WORLDWIDE TERMS AND CONDITIONS, SPECIFICALLY THE WARRANTY THEREIN, WHICH COVERS THESE PRODUCTS.

**LIFE SUPPORT POLICY**

FAIRCHILD'S PRODUCTS ARE NOT AUTHORIZED FOR USE AS CRITICAL COMPONENTS IN LIFE SUPPORT DEVICES OR SYSTEMS WITHOUT THE EXPRESS WRITTEN APPROVAL OF FAIRCHILD SEMICONDUCTOR CORPORATION.

As used herein:

1. Life support devices or systems are devices or systems which, (a) are intended for surgical implant into the body or (b) support or sustain life, and (c) whose failure to perform when properly used in accordance with instructions for use provided in the labeling, can be reasonably expected to result in a significant injury of the user.
2. A critical component in any component of a life support, device, or system whose failure to perform can be reasonably expected to cause the failure of the life support device or system, or to affect its safety or effectiveness.

**ANTI-COUNTERFEITING POLICY**

Fairchild Semiconductor Corporation's Anti-Counterfeiting Policy. Fairchild's Anti-Counterfeiting Policy is also stated on our external website, [www.fairchildsemi.com](http://www.fairchildsemi.com), under Sales Support.

Counterfeiting of semiconductor parts is a growing problem in the industry. All manufacturers of semiconductor products are experiencing counterfeiting of their parts. Customers who inadvertently purchase counterfeit parts experience many problems such as loss of brand reputation, substandard performance, failed applications, and increased cost of production and manufacturing delays. Fairchild is taking strong measures to protect ourselves and our customers from the proliferation of counterfeit parts. Fairchild strongly encourages customers to purchase Fairchild parts either directly from Fairchild or from Authorized Fairchild Distributors who are listed by country on our web page cited above. Products customers buy either from Fairchild directly or from Authorized Fairchild Distributors are genuine parts, have full traceability, meet Fairchild's quality standards for handling and storage and provide access to Fairchild's full range of up-to-date technical and product information. Fairchild and our Authorized Distributors will stand behind all warranties and will appropriately address any warranty issues that may arise. Fairchild will not provide any warranty coverage or other assistance for parts bought from Unauthorized Sources. Fairchild is committed to combat this global problem and encourage our customers to do their part in stopping this practice by buying direct or from authorized distributors.

**PRODUCT STATUS DEFINITIONS**

**Definition of Terms**

Datasheet Identification	Product Status	Definition
Advance Information	Formative / In Design	Datasheet contains the design specifications for product development. Specifications may change in any manner without notice.
Preliminary	First Production	Datasheet contains preliminary data; supplementary data will be published at a later date. Fairchild Semiconductor reserves the right to make changes at any time without notice to improve design.
No Identification Needed	Full Production	Datasheet contains final specifications. Fairchild Semiconductor reserves the right to make changes at any time without notice to improve the design.
Obsolete	Not In Production	Datasheet contains specifications on a product that is discontinued by Fairchild Semiconductor. The datasheet is for reference information only.

Rev. 135

ON Semiconductor and  are trademarks of Semiconductor Components Industries, LLC dba ON Semiconductor or its subsidiaries in the United States and/or other countries. ON Semiconductor owns the rights to a number of patents, trademarks, copyrights, trade secrets, and other intellectual property. A listing of ON Semiconductor's product/patent coverage may be accessed at [www.onsemi.com/site/pdf/Patent-Marking.pdf](http://www.onsemi.com/site/pdf/Patent-Marking.pdf). ON Semiconductor reserves the right to make changes without further notice to any products herein. ON Semiconductor makes no warranty, representation or guarantee regarding the suitability of its products for any particular purpose, nor does ON Semiconductor assume any liability arising out of the application or use of any product or circuit, and specifically disclaims any and all liability, including without limitation special, consequential or incidental damages. Buyer is responsible for its products and applications using ON Semiconductor products, including compliance with all laws, regulations and safety requirements or standards, regardless of any support or applications information provided by ON Semiconductor. "Typical" parameters which may be provided in ON Semiconductor data sheets and/or specifications can and do vary in different applications and actual performance may vary over time. All operating parameters, including "Typicals" must be validated for each customer application by customer's technical experts. ON Semiconductor does not convey any license under its patent rights nor the rights of others. ON Semiconductor products are not designed, intended, or authorized for use as a critical component in life support systems or any FDA Class 3 medical devices or medical devices with a same or similar classification in a foreign jurisdiction or any devices intended for implantation in the human body. Should Buyer purchase or use ON Semiconductor products for any such unintended or unauthorized application, Buyer shall indemnify and hold ON Semiconductor and its officers, employees, subsidiaries, affiliates, and distributors harmless against all claims, costs, damages, and expenses, and reasonable attorney fees arising out of, directly or indirectly, any claim of personal injury or death associated with such unintended or unauthorized use, even if such claim alleges that ON Semiconductor was negligent regarding the design or manufacture of the part. ON Semiconductor is an Equal Opportunity/Affirmative Action Employer. This literature is subject to all applicable copyright laws and is not for resale in any manner.

## PUBLICATION ORDERING INFORMATION

### LITERATURE FULFILLMENT:

Literature Distribution Center for ON Semiconductor  
19521 E. 32nd Pkwy, Aurora, Colorado 80011 USA  
**Phone:** 303-675-2175 or 800-344-3860 Toll Free USA/Canada  
**Fax:** 303-675-2176 or 800-344-3867 Toll Free USA/Canada  
**Email:** [orderlit@onsemi.com](mailto:orderlit@onsemi.com)

**N. American Technical Support:** 800-282-9855 Toll Free  
USA/Canada  
**Europe, Middle East and Africa Technical Support:**  
Phone: 421 33 790 2910  
**Japan Customer Focus Center**  
Phone: 81-3-5817-1050

**ON Semiconductor Website:** [www.onsemi.com](http://www.onsemi.com)  
**Order Literature:** <http://www.onsemi.com/orderlit>  
For additional information, please contact your local  
Sales Representative