

PLEASE CHECK WWW.MOLEX.COM FOR LATEST PART INFORMATION

Part Number: [0003092022](#)
Status: **Active**
Overview: Standard .093" Pin and Socket Connectors
Description: 2.36mm Diameter Standard .093" Pin and Socket Plug Housing, 2 Circuits, without Mounting Ears

Documents:

3D Model	Product Specification PS-43660-9999-001 (PDF)
Drawing (PDF)	Packaging Specification PK-1545-001-001 (PDF)
Product Specification PS-02-09 (PDF)	RoHS Certificate of Compliance (PDF)

Agency Certification

CSA	LR19980
UL	E29179

General

Product Family	Crimp Housings
Series	1545
Application	Power, Wire-to-Wire
Comments	Glow Wire Equivalent Part Number 50-36-1686 . Polarized to Mating Part, 17.0A max. can be achieved when housing is used with 42477 or 42478 terminals
Overview	Standard .093" Pin and Socket Connectors
Product Name	Standard .093"
UPC	800753614819

Physical

Breakaway	No
Circuits (maximum)	2
Circuits Detail	1x2
Color - Resin	Natural
Flammability	94V-2
Gender	Plug
Glow-Wire Compliant	No
Keying to Mating Part	None
Lock to Mating Part	Yes
Material - Resin	Nylon
Net Weight	1.449/g
Number of Rows	1
Packaging Type	Bag
Panel Mount	No
Pitch - Mating Interface	6.30mm
Pitch - Termination Interface	6.30mm
Stackable	No
Temperature Range - Operating	-40°C to +105°C

Electrical

Current - Maximum per Contact	14.0A
-------------------------------	-------

Solder Process Data

Lead-freeProcess Capability	N/A
-----------------------------	-----

Material Info

Engineering Number	1545-P1
--------------------	---------

Reference - Drawing Numbers

Packaging Specification	PK-1545-001-001
Product Specification	PS-02-09, PS-43660-9999-001

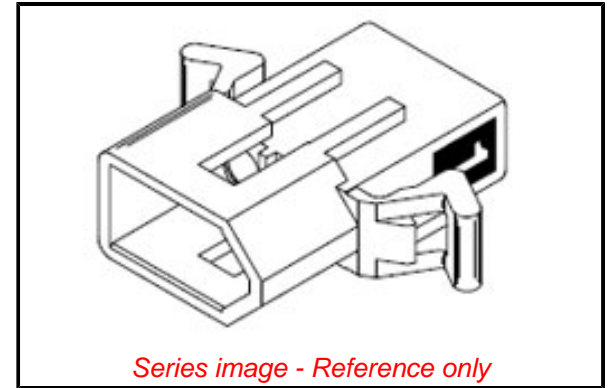

EU ELV

Not Relevant

EU RoHS

Compliant

REACH SVHC

Not Contained Per -ED/01/2017 (12 January 2017)

Halogen-Free

Status

Low-Halogen

Need more information on product environmental compliance?

Email productcompliance@molex.com
Please visit the [Contact Us](#) section for any non-product compliance questions.

China ROHS

ELV

RoHS Phthalates

Green Image

Not Relevant

Not Contained

Search Parts in this Series

[1545 Series](#)

Mates With

[03-09-1022](#) , [03-09-1027](#) , [03-09-1161](#) ,, [03-09-6021](#)

Use With

[1189](#) Crimp Terminals, [1190](#) Crimp Terminals, [1376](#) Male PC Tail Terminals, [1377](#) Female PC Tail Terminals, [1380](#) Male Crimp Terminals, [1381](#) Female Crimp Terminals, [1433](#) Crimp Terminals, [1434](#) Male Crimp Terminals, [1973](#) Male

This document was generated on 05/29/2017

PLEASE CHECK WWW.MOLEX.COM FOR LATEST PART INFORMATION