

BV_{CES}	430±30V
I_C	20A
$V_{CE(sat)}$ (Typ.)	1.6V
E_{AS}	250mJ

●Features

- 1) Low Collector - Emitter Saturation Voltage
- 2) High Self-Clamped Inductive Switching Energy
- 3) Built in Gate-Emitter Protection Diode
- 4) Built in Gate-Emitter Resistance
- 5) Qualified to AEC-Q101
- 6) Pb - free Lead Plating ; RoHS Compliant

●Applications

Ignition Coil Driver Circuits
Solenoid Driver Circuits

●Outline

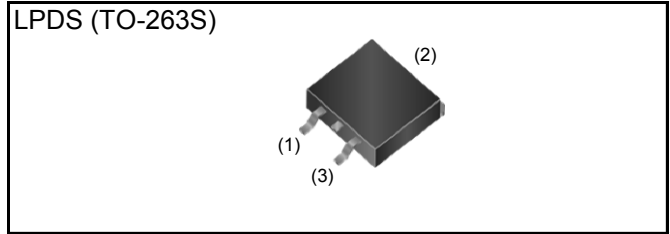

●Inner Circuit

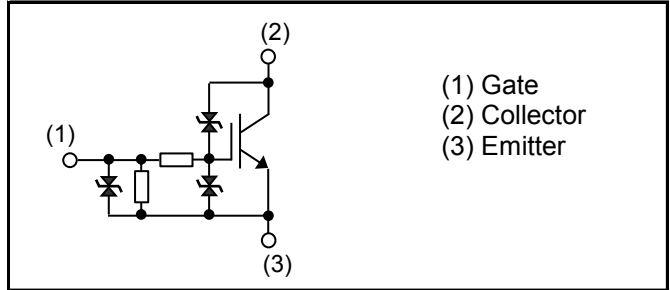

●Packaging Specifications

Type	Packaging	Taping
	Reel Size (mm)	330
	Tape Width (mm)	24
	Basic Ordering Unit (pcs)	1,000
	Packing Code	TL
	Marking	RGPR20NS43

●Absolute Maximum Ratings (at $T_C = 25^\circ\text{C}$ unless otherwise specified)

Parameter	Symbol	Value	Unit	
Collector - Emitter Voltage	V_{CES}	460	V	
Emitter-Collector Voltage ($V_{GE} = 0V$)	V_{EC}	25	V	
Gate - Emitter Voltage	V_{GES}	±10	V	
Collector Current	I_C	20	A	
Avalanche Energy (Single Pulse)	$T_j = 25^\circ\text{C}$	E_{AS}	250	mJ
	$T_j = 150^\circ\text{C}$	E_{AS}^{*2}	150	mJ
Power Dissipation	P_D	107	W	
Operating Junction Temperature	T_j	-40 to +175	$^\circ\text{C}$	
Storage Temperature	T_{stg}	-55 to +175	$^\circ\text{C}$	

●Thermal Resistance

Parameter	Symbol	Values			Unit
		Min.	Typ.	Max.	
Thermal Resistance IGBT Junction - Case	$R_{\theta(j-c)}$	-	-	1.40	°C/W

●Electrical Characteristics (at $T_j = 25^\circ\text{C}$ unless otherwise specified)

Parameter	Symbol	Conditions	Values			Unit
			Min.	Typ.	Max.	
Collector - Emitter Breakdown Voltage	BV_{CES}	$I_C = 2\text{mA}, V_{GE} = 0\text{V}$ $T_j = 25^\circ\text{C}$	400	430	460	V
		$T_j = -40 \text{ to } 175^\circ\text{C}^{*2}$	395	-	465	V
Emitter - Collector Breakdown Voltage	BV_{EC}	$I_C = -10\text{mA}, V_{GE} = 0\text{V}$	25	35	-	V
Gate - Emitter Breakdown Voltage	BV_{GES}	$I_G = \pm 5\text{mA}, V_{CE} = 0\text{V}$	± 12	-	± 17	V
Collector Cut - off Current	I_{CES}	$V_{CE} = 300\text{V}, V_{GE} = 0\text{V}$ $T_j = 25^\circ\text{C}$	-	-	7	μA
		$T_j = 150^\circ\text{C}^{*2}$	-	-	100	μA
Gate - Emitter Leakage Current	I_{GES}	$V_{GE} = \pm 10\text{V}, V_{CE} = 0\text{V}$	± 0.4	± 0.6	± 1.2	mA
Gate - Emitter Threshold Voltage	$V_{GE(th)}$	$V_{CE} = 5\text{V}, I_C = 10\text{mA}$ $T_j = 25^\circ\text{C}$	1.3	1.7	2.1	V
		$T_j = 150^\circ\text{C}^{*2}$	-	1.3	-	V
Collector - Emitter Saturation Voltage	$V_{CE(sat)}$	$I_C = 10\text{A}, V_{GE} = 5\text{V}$ $T_j = 25^\circ\text{C}$	-	1.60	2.00	V
		$T_j = 150^\circ\text{C}$	-	1.80	-	V
Collector - Emitter Saturation Voltage	$V_{CE(sat)}$	$I_C = 4\text{A}, V_{GE} = 4.5\text{V}$ $T_j = 25^\circ\text{C}$	-	1.17	1.50	V
		$T_j = 150^\circ\text{C}$	-	1.13	-	V

●Electrical Characteristics (at $T_j = 25^\circ\text{C}$ unless otherwise specified)

Parameter	Symbol	Conditions	Values			Unit
			Min.	Typ.	Max.	
Collector - Emitter Saturation Voltage	$V_{CE(sat)}$	$I_C = 10\text{A}, V_{GE} = 4\text{V}$ $T_j = 25^\circ\text{C}$	-	1.70	2.10	V
		$T_j = 150^\circ\text{C}$	-	1.90	-	V
Input Capacitance	C_{ies}	$V_{CE} = 10\text{V}$	-	1000	-	pF
Output Capacitance	C_{oes}	$V_{GE} = 0\text{V}$	-	175	-	
Reverse Transfer Capacitance	C_{res}	$f = 1\text{MHz}$	-	55	-	
Total Gate Charge	Q_g	$V_{CE} = 12\text{V}, I_C = 10\text{A},$ $V_{GE} = 5\text{V}$	-	14	-	nC
Turn - on Delay Time ^{*1,*2}	$t_{d(on)}$	$I_C = 8\text{A}, V_{CC} = 300\text{V},$ $V_{GE} = 5\text{V}, R_G = 100\Omega,$ $L = 5\text{mH}, T_j = 25^\circ\text{C}$	0.09	0.17	0.50	μs
Rise Time ^{*1,*2}	t_r		0.10	0.18	0.50	
Turn - off Delay Time ^{*1,*2}	$t_{d(off)}$		0.8	1.3	4.0	
Fall Time ^{*1,*2}	t_f		1.4	2.4	6.0	
Turn - on Delay Time ^{*1}	$t_{d(on)}$	$I_C = 8\text{A}, V_{CC} = 300\text{V},$ $V_{GE} = 5\text{V}, R_G = 100\Omega,$ $L = 5\text{mH}, T_j = 150^\circ\text{C}$	-	0.16	-	μs
Rise Time ^{*1}	t_r		-	0.23	-	
Turn - off Delay Time ^{*1}	$t_{d(off)}$		-	1.5	-	
Fall Time ^{*1}	t_f		-	3.9	-	
Avalanche Energy (Single Pulse)	E_{AS}	$L = 5\text{mH}, V_{GE} = 5\text{V},$ $V_{CC} = 30\text{V}, R_G = 1\text{k}\Omega,$ $T_j = 25^\circ\text{C}$	250	-	-	mJ
		$T_j = 150^\circ\text{C}^{*2}$	150	-	-	mJ
Gate Series Resistance	R_G		70	100	130	Ω
Gate - Emitter Resistance	R_{GE}		8	16	24	k Ω

*1) Assurance items according to our measurement definition (Fig.18)

*2) Design assurance items

●Electrical Characteristic Curves

Fig.1 Typical Output Characteristics

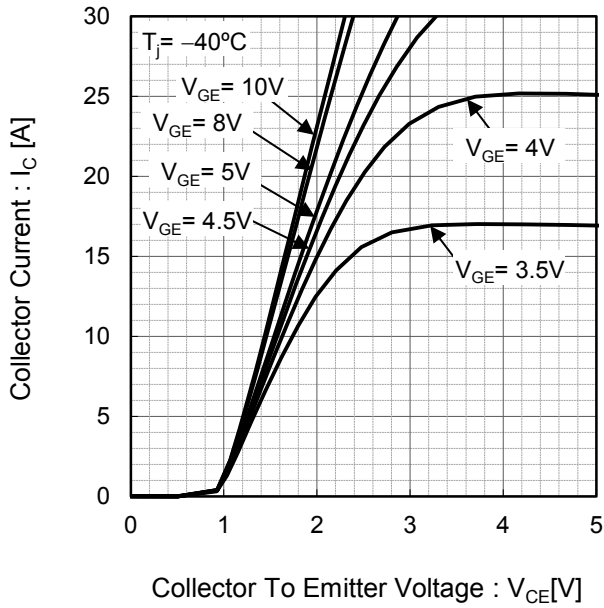

Fig.2 Typical Output Characteristics

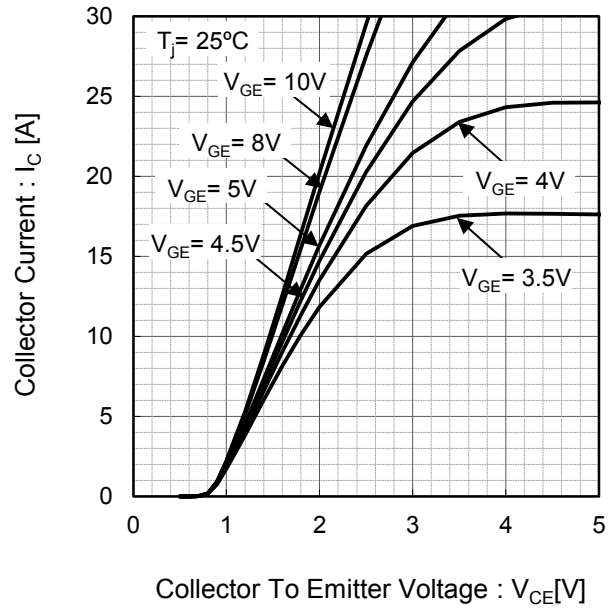

Fig.3 Typical Output Characteristics

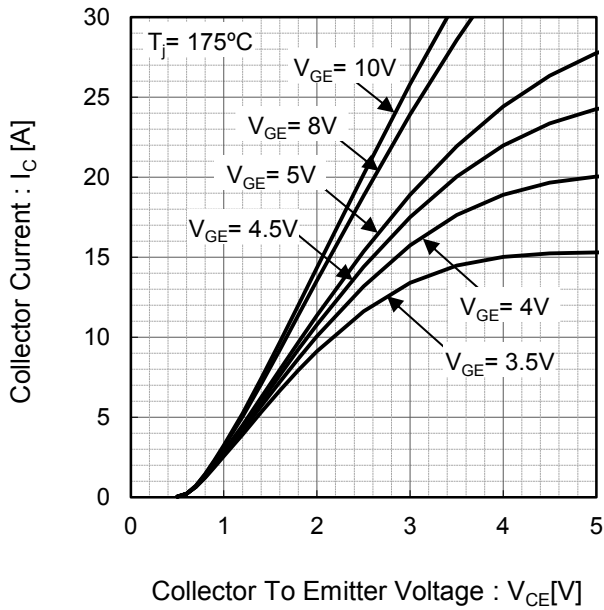
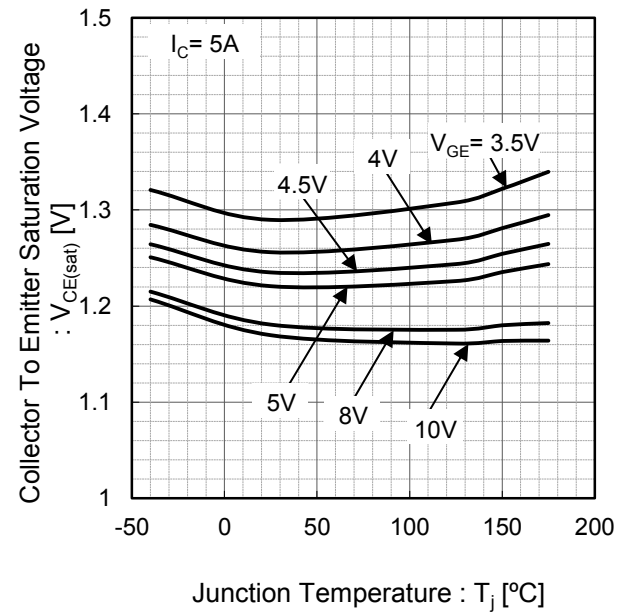

Fig.4 Typical Collector To Emitter Saturation Voltage vs. Junction Temperature



●Electrical Characteristic Curves

Fig.5 Typical Collector To Emitter Saturation Voltage vs. Junction Temperature

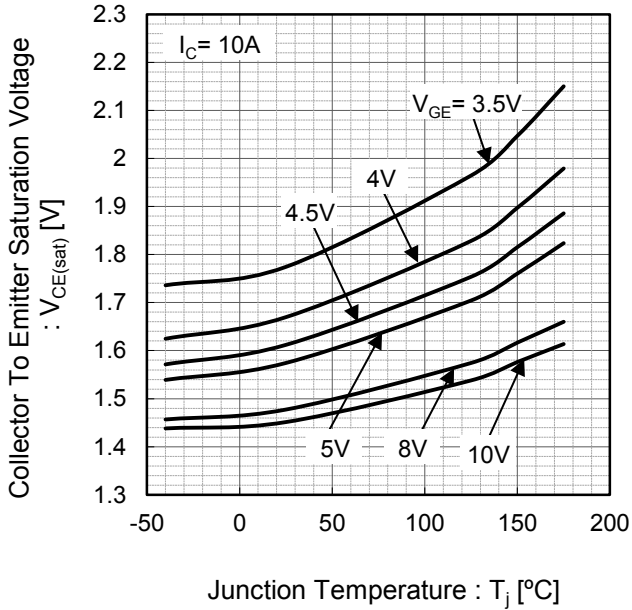

Fig.6 Typical Collector To Emitter Saturation Voltage vs. Junction Temperature

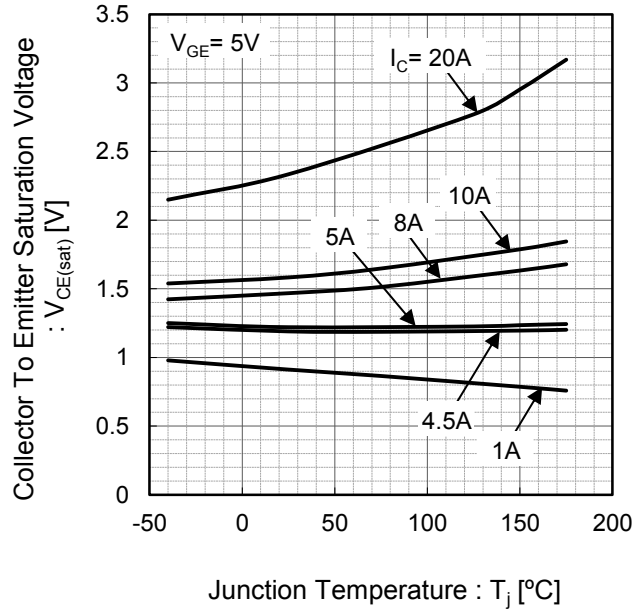

Fig.7 Typical Transfer Characteristics

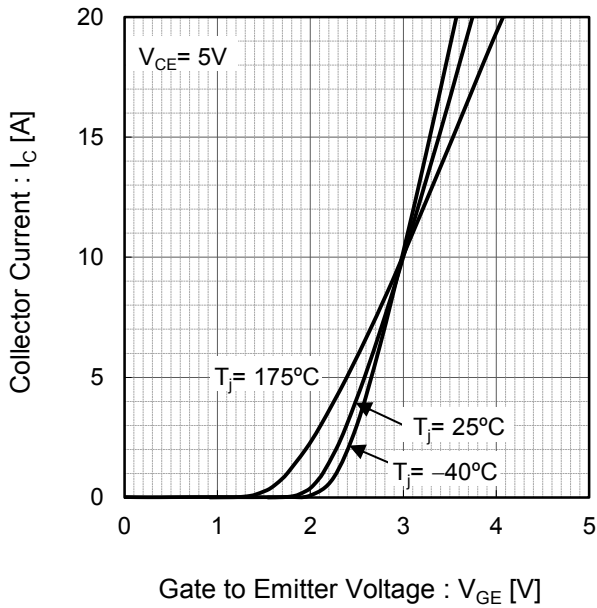
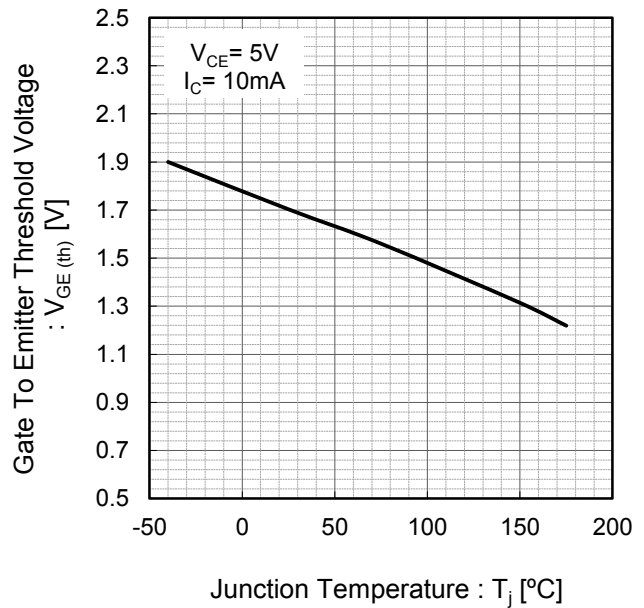

Fig.8 Typical Gate To Emitter Threshold Voltage vs. Junction Temperature



●Electrical Characteristic Curves

Fig.9 Typical Leakage Current vs. Junction Temperature

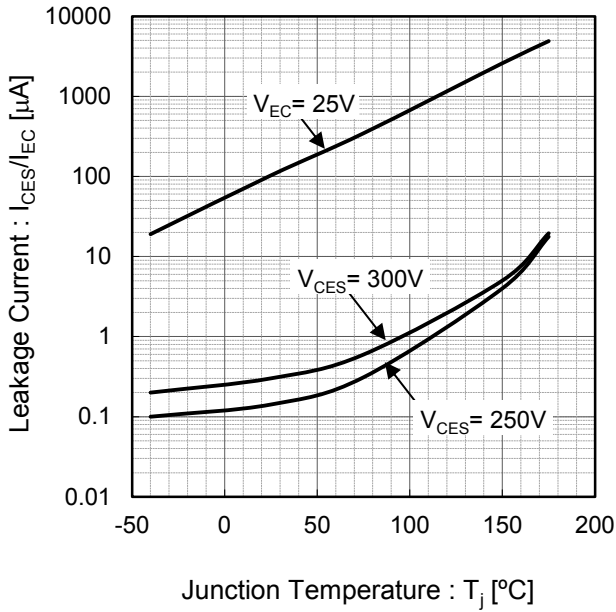

Fig.10 Typical Collector To Emitter Breakdown Voltage vs. Junction Temperature

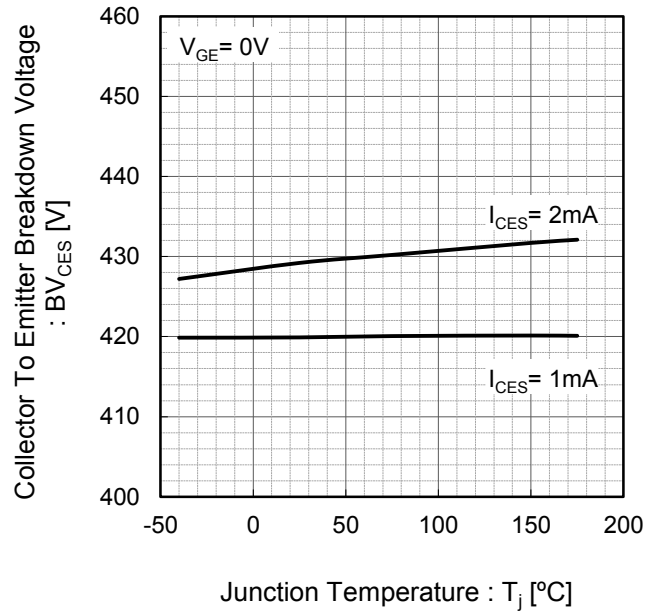

Fig.11 Typical Self Clamped Inductive Switching Current vs. Inductance

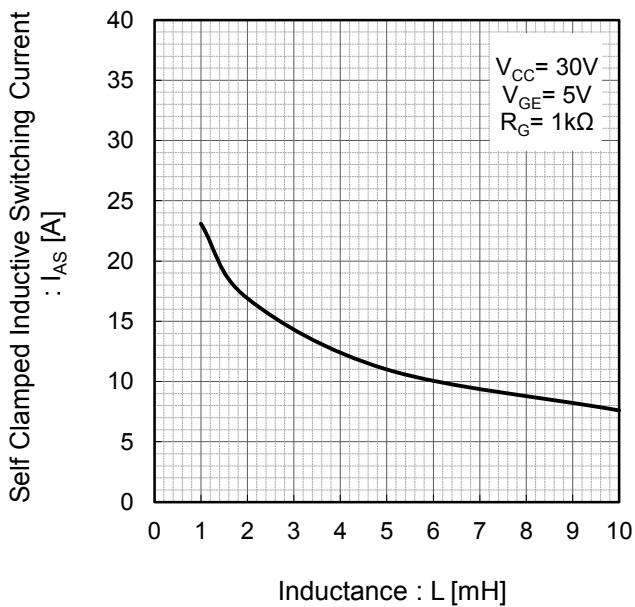
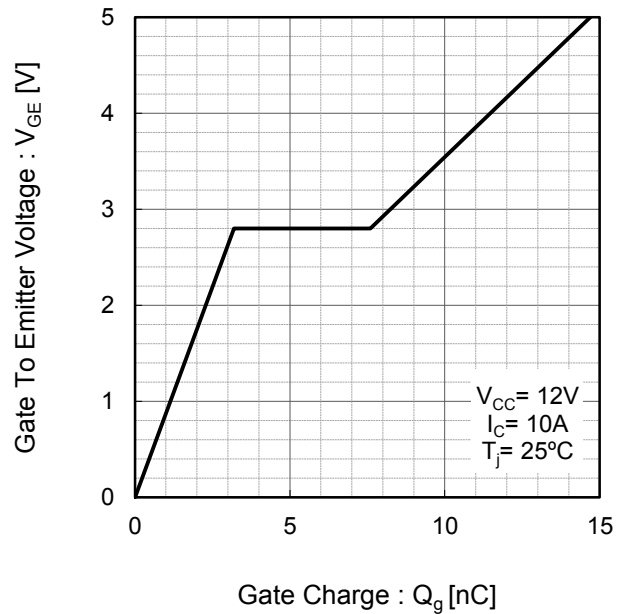

Fig.12 Typical Gate Charge



●Electrical Characteristic Curves

Fig.13 Typical Capacitance vs. Collector To Emitter Voltage

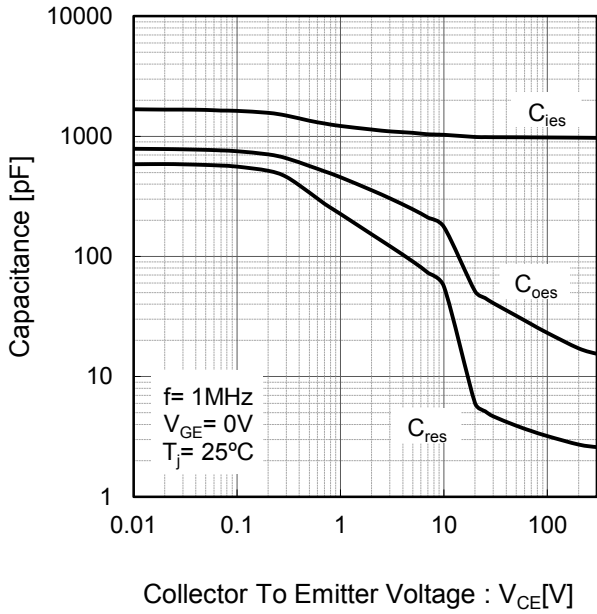

Fig.14 Typical Switching Time vs. Junction Temperature

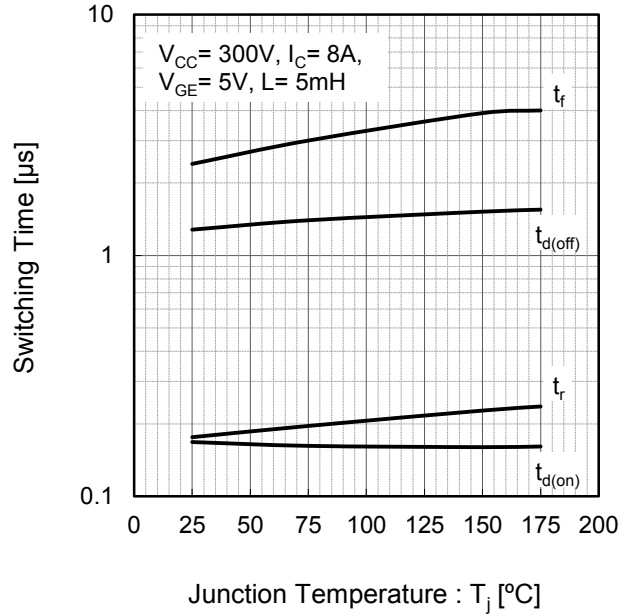
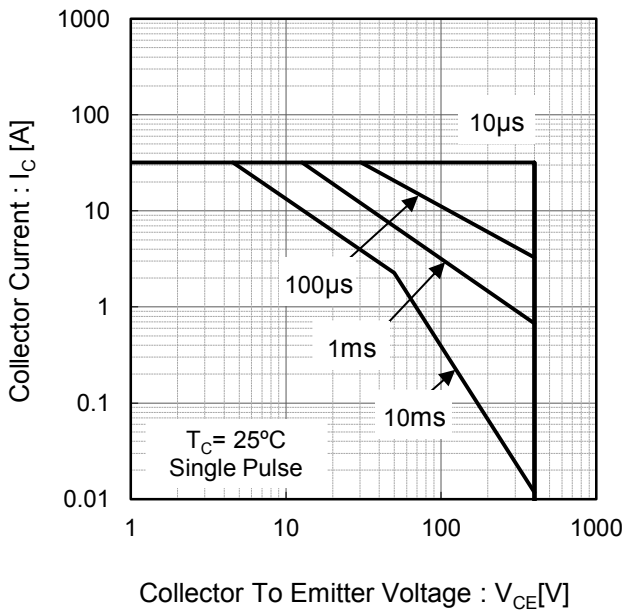
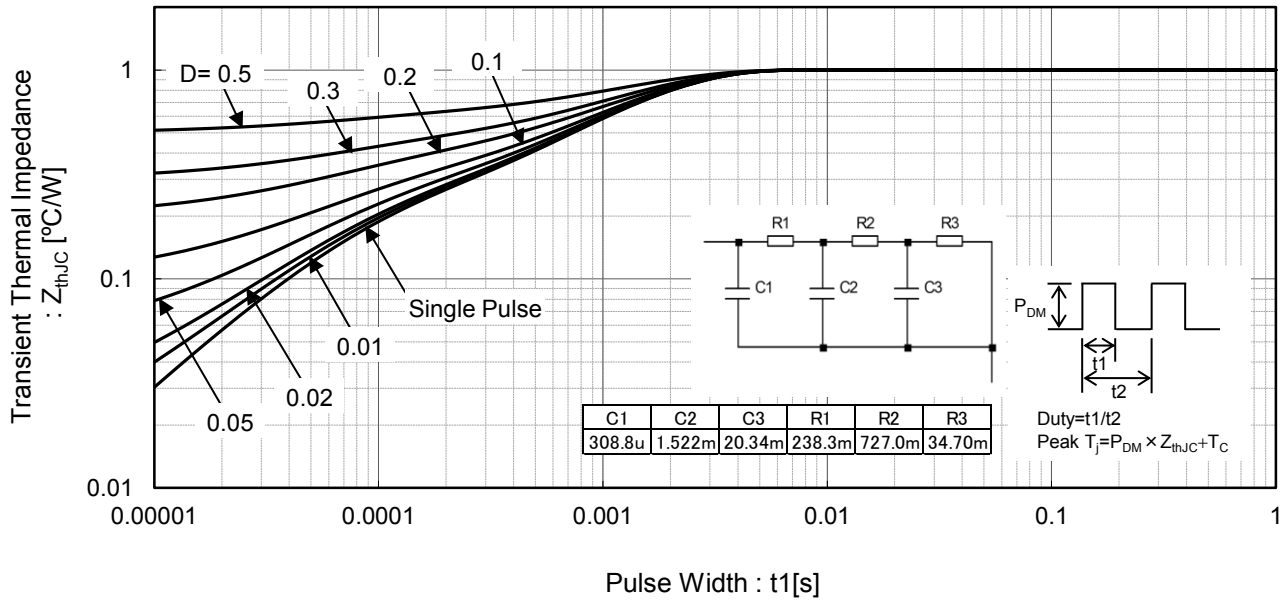

Fig.15 Forward Bias Safe Operating Area



●Electrical Characteristic Curves

Fig.16 Transient Thermal Impedance



●Inductive Load Switching Circuit and Waveform

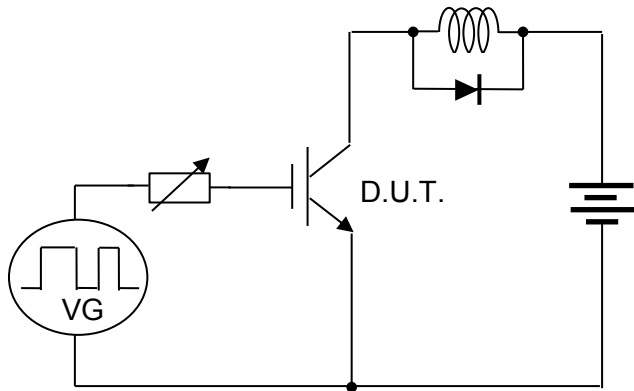

Fig.17 Inductive Load Switching Circuit

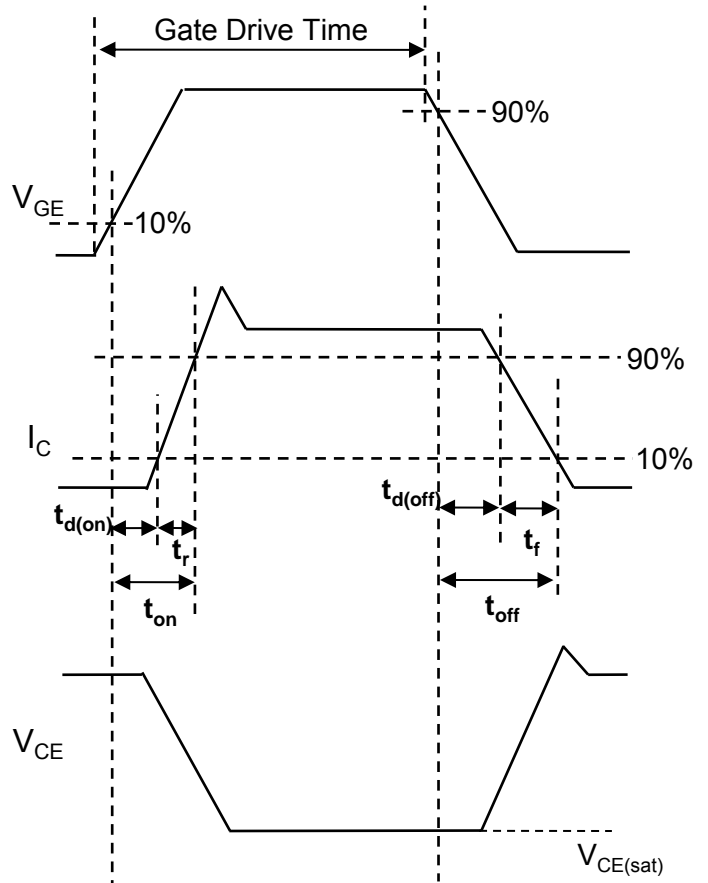

Fig.18 Inductive Load Switching Waveform

●Self Clamped Inductive Switching Circuit and Waveform

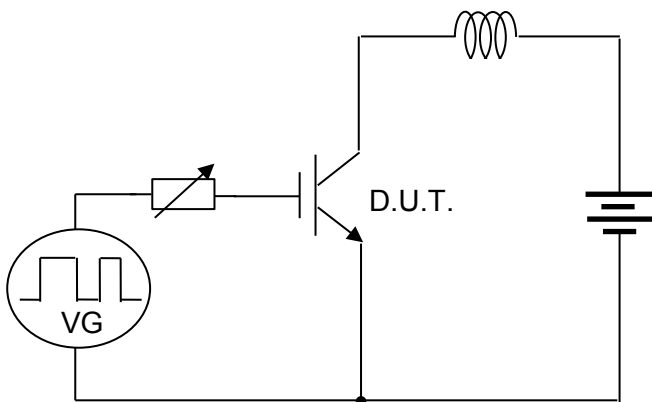

Fig.19 Self Clamped Inductive Switching Circuit

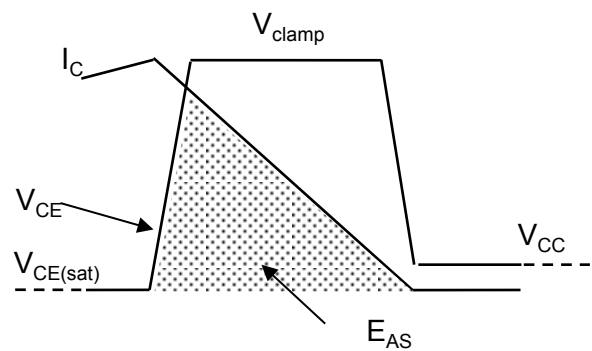

Fig.20 Self Clamped Inductive Switching Waveform

Notes

- 1) The information contained herein is subject to change without notice.
- 2) Before you use our Products, please contact our sales representative and verify the latest specifications :
- 3) Although ROHM is continuously working to improve product reliability and quality, semiconductors can break down and malfunction due to various factors.
Therefore, in order to prevent personal injury or fire arising from failure, please take safety measures such as complying with the derating characteristics, implementing redundant and fire prevention designs, and utilizing backups and fail-safe procedures. ROHM shall have no responsibility for any damages arising out of the use of our Products beyond the rating specified by ROHM.
- 4) Examples of application circuits, circuit constants and any other information contained herein are provided only to illustrate the standard usage and operations of the Products. The peripheral conditions must be taken into account when designing circuits for mass production.
- 5) The technical information specified herein is intended only to show the typical functions of and examples of application circuits for the Products. ROHM does not grant you, explicitly or implicitly, any license to use or exercise intellectual property or other rights held by ROHM or any other parties. ROHM shall have no responsibility whatsoever for any dispute arising out of the use of such technical information.
- 6) The Products specified in this document are not designed to be radiation tolerant.
- 7) For use of our Products in applications requiring a high degree of reliability (as exemplified below), please contact and consult with a ROHM representative : transportation equipment (i.e. cars, ships, trains), primary communication equipment, traffic lights, fire/crime prevention, safety equipment, medical systems, servers, solar cells, and power transmission systems.
- 8) Do not use our Products in applications requiring extremely high reliability, such as aerospace equipment, nuclear power control systems, and submarine repeaters.
- 9) ROHM shall have no responsibility for any damages or injury arising from non-compliance with the recommended usage conditions and specifications contained herein.
- 10) ROHM has used reasonable care to ensure the accuracy of the information contained in this document. However, ROHM does not warrant that such information is error-free, and ROHM shall have no responsibility for any damages arising from any inaccuracy or misprint of such information.
- 11) Please use the Products in accordance with any applicable environmental laws and regulations, such as the RoHS Directive. For more details, including RoHS compatibility, please contact a ROHM sales office. ROHM shall have no responsibility for any damages or losses resulting from non-compliance with any applicable laws or regulations.
- 12) When providing our Products and technologies contained in this document to other countries, you must abide by the procedures and provisions stipulated in all applicable export laws and regulations, including without limitation the US Export Administration Regulations and the Foreign Exchange and Foreign Trade Act.
- 13) This document, in part or in whole, may not be reprinted or reproduced without prior consent of ROHM.



Thank you for your accessing to ROHM product informations.
More detail product informations and catalogs are available, please contact us.

ROHM Customer Support System

<http://www.rohm.com/contact/>



RGPR20NS43HR - Web Page

Part Number	RGPR20NS43HR
Package	LPDS
Unit Quantity	1000
Minimum Package Quantity	1000
Packing Type	Taping
Constitution Materials List	inquiry
RoHS	Yes