

## CPS250-M Series

250 Watt AC-DC Power Supplies

### Data Sheet

**Total Power:** 250 Watts  
**Input Voltage:** 90 - 264 V  
**# of Outputs:** Single

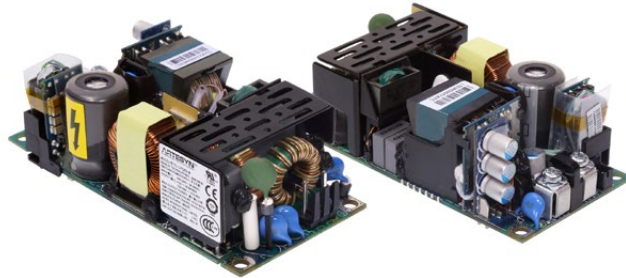

### SPECIAL FEATURES

- Designed for forced air and natural convection cooling
- Medical and ITE safety approvals, 2x MOPP
- Dual fused
- Type BF ready
- Active Power Factor Correction, 61000-3-2 compliant
- Built-in Class B EMI filter
- Less than 1U high
- LPX100 enclosure kit available
- <500 mW no-load power consumption
- For use in Class I or Class II applications
- Three-year warranty (consult factory for extended terms)

### SAFETY

- EN 60950-1 / 60601-1
- UL 60950-1 / 60601-1
- CSA
- CE LVD Mark
- CCC

### Electrical Specifications

| Input                      |   |
|----------------------------|---|
| Input voltage range        | 90 - 264 Vrms   |
| Frequency                  | 47 - 63 Hz (360 - 440 Hz with higher leakage)                   |
| Inrush current             | 70 Apk, < 1 ms, cold start                                      |
| Efficiency                 | 93% typical   |
| Leakage current            | Specified for medical approvals                                 |
| No load power              | < 500 mW  |
| Output                     |   |
| Maximum power              | 250 W, forced-air cooling<br>155 W, free-air natural convection |
| Adjustment range           | -0% / +10%  |
| Holdup time                | 10 ms @ 225 W   |
| Fan output                 | 12 V @ 500 mA   |
| Standby output             | 5 V @ 100 mA (For CPS253-M1 only)                               |
| Control and Protection     |   |
| Remote On/Off              | For CPS253-M1 only  |
| DC OK                      | For CPS253-M1 only  |
| Overvoltage protection     | Latching/AC Recycle required to restart PSU                     |
| Overcurrent protection     | Auto-recovery   |
| Short circuit protection   | Auto-recovery (impedance <50 mOhm)                              |
| Overtemperature protection | Auto-recovery with hysteresis                                   |

## Environmental Specifications

|                        |   |
|------------------------|---|
| Operating temperature  | -20 °C to +70 °C (derate at 50 °C), startup at -40 °C |
| Storage temperature    | -40 °C to +85 °C                                      |
| Operating humidity     | 5% to 90% (non-condensing)                            |
| Non-operating humidity | 5% to 95% (non-condensing)                            |
| Maximum altitude       | 5000 m (3000 m for medical), derating may apply       |

## Other Specifications

|   |  |
|---|--|
| Isolation                                     | 4000 Vac (input to output)<br>1500 Vac (input to PE; output to PE)                                   |
| Line harmonics                                | 61000-3-2, Class A   |
| Conducted EMI*                                | Level B, CISPR 22 and FCC Part 15  |
| Radiated EMI*                                 | Level B, CISPR 22 and FCC Part 15  |
| Surge immunity                                | Level 3, 61000-4-5, Criterion A  |
| Medical EMC                                   | 60601-1-2, Edition 4 (cover may be required for some tests)  |
| MTBF<br>(Telcordia, Issue 3, Method 1 Case 3) | > 2.2 Mhrs, 25 °C, 155 W Natural Convection, 115 VAC<br>> 5.1 Mhrs, 25 °C, 250 W Forced Air, 115 VAC |

\*Applies to Class I input with ground tabs tied to a common ground plane and connected to system ground. Consult Technical Reference Notes for details.

## Pin Assignments

| Connector  | Pin Number                 | Designation   | Mating Connectors  |
|--|----------------------------|---|--|
| J5 (AC Input)  | 1<br>3<br>Mounting Holes   | AC Input L1/Line<br>AC Input L2/Neutral<br>PE   | Molex 09-50-8031 housing with 45570-3000 crimp or equivalent. Use AWG 20-18 wires. |
| J0 (DC Output)   | 1<br>2<br>3<br>4<br>5<br>6 | Main Output Return<br>Main Output Return<br>Main Output Return<br>Main Output<br>Main Output<br>Main Output | Molex 09-50-8061 housing with 45570-3000 crimp or equivalent. Use AWG 20-18 wires. |
| BusBar (DC Output)<br><i>Applies to 12 V variant only.</i> | 1<br>2                     | Main Output<br>Main Output Return   | Ring terminal: Tyco 35148 or KST RV3-4 or equivalent.                              |
| J2 (Fan Supply)  | 1<br>2                     | Fan Return<br>Fan Voltage   | Cvilux CI0102S0000 housing; CI01T01MPP0 crimp; AWG 30-24.                          |
| J403<br><i>Applies to CPS253-M1 only</i>                   | 1<br>2<br>3<br>4<br>5      | 5 Vdc Standby<br>Standby Return<br>Remote Inhibit<br>DC OK<br>VFB (feedback loop pin)                       | Molex 504193-0500 with 504185-1000 crimp or equivalent. Use AWG 30-26 wires.       |

Mechanical Drawings - 12 V Variant

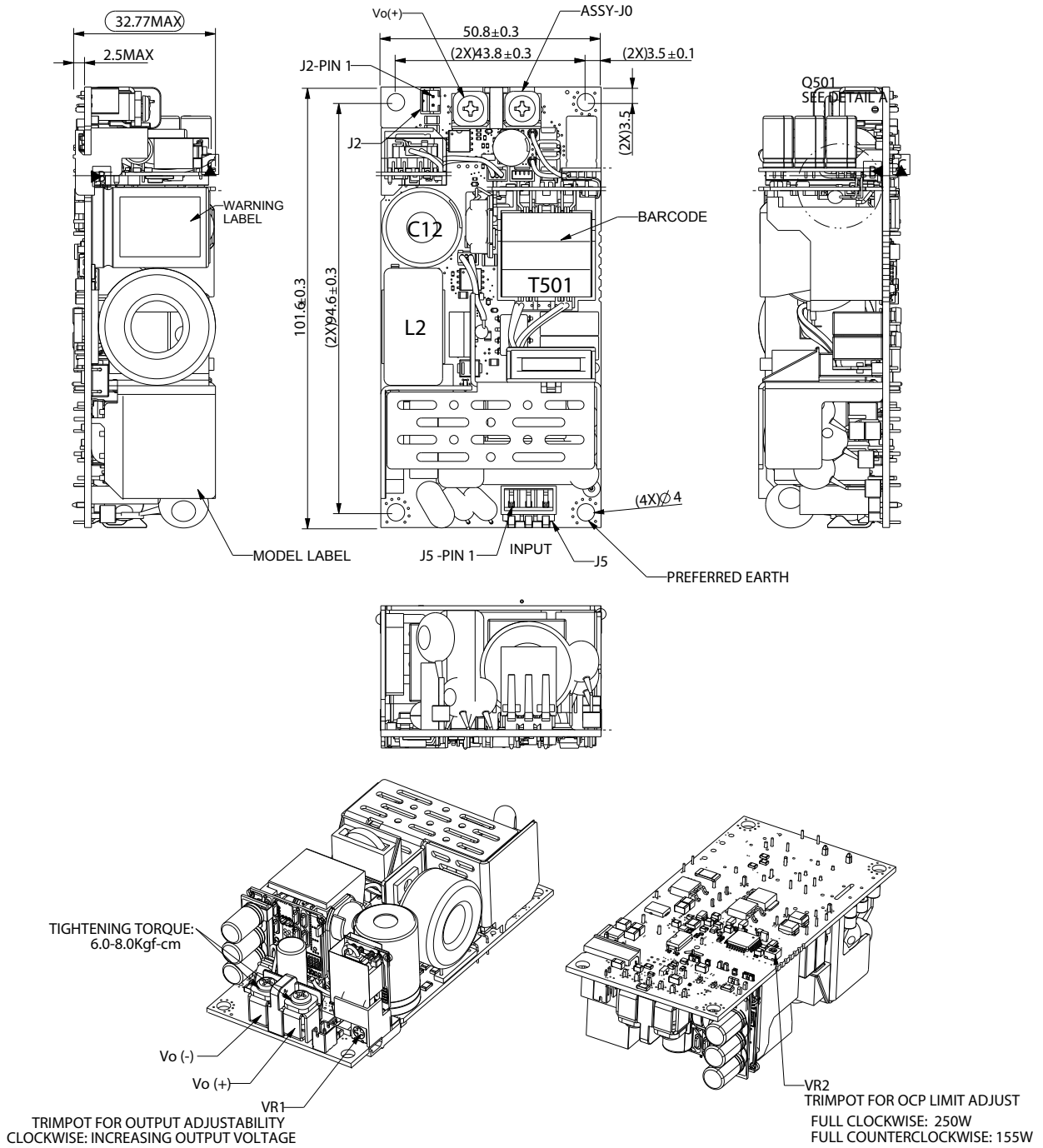

Mechanical Drawings - 24 V and 48 V Variants

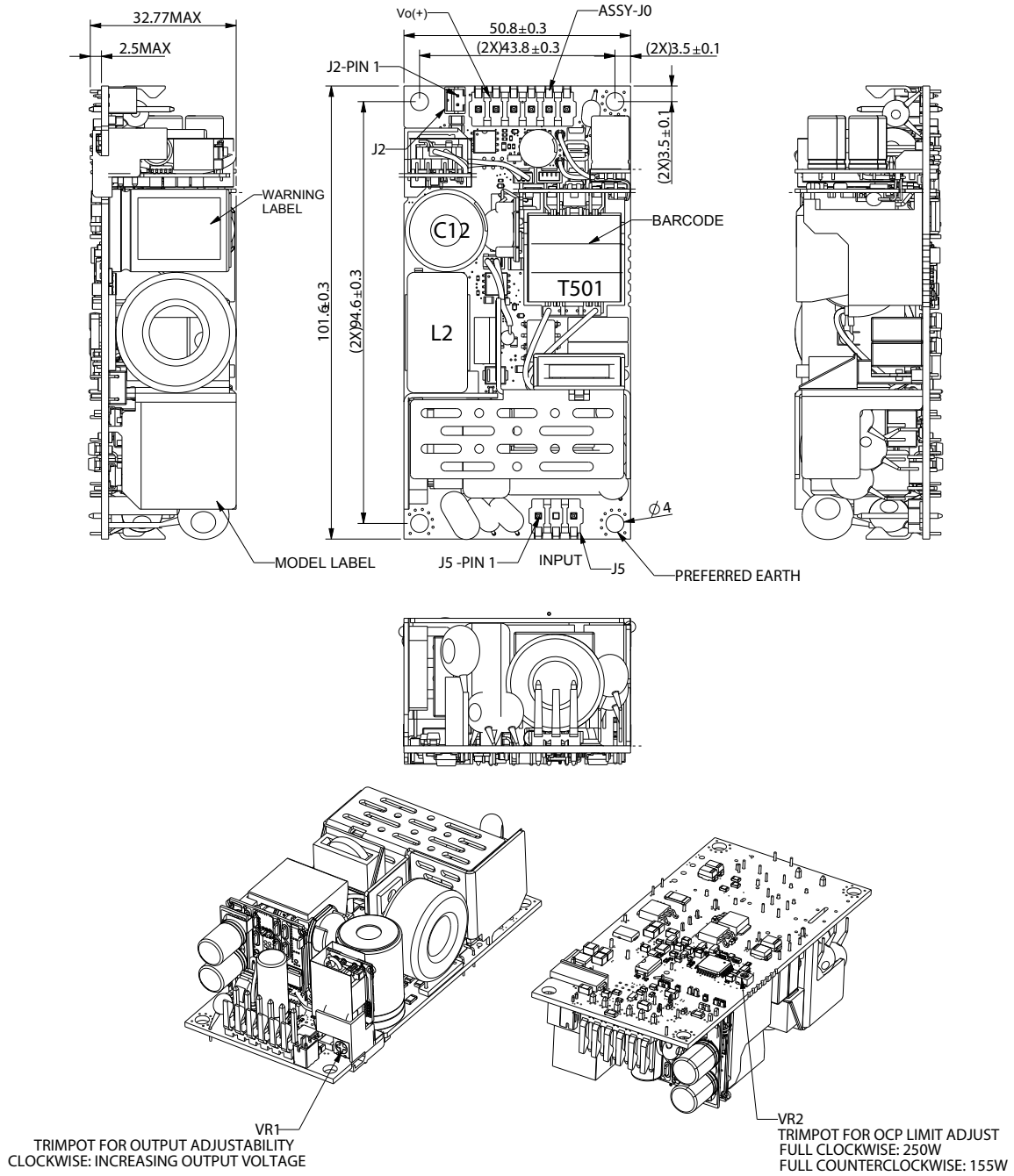

Mechanical Drawings - CPS253-M1

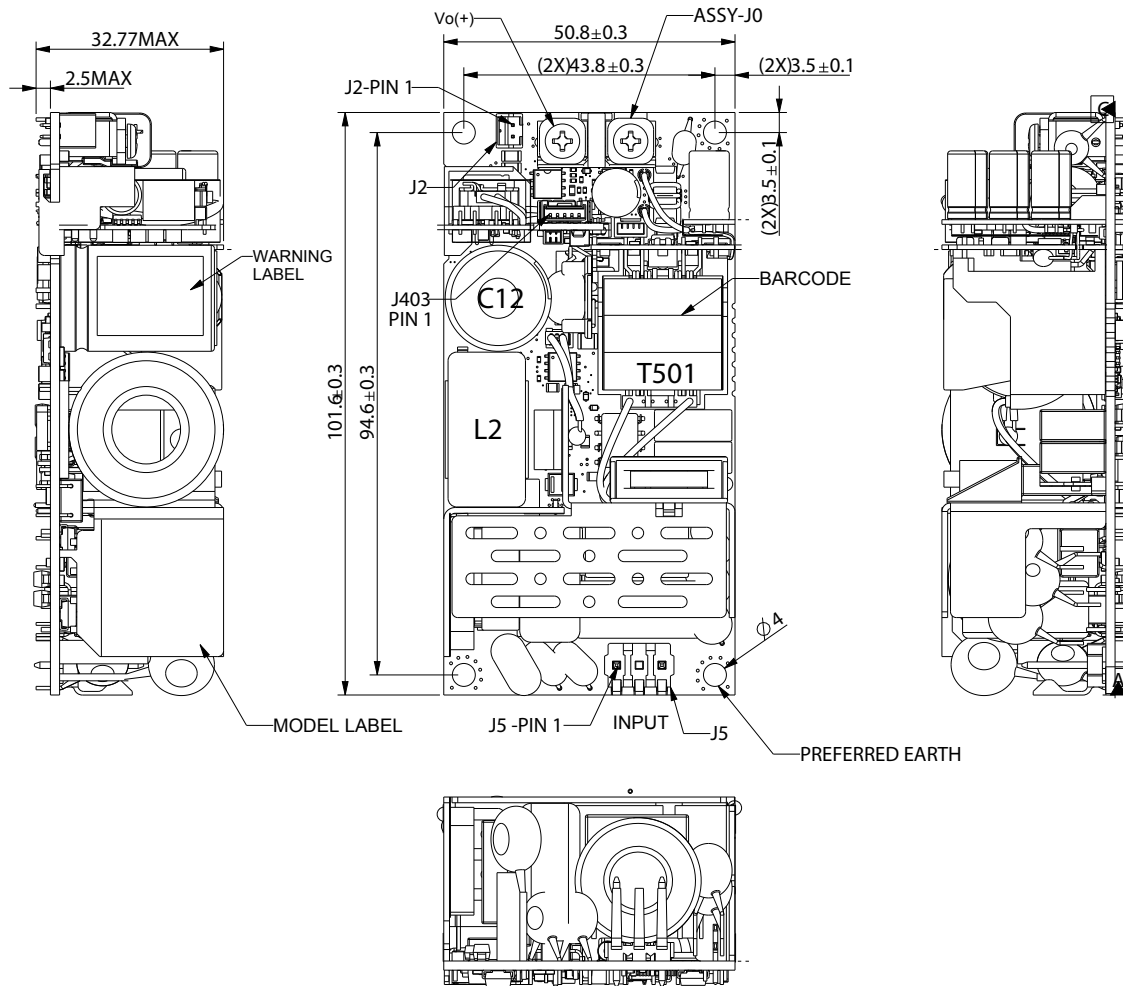

Notes:

1. OCP can not be adjusted on the fly. Default setting is for 250 W Forced Air.
2. Unit should be turned off before trimpot adjustment.
3. OCP does not vary linearly with the trimpot adjustment. It is either Full clockwise (250 W) or Full counter clockwise (155 W).
4. Thermal Hot Spot Reference - Do not exceed indicated temperature limits to ensure operation is within the component thermal derating limits. Measure the component temperatures using K type thermocouples.

| Thermal Hot Spot Reference |                   |
|----------------------------|-------------------|
| Component                  | Temperature Limit |
| L2                         | 135 °C            |
| T501                       | 145 °C            |
| Q501                       | 120 °C            |
| C12                        | 95 °C             |

## Output Power Derating

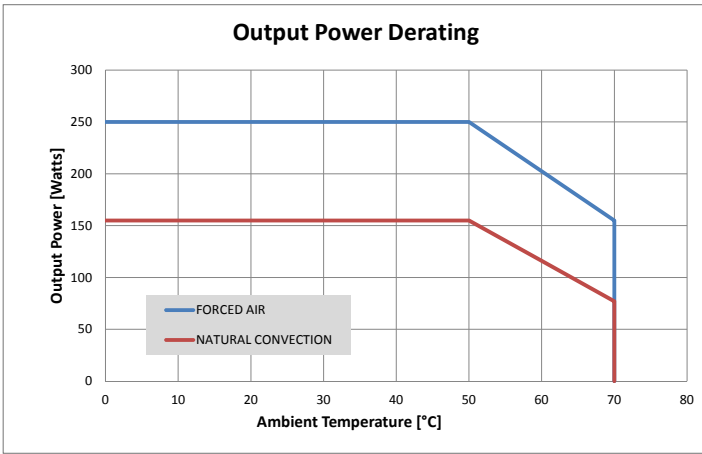

Figure 1. Output Power vs. Ambient Temperature at Natural Convection and Forced Air Cooling [300 LFM].

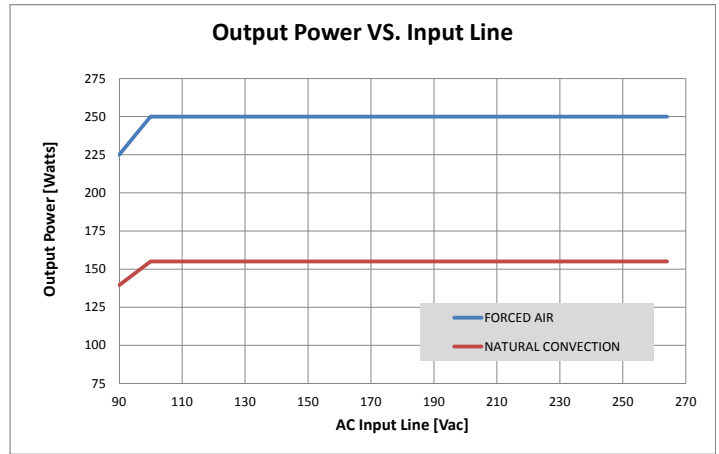

Figure 2. Output Power vs. Input Line at Natural Convection and Forced Air Cooling [300 LFM].

## Efficiency Curves

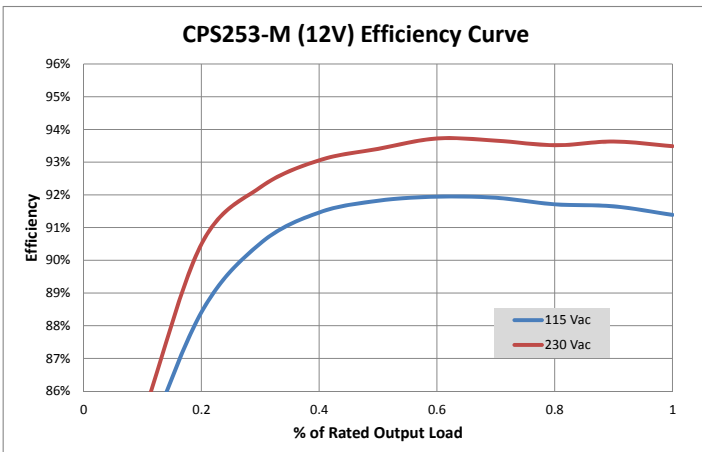

Figure 3. Typical Efficiency for 12 V Output

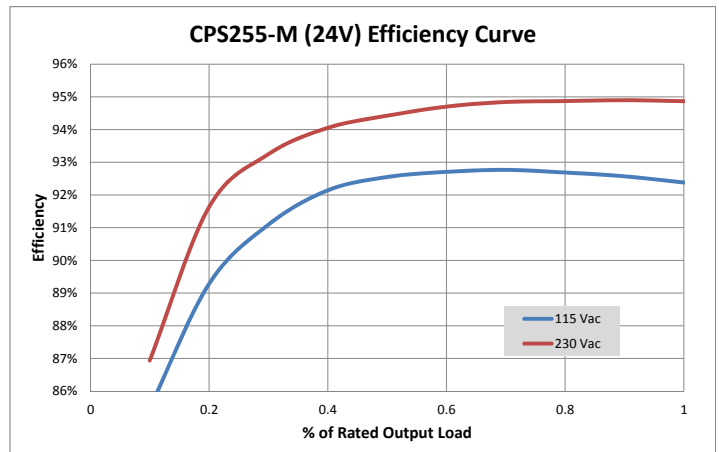

Figure 4. Typical Efficiency for 24 V Output

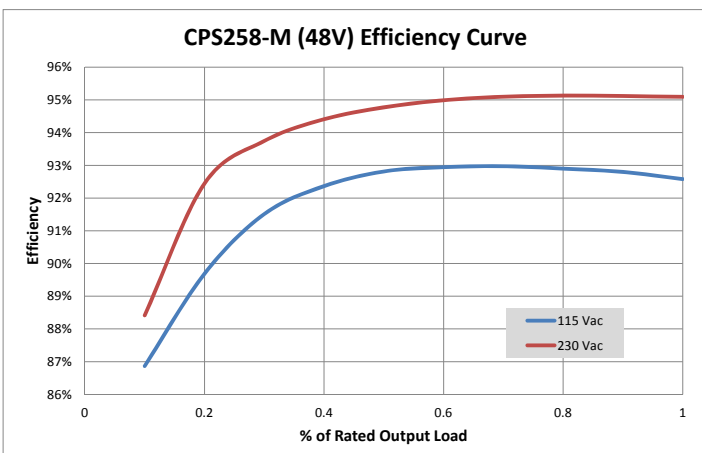

Figure 5. Typical Efficiency for 48 V Output

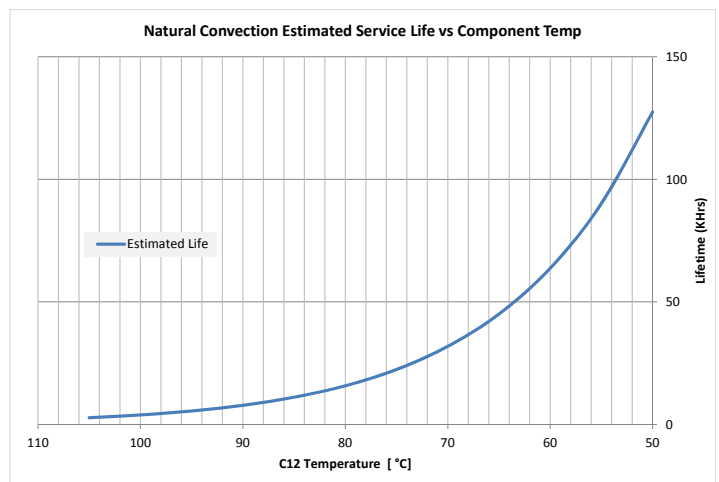

Figure 6. Estimated product useful life based on C12 (bulk capacitor) case temperature

## Ordering Information

| Model number | Output voltage | Minimum load | Max. Continuous Load (Free Air) | Peak Load (Free Air) <sup>1</sup> | Max. Continuous Load (Forced Air) <sup>2</sup> | Regulation <sup>3</sup> | Ripple (p-p) <sup>4</sup> |
|--------------|----------------|--------------|---------------------------------|-----------------------------------|--|-------------------------|---------------------------|
| CPS253-M     | 12 V           | 0 A          | 12.92 A                         | 15.5 A                            | 20.83 A  | ±2%                     | 120 mV                    |
| CPS253-M1    | 12 V           | 0 A          | 12.92 A                         | 15.5 A                            | 20.83 A  | ± 2%                    | 120 mV                    |
| CPS255-M     | 24 V           | 0 A          | 6.45 A                          | 7.74 A                            | 10.42 A  | ±2%                     | 240 mV                    |
| CPS258-M     | 48 V           | 0 A          | 3.23 A                          | 3.88 A                            | 5.21 A   | ± 2%                    | 480 mV                    |

<sup>1</sup> Peak Load current not to exceed 30 seconds with maximum 10% duty cycle.

<sup>2</sup> Requires at least 300 LFM of airflow.

<sup>3</sup> At 25 °C including factory setpoint, Line voltage and Load current variations.

<sup>4</sup> Peak to peak ripple measured at the output terminals with 10µF tantalum capacitor in parallel with 0.1µF ceramic capacitor across the output & at 25 °C and output load ≥ 6W.

## WORLDWIDE OFFICES

**Americas**

2900 S.Diablo Way  
Tempe, AZ 85282  
USA  
+1 888 412 7832

**Europe (UK)**

Waterfront Business Park  
Merry Hill, Dudley  
West Midlands, DY5 1LX  
United Kingdom  
+44 (0) 1384 842 211

**Asia (HK)**

14/F, Lu Plaza  
2 Wing Yip Street  
Kwun Tong, Kowloon  
Hong Kong  
+852 2176 3333

**ARTESYN**<sup>TM</sup>  
EMBEDDED TECHNOLOGIES

[www.artesyn.com](http://www.artesyn.com)

Artesyn Embedded Technologies, Artesyn and the Artesyn Embedded Technologies logo are trademarks and service marks of Artesyn Embedded Technologies, Inc. All other names and logos referred to are trade names, trademarks, or registered trademarks of their respective owners. © 2016 Artesyn Embedded Technologies, Inc. All rights reserved. For full legal terms and conditions, please visit [www.artesyn.com/legal](http://www.artesyn.com/legal).

For more information: [www.artesyn.com/power](http://www.artesyn.com/power)  
For support: [productsupport.ep@artesyn.com](mailto:productsupport.ep@artesyn.com)