

Ceramic, Commercial Grade, GoldMax, 0.022 uF, 10%, 50 V, X7R, Lead Spacing = 2.54mm

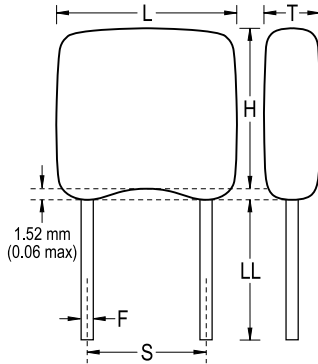

Dimensions

L	3.81mm MAX
H	3.14mm MAX
T	2.54mm MAX
S	2.54mm NOM
LL	7mm MIN
F	0.51mm NOM

Packaging Specifications

Packaging:	Bulk, Bag
Packaging Quantity:	500

General Information

Style:	Radial
Series:	GoldMax
Description:	GoldMax, Commercial Standard
RoHS:	Yes
Termination:	Tin
Failure Rate:	N/A

Specifications

Capacitance:	0.022 uF
Capacitance Tolerance:	10%
Voltage DC:	50 VDC
Temperature Range:	-55/+125C
Temperature Coefficient:	X7R
Dissipation Factor:	2.5%
Aging Rate:	3% Loss/Decade Hour
Insulation Resistance:	45.45 GOhms
Dielectric Strength:	125 V