

Printed-circuit board connector - DFMC 1,5/20-STF-3,5 - 1790470

Please be informed that the data shown in this PDF Document is generated from our Online Catalog. Please find the complete data in the user's documentation. Our General Terms of Use for Downloads are valid (<http://phoenixcontact.com/download>)

Plug, nominal current: 8 A, rated voltage (III/2): 160 V, number of positions: 20 with 40 contacts, pitch: 3.5 mm, connection method: spring-cage connection, color: green, contact surface: tin

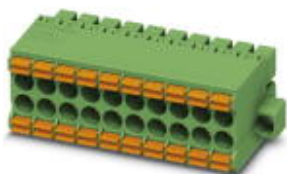

The figure shows a 10-pos. version with 20 contacts

Why buy this product

- Time saving push-in connection, tools not required
- Defined contact force ensures that contact remains stable over the long term
- Intuitive use through colour coded actuation lever
- Optimized for tight installation situations: operation and conductor connection from one direction
- Screwable flange for superior mechanical stability

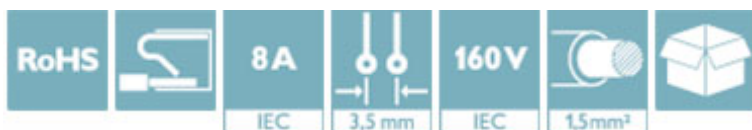

Key Commercial Data

Packing unit	50 STK
GTIN	 4 046356 594936
GTIN	4046356594936
Weight per Piece (excluding packing)	21.130 g
Custom tariff number	85366990
Country of origin	Germany

Technical data

Dimensions

Length	22.65 mm
Height	13.25 mm
Width	77 mm
Pitch	3.5 mm
Dimension a	66.5 mm

General

Range of articles	DFMC 1,5/..-STF
-------------------	-----------------

Printed-circuit board connector - DFMC 1,5/20-STF-3,5 - 1790470

Technical data

General

Type of contact	Female connector
Number of positions	20
Connection method	Push-in spring connection
Insulating material group	I
Rated surge voltage (III/3)	2.5 kV
Rated surge voltage (III/2)	2.5 kV
Rated surge voltage (II/2)	2.5 kV
Rated voltage (III/3)	160 V
Rated voltage (III/2)	160 V
Rated voltage (II/2)	250 V
Connection in acc. with standard	EN-VDE
Nominal current I _N	8 A
Nominal cross section	1.5 mm ²
Maximum load current	8 A
Insulating material	PA
Flammability rating according to UL 94	V0
Internal cylindrical gage	A1
Stripping length	10 mm

Connection data

Conductor cross section solid min.	0.2 mm ²
Conductor cross section solid max.	1.5 mm ²
Conductor cross section flexible min.	0.2 mm ²
Conductor cross section flexible max.	1.5 mm ²
Conductor cross section flexible, with ferrule without plastic sleeve min.	0.25 mm ²
Conductor cross section flexible, with ferrule without plastic sleeve max.	1.5 mm ²
Conductor cross section flexible, with ferrule with plastic sleeve min.	0.25 mm ²
Conductor cross section flexible, with ferrule with plastic sleeve max.	0.75 mm ²
Conductor cross section AWG min.	24
Conductor cross section AWG max.	16
Minimum AWG according to UL/CUL	16
Maximum AWG according to UL/CUL	24

Standards and Regulations

Connection in acc. with standard	EN-VDE
	CUL
Flammability rating according to UL 94	V0

Environmental Product Compliance

China RoHS	Environmentally friendly use period: unlimited = EFUP-e
	No hazardous substances above threshold values

Printed-circuit board connector - DFMC 1,5/20-STF-3,5 - 1790470

Drawings

Schematic diagram

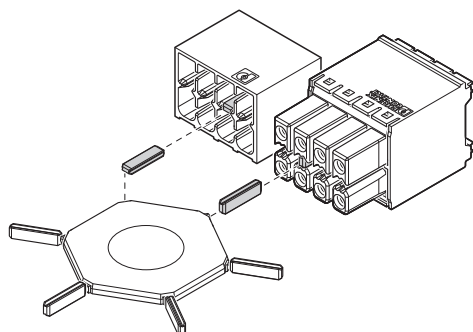

Diagram

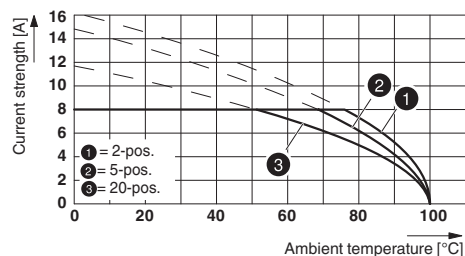

Use of the CP-DMC... coding profile

Dimensional drawing

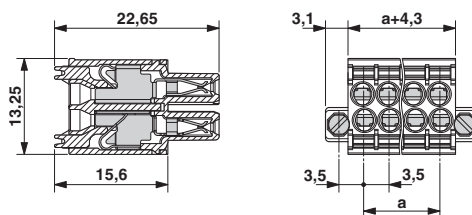

Classifications

eCl@ss

eCl@ss 4.0	272607xx
eCl@ss 4.1	27260701
eCl@ss 5.0	27260701
eCl@ss 5.1	27141190
eCl@ss 6.0	27260704
eCl@ss 7.0	27440402
eCl@ss 8.0	27440309
eCl@ss 9.0	27440309

ETIM

ETIM 4.0	EC002638
ETIM 5.0	EC002638
ETIM 6.0	EC002638

UNSPSC

UNSPSC 6.01	30211810
UNSPSC 7.0901	39121409

Printed-circuit board connector - DFMC 1,5/20-STF-3,5 - 1790470

Classifications

UNSPSC

UNSPSC 11	39121409
UNSPSC 12.01	39121409
UNSPSC 13.2	39121409

Approvals

Approvals

Approvals

VDE Gutachten mit Fertigungsüberwachung / IECEE CB Scheme / cULus Recognized / EAC

Ex Approvals

Approval details

VDE Gutachten mit Fertigungsüberwachung		http://www.vde.com/en/Institute/OnlineService/VDE-approved-products/Pages/Online-Search.aspx	40038423
mm ² /AWG/kcmil	0.2-1.5		
Nominal current IN	8 A		
Nominal voltage UN	160 V		

IECEE CB Scheme		http://www.iecee.org/	DE1-56070_B1_B2
Nominal current IN	8 A		
Nominal voltage UN	160 V		

cULus Recognized		http://database.ul.com/cgi-bin/XYV/template/LISEXT/1FRAME/index.htm	E60425-19920306
	B	C	
mm ² /AWG/kcmil	16-24	16-24	
Nominal current IN	8 A	8 A	
Nominal voltage UN	150 V	50 V	

Printed-circuit board connector - DFMC 1,5/20-STF-3,5 - 1790470

Approvals

EAC		B.01742
-----	--	---------

Accessories

Accessories

Coding element

Coding profile - CP-DMC 1,5 NAT - 1790647



Coding profile, for insertion between the coding ribs of the connector and the header following the reflow soldering process, insulating material, color: natural

Crimping tool

Crimping pliers - CRIMPFOX 6 - 1212034



Crimping pliers, for ferrules without insulating collar according to DIN 46228 Part 1 and ferrules with insulating collar according to DIN 46228 Part 4, 0.25 mm² ... 6.0 mm², lateral entry, trapezoidal crimp

Screwdriver tools

Screwdriver - SZS 0,4X2,5 VDE - 1205037



Screwdriver, slot-headed, VDE insulated, size: 0.4 x 2.5 x 80 mm, 2-component grip, with non-slip grip

Additional products

Printed-circuit board connector - DMC 1,5/20-G1F-3,5-LR P20THR - 1787195



Header, Nominal current: 8 A, Rated voltage (III/2): 160 V, Number of positions: 20, Pitch: 3.5 mm, Color: black, Contact surface: Tin, Mounting: THR soldering

Printed-circuit board connector - DFMC 1,5/20-STF-3,5 - 1790470

Accessories

Printed-circuit board connector - DMCV 1,5/20-G1F-3,5-LR P20THR - 1787577

Header, Nominal current: 8 A, Rated voltage (III/2): 160 V, Number of positions: 20, Pitch: 3.5 mm, Color: black, Contact surface: Tin, Mounting: THR soldering



Phoenix Contact 2016 © - all rights reserved
<http://www.phoenixcontact.com>