

Flush-type connector - SACC-CI-M12MS-4P SMD T - 1411924

Please be informed that the data shown in this PDF Document is generated from our Online Catalog. Please find the complete data in the user's documentation. Our General Terms of Use for Downloads are valid (<http://phoenixcontact.com/download>)



Flush-type connector, 4-position, PlugLink:straightLink:M12, A - standard, PCB mounting, SMD

Why buy this product

- Reduced mounting costs thanks to two-piece device connector
- Packaging available for automated pick and place assembly
- All common pin assignments and codings available
- Easy device integration thanks to mechanical port screw connections with threaded attachment, press-in contour or direct integration in the front plate
- Optional shield connection and seal for the device when not plugged in

Key Commercial Data

Packing unit	60 STK
Minimum order quantity	60 STK
GTIN	 4 046356 990028
GTIN	4046356990028
Weight per Piece (excluding packing)	3.880 g
Custom tariff number	85366990
Country of origin	Germany
Note	Made to Order (non-returnable)

Technical data

Ambient conditions

Ambient temperature (operation)	-55 °C ... 105 °C (Plug / socket)
	-55 °C ... 105 °C (without mechanical actuation)
Degree of protection	IP67 (correctly plugged in and locked)

General

Note	The electrical and mechanical data specified assume that the connector pair is correctly locked and mounted. If the connector is unlocked and if
------	--

Flush-type connector - SACC-CI-M12MS-4P SMD T - 1411924

Technical data

General

	there is a danger of contamination, the connector must be sealed using a protective cap > IP54. Influences arising from litz wires, cables or PCB assembly must also be taken into consideration.
Rated current at 40°C	4 A
Rated voltage	250 V
Rated surge voltage	2.5 kV
Number of positions	4
Insulation resistance	≥ 100 MΩ
Coding	A - standard
Standards/regulations	M12 connector IEC 61076-2-101 In line with
Overvoltage category	II
Degree of pollution	3
Connection method	SMD
Insertion/withdrawal cycles	> 100
Mounting type	PCB mounting
Type of packaging	Tray
Delivery state	with assembly pad

Material

Flammability rating according to UL 94	V0
Contact material	CuZn
Contact surface material	Au
Contact carrier material	PA

Cable

Standards/specifications	M12 connector IEC 61076-2-101 In line with
--------------------------	--

Standards and Regulations

Standard designation	M12 connector
Standards/regulations	IEC 61076-2-101
Flammability rating according to UL 94	V0

Environmental Product Compliance

China RoHS	Environmentally Friendly Use Period = 50
	For details about hazardous substances go to tab "Downloads", Category "Manufacturer's declaration"

Drawings

Flush-type connector - SACC-CI-M12MS-4P SMD T - 1411924

Schematic diagram

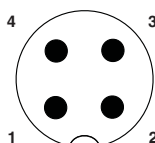

Pin assignment M12 plug, 4-pos., A-coded, view plug side

Drilling diagram

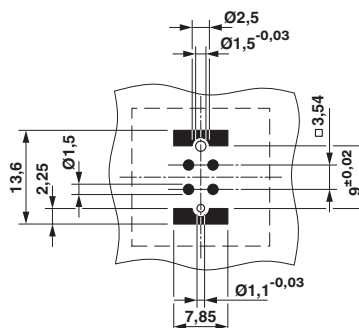

Soldering pad geometry

Dimensional drawing

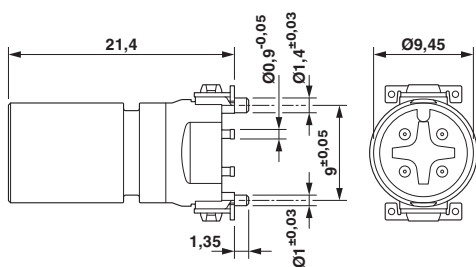

Dimensional drawing

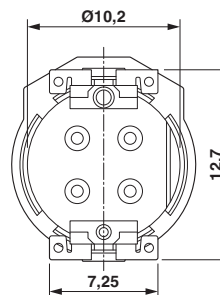

M12 male connector contact carrier

View of solder side

Dimensional drawing

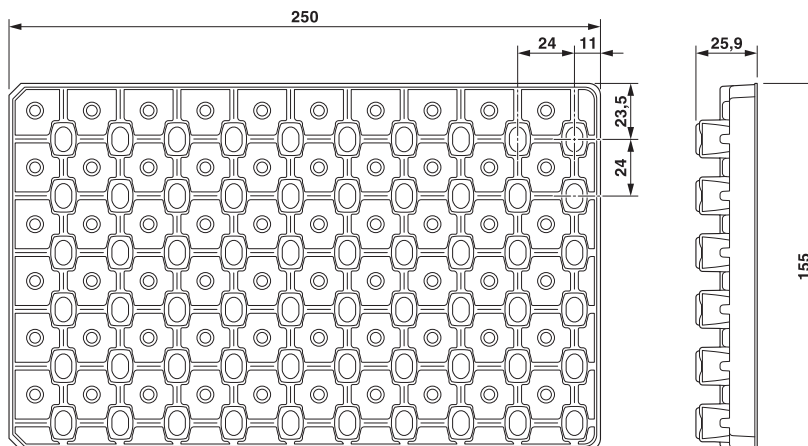

SMD tray packaging

Flush-type connector - SACC-CI-M12MS-4P SMD T - 1411924

Classifications

eCl@ss

eCl@ss 5.1	27143423
eCl@ss 6.0	27143423
eCl@ss 8.0	27440103
eCl@ss 9.0	27440102

ETIM

ETIM 5.0	EC002061
ETIM 6.0	EC002061

UNSPSC

UNSPSC 13.2	39121413
-------------	----------

Approvals

Approvals

Approvals

EAC / cULus Recognized

Ex Approvals

Approval details

EAC		B.01742
-----	---	---------

cULus Recognized		http://database.ul.com/cgi-bin/XYV/template/LISEXT/1FRAME/index.htm E221474-20160506
Nominal current IN	4 A	
Nominal voltage UN	250 V	

Accessories

Accessories

Panel mounting base

Flush-type connector - SACC-CI-M12MS-4P SMD T - 1411924

Accessories

Housing screw connection - SACC-BP-M-M12/M15-6-SMD - 1414000



Housing screw connection, PlugLink:M12, Rear mounting, M15 x 1

Housing screw connection - SACC-BP-M-M12/M15-6-SMD SCO - 1414002



Housing screw connection, PlugLink:M12-SPEEDCON, Rear mounting, M15 x 1

Housing screw connection - SACC-FP-M-M12/M14 SMD - 1412078



Housing screw connection, PlugLink:M12, Front mounting, M14 x 1

Housing screw connection - SACC-FP-M-M12/PRESS SMD - 1412080



Housing screw connection, pin, for the two-part M12 SMD connector, for press-in mounting.
