

Ferrule - AI-TWIN 2X10 -14 RD - 3201026

Please be informed that the data shown in this PDF Document is generated from our Online Catalog. Please find the complete data in the user's documentation. Our General Terms of Use for Downloads are valid (<http://phoenixcontact.com/download>)



Ferrule, Sleeve length: 14 mm, Length: 26 mm, Color: red

Why buy this product

- ✓ Different versions of the individual TWIN ferrules can be selected for specific applications
- ✓ The TWIN ferrules provide a practical way of crimping two conductors in one ferrule
- ✓ These special ferrules allow chain bridges to be set up with ease



Key Commercial Data

Packing unit	100 STK
Minimum order quantity	100 STK
GTIN	 4 017918 094577
GTIN	4017918094577
Weight per Piece (excluding packing)	0.960 g
Custom tariff number	85369010
Country of origin	Germany

Technical data

Dimensions

Length (b)	26 mm
Maximum stripping length	19 mm
Sleeve length	14 mm
Inner dimension of the insulating collar (d)	7.2 mm
Ferrule diameter	6.5 mm
Insulating collar thickness	0.4 mm
Sleeve wall thickness	0.2 mm

Ambient conditions

Short-term temperature	120 °C
------------------------	--------

Ferrule - AI-TWIN 2X10 -14 RD - 3201026

Technical data

Ambient conditions

Max. permanent temperature	105 °C
----------------------------	--------

General

Color	red
Components	free from silicone and halogen
Flammability rating according to UL 94	HB
Material	E-CU
Coating	tin-plated (galvanic)

Standards and Regulations

Connection in acc. with standard	CSA
Flammability rating according to UL 94	HB

Environmental Product Compliance

China RoHS	Environmentally friendly use period: unlimited = EFUP-e
	No hazardous substances above threshold values

Drawings

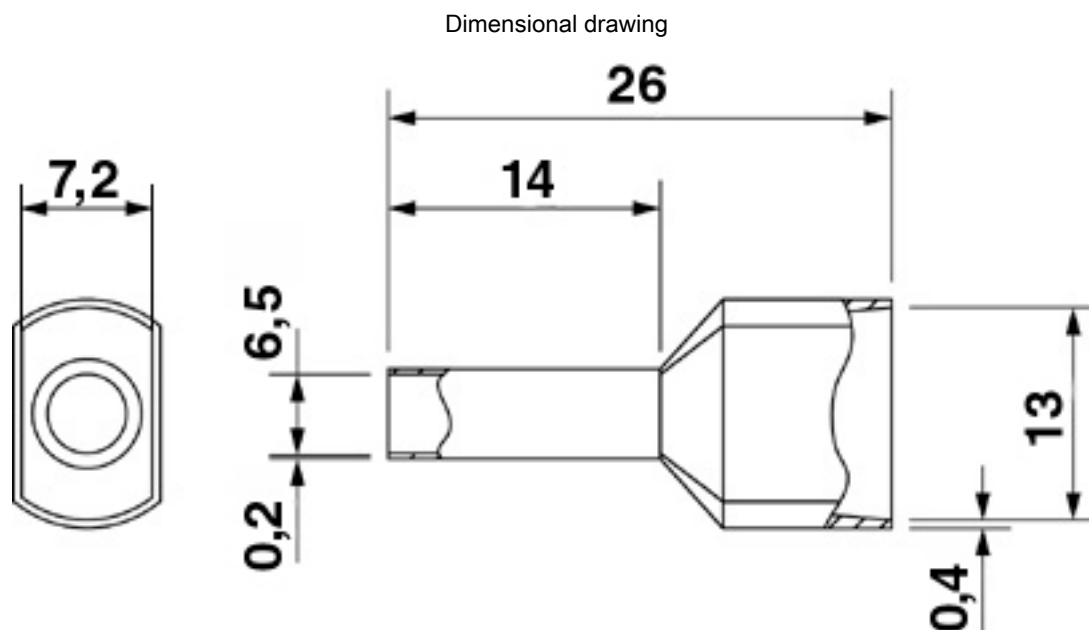

Classifications

eCl@ss

eCl@ss 4.0	27060701
eCl@ss 4.1	27060701
eCl@ss 5.0	27400201
eCl@ss 5.1	27400201

Ferrule - AI-TWIN 2X10 -14 RD - 3201026

Classifications

eCl@ss

eCl@ss 6.0	27400201
eCl@ss 7.0	27400201
eCl@ss 8.0	27400201
eCl@ss 9.0	27400201

ETIM

ETIM 2.0	EC000005
ETIM 3.0	EC000005
ETIM 4.0	EC000005
ETIM 5.0	EC000005
ETIM 6.0	EC000005

UNSPSC

UNSPSC 6.01	30212109
UNSPSC 7.0901	27121703
UNSPSC 11	27121703
UNSPSC 12.01	27121703
UNSPSC 13.2	27121703

Approvals

Approvals

Approvals

CSA / CSAus / EAC / EAC / UL Listed / cUL Listed / cCSAus

Ex Approvals

Approval details

CSA		http://www.csagroup.org/services/testing-and-certification/certified-product-listing/	247397
-----	---	---	--------

CSAus		http://www.csagroup.org/services/testing-and-certification/certified-product-listing/	247397
-------	---	---	--------

Ferrule - AI-TWIN 2X10 -14 RD - 3201026

Approvals

EAC		EAC-Zulassung
-----	---	---------------

EAC		7500651.22.01.00246
-----	---	---------------------

UL Listed		http://database.ul.com/cgi-bin/XYV/template/LISEXT/1FRAME/index.htm	E488001
-----------	---	---	---------

cUL Listed		http://database.ul.com/cgi-bin/XYV/template/LISEXT/1FRAME/index.htm	E488001
------------	---	---	---------

cCSAus		http://www.csagroup.org/services/testing-and-certification/certified-product-listing/
--------	---	---