

Features

Unregulated Converters

- +20/-5V & +15/-3V Asymmetric Outputs for SiC Driver Applications
- +15/-9V Asymmetric Outputs for IGBT Driver Applications
- Pot-Core Transformer with separated windings
- High 6.4kVDC Isolation in compact SIP8 size
- Low isolation capacitance (10pF max.)
- Optional Continuous Short Circuit Protected
- UL and EN (pending)

Description

High slew rate SiC transistor drivers require an isolated asymmetric supply of +20/-5V or +15/-3V with high isolation voltage and low isolation capacitance. The RxxPxyyD series have been specially designed to fulfill this demanding requirement with 6400VDC isolation and <10pF isolation capacitance. The DC/DC converters can be used with equal power (1W + 1W) or equal current (1.6W + 0.4W) driver applications as the dual outputs feature automatic power sharing. The internal transformer uses a pot-core to physically separate the input and output windings, yet the converter still fits into an industry standard SIP8 case. Input voltage options of 5, 12, 15 or 24V are available and the RxxPxyyD series is safety certified to the latest UL/IEC62368 standard (certification pending).

Selection Guide

Part Number	Input Voltage [VDC]	Output Voltage [VDC]	Output Current [mA]	Efficiency typ. [%]	max. Capacitive Load ⁽¹⁾ [μF]
R12P21503D	12	+15/-3	+93/-185	84	150/680
R15P21503D	15	+15/-3	+93/-185	81	150/680
R24P21503D	24	+15/-3	+93/-185	82	150/680
R05P21509D	5	+15/-9	+67/-111	70	±330
R12P21509D	12	+15/-9	+67/-111	80	±330
R24P21509D	24	+15/-9	+67/-111	82	±330
R05P22005D	5	+20/-5	50/-200 +/-80	82 83	47/680
R12P22005D	12	+20/-5	50/-200 +/-80	82	47/680
R15P22005D	15	+20/-5	50/-200 +/-80	83 84	47/680
R24P22005D	24	+20/-5	50/-200 +/-80	84 85	47/680

Notes:

Note1: Max. capacitive load is tested at nominal input voltage and full load.

Model Numbering

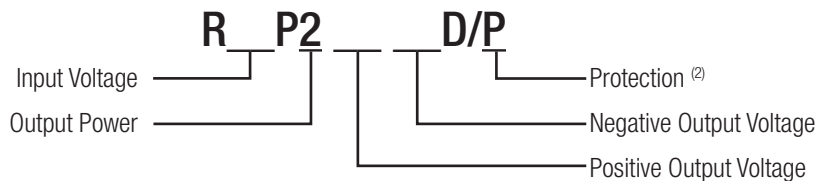

Notes:

Note2: add suffix "/P" for continuous short circuit protection (not available for RxxP21503D) without suffix no short circuit protection

RECOM
DC/DC Converter

RxxP2xyyD

2 Watt
SIP7 for
SiC and IGBT
Application's

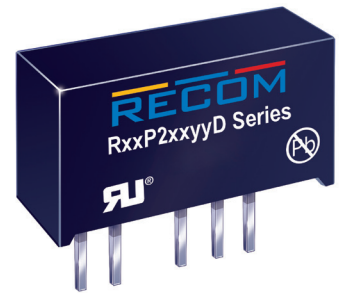

C **RU** US
E358085



IEC/EN60950-1 (pending)
UL60950-1 (pending)
CSA C22.2 60950-1-03 (pending)
IEC/EN62368-1 (pending)
UL62368-1 (pending)
CAN No. 62368-1-14 (pending)
CB Report

Specifications (measured @ $t_a = 25^\circ\text{C}$, nominal Input and full load after warm-up time unless otherwise noted)

Parameter	Condition		Min.	Typ.	Max.
Internal Input Filter			Capacitor		
Input Voltage Range	nom. Vin=	5Vin	4.5VDC		5.5VDC
		12Vin	10.8VDC		13.2VDC
		15Vin	13.5VDC		16.5VDC
		24Vin	21.6VDC		26.4VDC
Start-up Time				5ms	
Internal Operating Frequency			20kHz	50kHz	
Minimum Load			0%		
Output Ripple and Noise	20MHz bandwidth				200mVp-p

Efficiency vs. Load

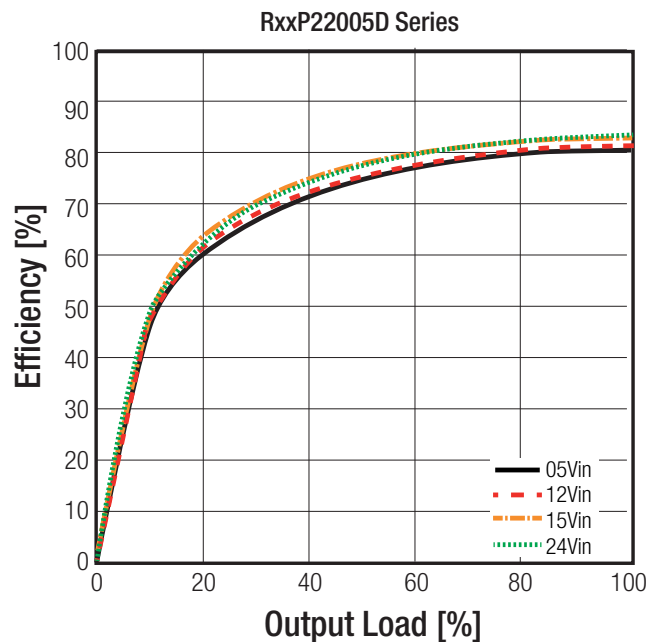
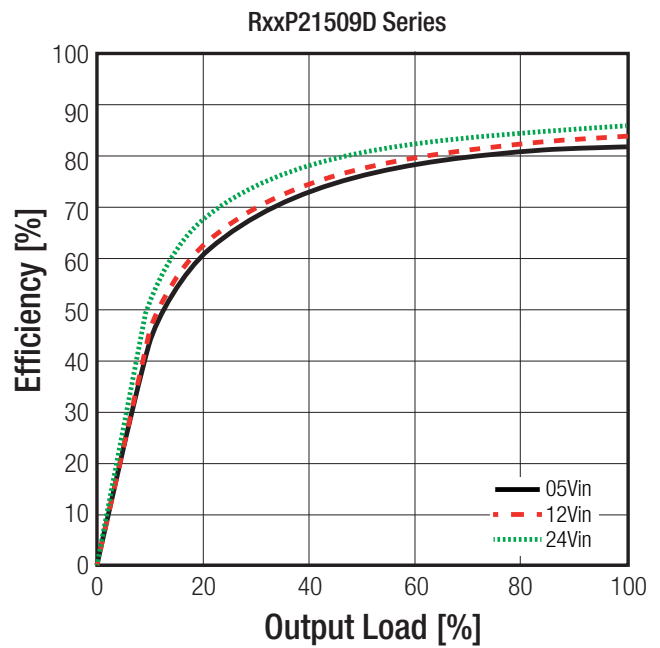
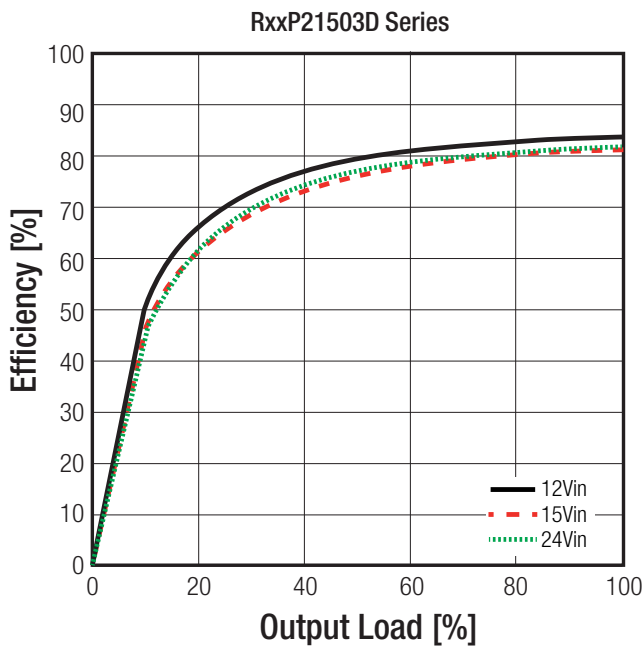

Specifications (measured @ $t_a = 25^\circ\text{C}$, nominal Input and full load after warm-up time unless otherwise noted)

REGULATIONS		
Parameter	Condition	Values
Output Accuracy		$\pm 5.0\%$ max.
Line Regulation	low line to high line	1.2% of 1% V_{in} typ.
Load Regulation	10% to 100% load	10.0% max.

Tolerance Envelope

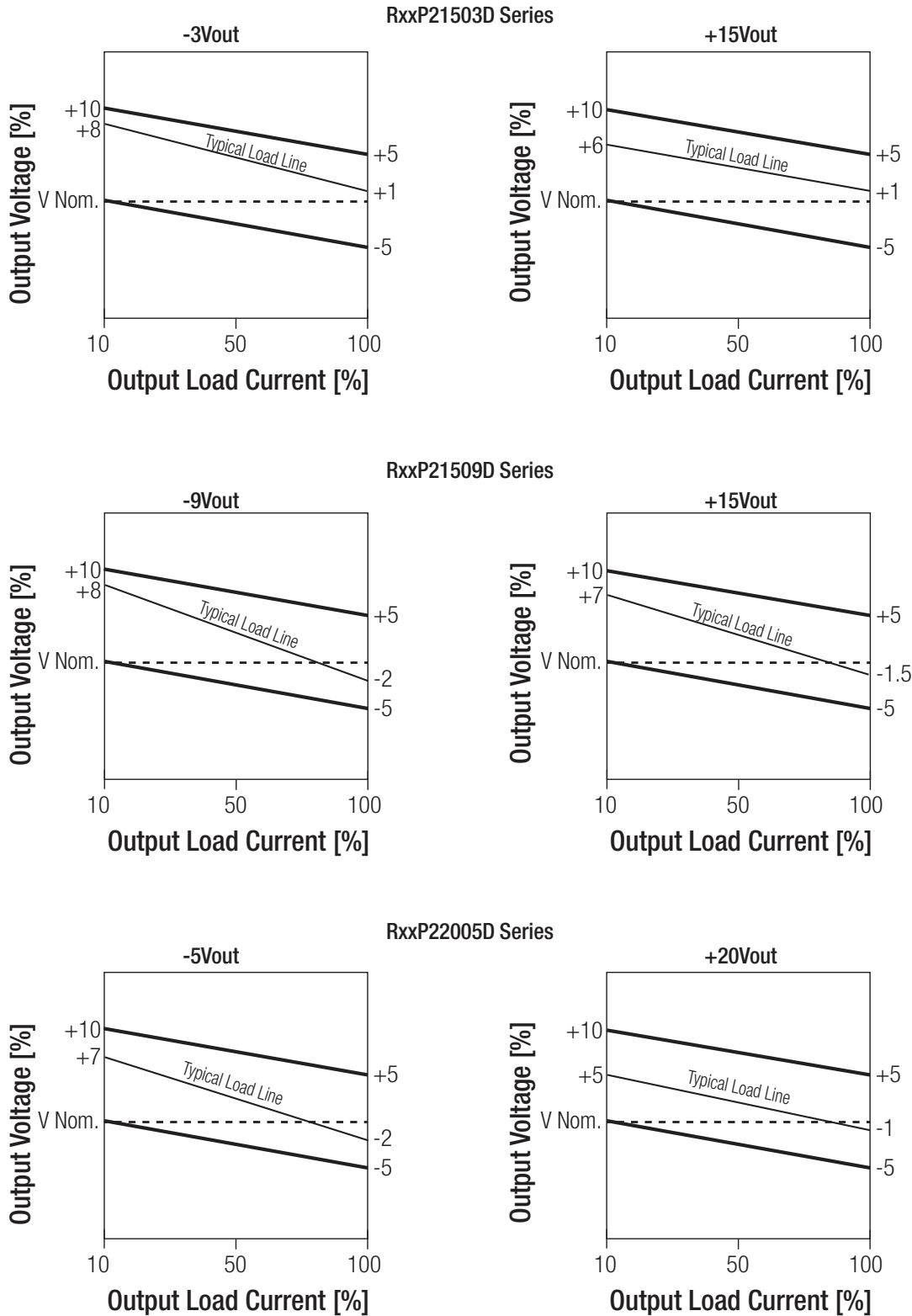

Specifications (measured @ $t_a = 25^\circ\text{C}$, nominal Input and full load after warm-up time unless otherwise noted)

PROTECTIONS			
Parameter	Condition		Value
Short Circuit Protection	RxxP21509D RxxP22005D	only with suffix "/P"	continuous, automatic recovery
Isolation Voltage ⁽²⁾	I/P to O/P	tested for 1 second tested for 1 minute tested for 1 minute	6.4kVDC 5.2kVDC 3kVAC
Isolation Capacitance			3pF typ. / 10pF max.
Isolation Resistance			15GΩ min.
Insulation Grade			basic
Notes: Note2: For repeat Hi-Pot testing, reduce the time and/or the test voltage.			

ENVIRONMENTAL			
Parameter	Condition		Value
Operating Temperature Range	without derating		-40°C to +90°C
	with derating		-40°C to +95°C
Maximum Case Temperature			105°C max.
Temperature Coefficient			±0.02%/°C
Thermal Impedance			30°C/W
Operating Humidity	non-condensing		5-95% RH max.
Vibration			accordind to MIL-STD-202G
Pollution Degree			PD2
MTBF	according to MIL-HDBK-217F, G.B.	+25°C	14600 x 10 ³ hours
		+90°C	4000 x 10 ³ hours

Derating Graph

(@ Chamber and natural convection 0.1m/s)

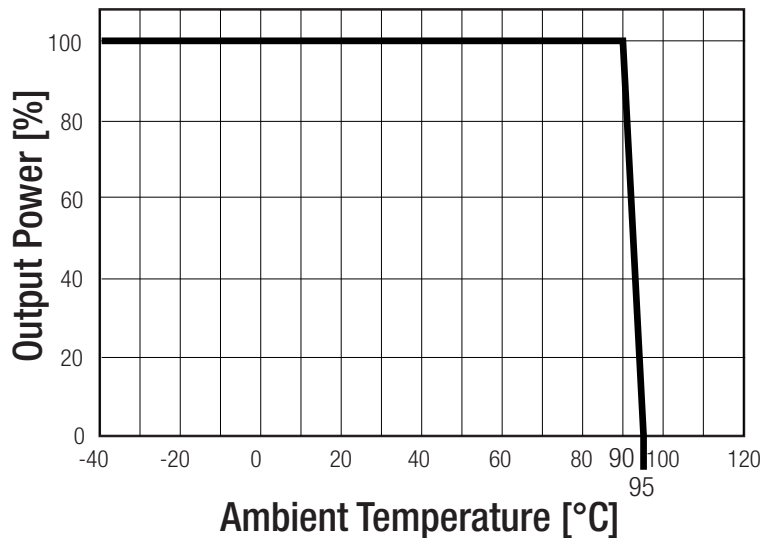

Specifications (measured @ ta= 25°C, nominal Input and full load after warm-up time unless otherwise noted)

SAFETY AND CERTIFICATIONS

Certificate Type	Report / File Number	Standard
Information Technology Equipment, General Requirements for Safety	pending	UL60950-1, 2nd Edition, 2007 CSA C22.2 No. 60950-1-03, 2nd Edition, 2007
Information Technology Equipment, General Requirements for Safety (LVD)	pending	EN60950-1, 2nd Edition 2006, +A2:2013 IEC60950-1, 2nd Edition 2005 + A2:2013
Audio/Video, information and communication technology equipment - Part1: Safety requirements (CB Scheme)	pending	IEC62368-1, 2nd Edition 2014
Audio/Video, information and communication technology equipment - Part1: Safety requirements	pending	IEC62368-1, 2nd Edition 2014 EN62368-1, 2nd Edition 2014
Audio/Video, information and communication technology equipment - Part1: Safety requirements	pending	UL62368-1, 2nd Edition 2014 CSA CAN No. 62368-1-14, 2014
RoHs 2+		RoHS 10/10, 2011/65/EU + AM-2015/863

EMI Compliance	Condition	Standard / Criterion
Information technology equipment - Radio disturbance characteristics - Limits and methods of measurement	with external components (see filter suggestions)	EN55022, Class B

EMC Filtering according to EN55022

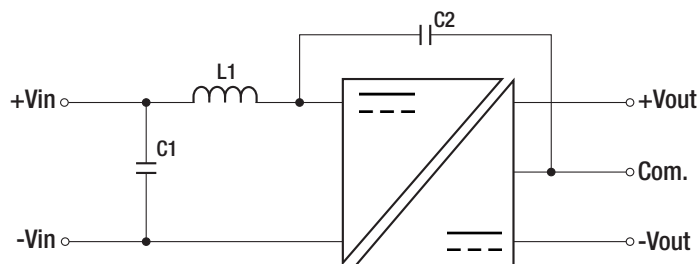

Component List Class B

Series	Vin	C1	L1	C2 ⁽³⁾
RxxP21503D	12VDC	2.2µF	47µH Choke	470pF 6kVDC
	15VDC			
	24VDC			
RxxP21509D	12VDC	10µF	10µH Choke	
	15VDC	4.7µF	22µH Choke	
	24VDC	2.2µF	47µH Choke	
RxxP22005D	5VDC	10µF	10µH Choke	
	12VDC	4.7µF	22µH Choke	
	15VDC			
	24VDC	2.2µF	47µH Choke	

Notes:

Note3: For SiC or IGBT application's, don't use C2 to decrease system isolation capacitance. Adapt primary filter according specific application.

DIMENSION and PHYSICAL CHARACTERISTICS

Parameter	Type	Value
Material	Case	plastic, (UL94V-0)
	Potting	silicone, (UL94V-0)
	PCB	FR4, (UL94V-0)
Package Dimension (LxWxH)		19.5 x 9.8 x 12.5mm
Package Weight		4.3g typ.

continued on next page

Specifications (measured @ $t_a = 25^\circ\text{C}$, nominal Input and full load after warm-up time unless otherwise noted)

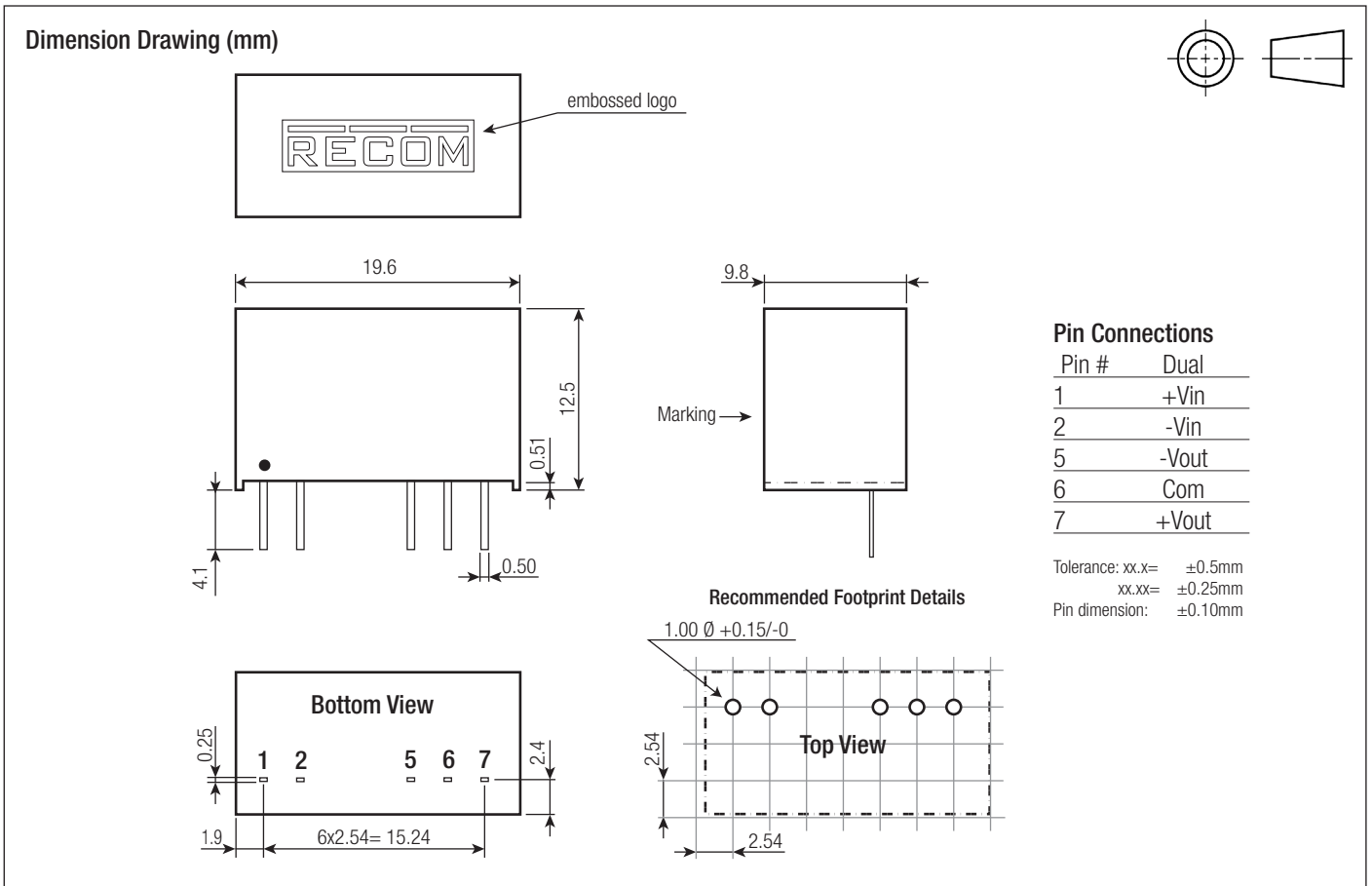

INSTALLATION AND APPLICATION

Typical Application Circuit

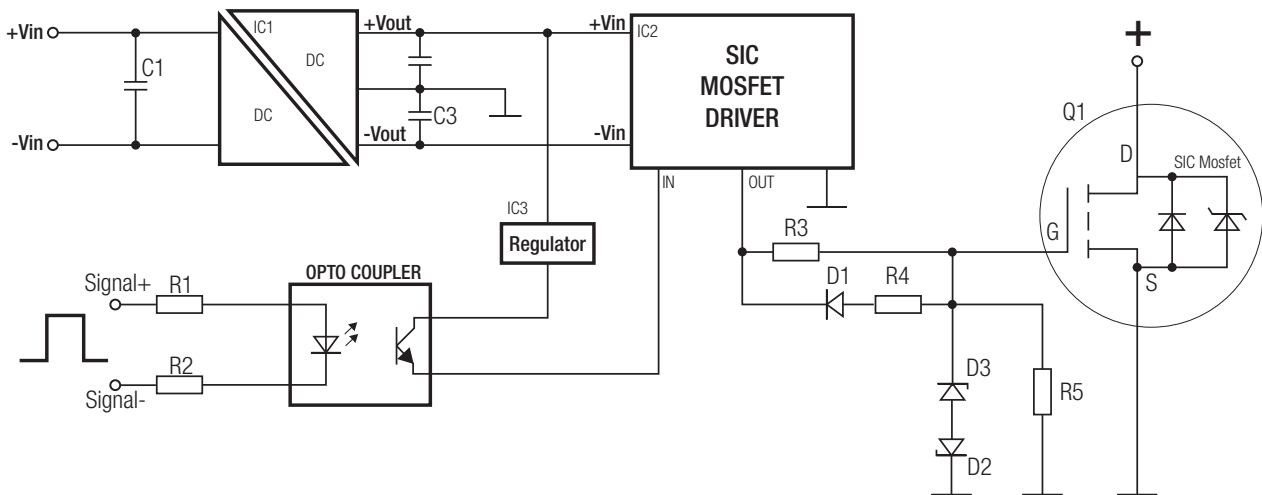

PACKAGING INFORMATION

Packaging Dimension (LxWxH)	Tube	520.0 x 22.3 x 12.0mm
Packaging Quantity		25pcs
Storage Temperature Range		-55°C to +125°C
Storage Humidity		5-95% RH max.

The product information and specifications are subject to change without prior notice. RECOM products are not authorized for use in safety-critical applications (such as life support) without RECOM's explicit written consent. A safety-critical application is defined as an application where a failure of a RECOM product may reasonably be expected to endanger or cause loss of life, inflict bodily harm or damage property. The buyer shall indemnify and hold harmless RECOM, its affiliated companies and its representatives against any damage claims in connection with the unauthorized use of RECOM products in such safety-critical applications.