

## DU-35J & DU-35K

### Thermocouple Temperature Meter 3 1/2 Digit with 0.56" LEDs in a 1/8 DIN Case

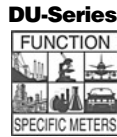

#### Economical J or K Thermocouple Temperature Meters pre-calibrated °C or °F.

#### General Features

The DU-35J and DU-35K are economical thermocouple input temperature meters with a resolution of 1°. They are ordered, pre-calibrated for either °F or °C indication. Automatic cold junction compensation, Thermocouple Break Detection, Display Hold and Display Test functions are provided as standard features.

#### Typical Application Connections

##### Temperature Measurement with J Thermocouple

1°C or 1°F Resolution

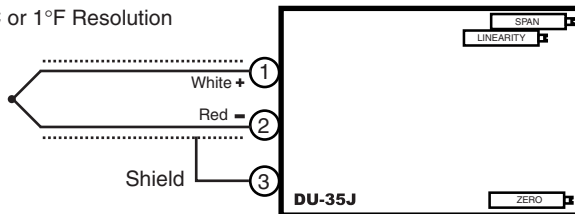

Grounded or Ungrounded thermocouples may be used.

##### Temperature Measurement with K Thermocouple

1°C or 1°F Resolution

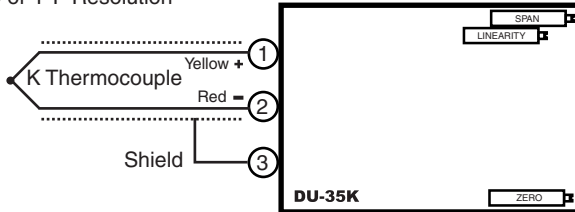

Grounded or Ungrounded thermocouples may be used.

#### Compatibility

The DU-Series have a matching DIN case style that is complementary to the Lynx, Leopard and Tiger family of meters. DU-Meters are the OEM's choice for economical switchboard and process indication. For economy, each model is dedicated to a specific application and designed for quick and easy installation.



#### Specifications

Input Configuration: .....Differential

Full Scale Ranges:.....DU-35JC 0 to 760°C  
DU-35JF 0 to 1400°F  
DU-35KC 0 to 1260°C  
DU-35KF 0 to 1999°F

Lead Resistance Effects: ..20µV per 10Ω of lead resistance

Cold Junction

Compensation:.....Automatic ±0.1°C/°C (Cal. @25°C)

Input Protection: .....25V AC/DC

A/D Converter: .....12 Bit Dual Slope

Conformity Error

(at 25°C):.....DU-35JC ±(2°C + 1 digit) typical  
DU-35JF ±(4°F + 1 digit) maximum  
DU-35KC ±(3°C + 1 digit) typical  
DU-35KF ±(5°F + 1 digit) maximum

Temperature Coefficient: ..100ppm/°C (Typical)

Warm Up Time:.....One minute to specified accuracy

Conversion Rate: .....3 readings per second

Display: .....0.56" hi efficiency Red or optional Green LEDs. Display Hold & Display Test are provided.

Polarity:.....Bipolar. Assumed positive, displays negative

Decimal Selection:.....Header under face plate, X•X•X•X•

Overrange/ Open

Thermocouple Indication: Most significant "1" digit is displayed with all other digits blank

Power Supply (std): .....120/240V AC, 50/60 Hz. approx 2.5W.

(Optn) VO-DC/ISO .....Isolated Switcher. 9 to 36V DC/12 to 24V AC

(Optn) VO-24V .....Isolated Transformer 24V AC ±10%

(Optn) VO-5V DC.....Non-isolated 5V DC ±10%

Operating Temperature: ....-10 to 50 °C

Storage Temperature: .....-20 to 70 °C

Relative Humidity: .....95% (non-condensing)

Case Dimensions:.....1/8 DIN, Bezel: 96x48mm (3.78"x1.89")  
Depth behind bezel 117 mm (4.61") plus 11.8mm (0.47") for Right-angled Connector or 20mm (0.79") for Straight-through Connectors.

Weight:.....11 oz., 14 oz when packed

#### DU-Series, the OEMs choice for switchboard and process indication

DU-35AC1/5 .....AC amps, Scaled RMS. (1 or 5 Amp Internal shunt), 3.5 digit  
DU-35ACIRMS1/5 .....AC amps, True RMS. (1 or 5 Amp Internal shunt), 3.5 digit  
DU-40AC1-5 .....AC amps, Scaled RMS. (1 or 5 Amp Internal shunt), 4 digit  
DU-35AC .....AC volts, Scaled RMS. 199.9/700V AC Header Selectable Ranges, 3.5 digit  
DU-35ACRMS .....AC volts, True RMS 199.9/700V AC Header Selectable Ranges, 3.5 digit  
DU-40AC .....AC volts, Scaled RMS. 700.0V AC full scale, 4 digit  
DU-35HZ .....15.0Hz to 199.9Hz or 15/500Hz. Up to 700V AC input, 3.5 digit  
DU-35 .....DC volts ±2V/±20V/±200V Header Selectable Ranges, 3.5 digit  
DU-35MV .....DC mV ±50mV, ±100mV, ±200mV Header Selectable Ranges, 3.5 digit

DU-45 .....DC volts ±2V/±20V/±200V Header Selectable Ranges, 4.5 digit  
DU-45MV .....DC mV ±50mV/±100mV/±200mV Header Selectable Ranges, 4.5 digit  
DU-35CL .....Process 4 to 20mA (100.0), easily user scalable, 3.5 digit  
DU-35CLE .....Process 4 to 20mA (100.0) with 24V DC excitation, scalable, 3.5 digit  
DU-45CL .....Process 4 to 20mA (100.00), easily user scalable, 4.5 digit  
DU-35P .....Pressure, strain gage and load cell, 4 and 6 wire, 5V DC excitation, Header Selectable Sensitivity 2mV/V, 5mV/V, 10mV/V, 20mV/V, 3.5 digit  
DU-35J/K .....Order J or K Thermocouple and °C or °F, 3.5 digit  
DU-35RTD .....100Ω platinum RTD, 3 or 4 wire, order °C or °F and 0.1° or 1°, 3.5 digit

## Functional Diagram

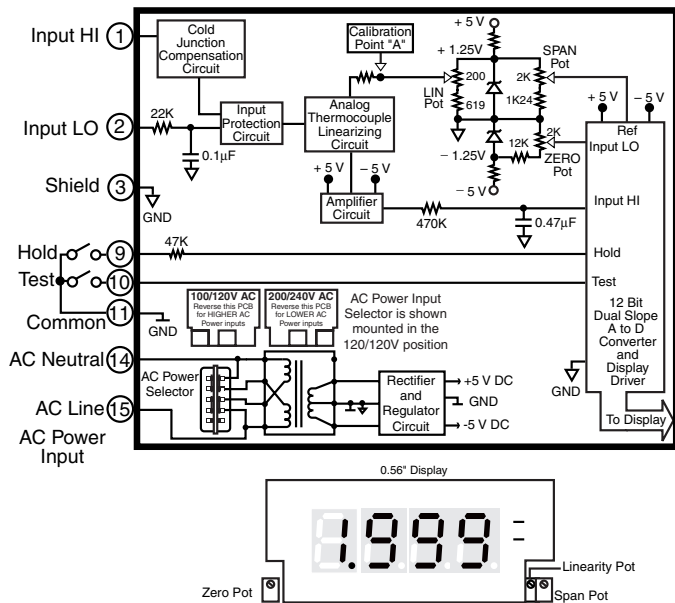

## Connector Pinouts

This meter is supplied with plug-in type screw terminal connectors. The power supply pins (14 & 15) have a unique plug and socket outline to prevent cross connection. (see DU Connectors)

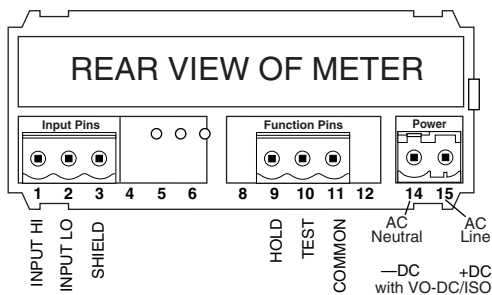

**WARNING:** AC and DC input signals and power supply voltages can be hazardous. Do Not connect live wires to screw terminal plugs, and do not insert, remove or handle screw terminal plugs with live wires connected.

**Pin 1 - Thermocouple Positive Input:** The thermocouple positive output is applied to these pins (refer to Table 2 for color codes). Maximum overvoltage protection is 25V AC/DC.

**Pin 2 - Thermocouple Negative Input:** The thermocouple negative output is applied to these pins (refer to Table 2 for color codes). Maximum overvoltage protection is 25V AC/DC.

**Pin 3 - Shield:** This pin is internally connected to the ground of the internal power supply.

**Pin 9 - Hold Reading:** If this Pin is left unconnected, the meter will operate in a free-running mode. When this pin is connected to the Hold/Test Common Pin 11, the meter will latch up. A/D conversions will continue, but the display will not be updated until Pin 9 is disconnected from the Hold/Test Common pin 11.

**Pin 10 - Display Test:** All numeric display segments will light up when this pin is connected to the Hold/Test Common Pin 11.

**Pin 11 - Hold/Test Common:** The Hold and Display Test Pins have to be connected to this pin to activate their respective functions.

**Pins 14 & 15 - AC Power Input:** These pins are the Power Input pins for the meter. All DU-Series meters sold in North America are pre-configured at the factory for 100/120V AC operation. To reconfigure for 200/240V AC operation, simply pull out the AC Power Voltage Selector located directly behind the transformer, turn it around and reinsert it into the socket so that "200/240V AC" is visible. Various other AC/DC power options are available. See Ordering Information for details.

## Component Layout

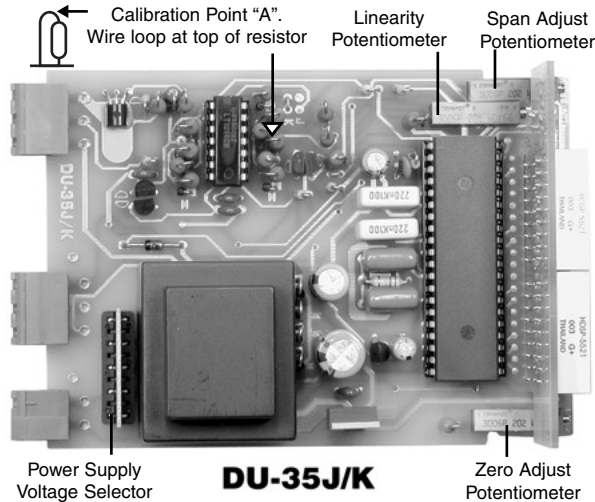

## Signal Conditioning Components

### SPAN SPAN Potentiometer (Pot)

To the Right Front Turn Clockwise to Increase Reading  
The 15 turn SPAN pot is always on the right side (as viewed from the front of the meter). Typical adjustment is 20% of the input signal range.

### ZERO ZERO Potentiometer (Pot)

To the Left Front Turn Clockwise to Increase Reading  
The ZERO pot is to the left of the SPAN pot (viewed from the front of the meter). Typically it enables the input signal to be offset  $\pm 5\%$  of full scale.

### LINEARITY LINEARITY Potentiometer (Pot)

To the Right Front Use to set voltage at Calibration Point "A"  
The LINEARITY pot is used to set the voltage at the calibration Point "A". The Linearity Pot is adjusted at the factory and does not normally need to be re-adjusted by the user.

## Calibration Procedure

1. Connect a J or K Thermocouple Simulator to the input of the appropriate model and calibrate according to the Calibration Table. If your simulator does not output the specific values shown in the Table, then set the simulator to the next nearest value and make the calibration adjustments to that value instead of the values in the Table.
2. LINEARITY. The LINEARITY Pot is calibrated at the factory and does not normally need to be re-calibrated by the user. If Linearity must be re-calibrated, connect a voltmeter between the shield and calibration Point "A" (shown on the component layout), then follow step 3.

### Calibration Table

| DU - model no.   | DU-35JF | DU-35JC | DU-35KF | DU-35KC |
|--|---------|---------|---------|---------|
| <b>Thermocouple Type</b><br>Can not be changed   | J       | J       | K       | K       |
| <b>Temperature Scale</b><br>Re-calibrate to change °F/°C   | °F      | °C      | °F      | °C      |
| 3. Adjust Linearity Pot until the voltage at calibration Point "A" is exactly 1.000V with the simulator output set to: | 1400°F  | 760°C   | 1990°F  | 1260°F  |
| 4. Adjust Zero Pot so display matches TC simulator with output set to:   | 0°F     | 0°C     | 0°F     | 0°C     |
| 5. Adjust Span Pot so display matches TC simulator with output set to:   | 1400°F  | 760°C   | 1990°F  | 1260°F  |

6. The J meter is now calibrated and ready for use.

## Opening Back Panel



To open back panel, insert a flat screwdriver or similar instrument in both slots on the top of the case and pry open. The DU-Series meters slide out from the rear of the case as a complete assembly.

## Selecting Power Supply Voltage

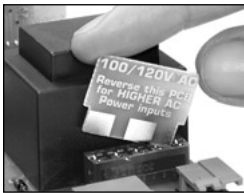

This unique voltage selector PCB displays the operating voltage selected. To change the voltage, disconnect power to the meter. Remove the selector, reverse the selector and fully re-insert it in the socket. This selector is not required for optional power supplies.

## DU-Series Connector Options

### Plug-in Screw Terminal Connectors are Provided

#### Input Power Screw Terminal Plug

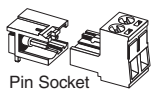

Part Number:  
93-PLUG2P-DP

#### Right-angled Screw Terminal Plug

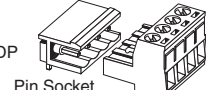

Part Numbers:  
93-PLUG2P-DR.....2 pins  
93-PLUG3P-DR.....3 pins  
93-PLUG4P-DR.....4 pins  
93-PLUG5P-DR.....5 pins  
93-PLUG6P-DR.....6 pins

Spade Lug pinouts and insulated quick disconnects may still be ordered as an option. P/N.:CN-SPADE.

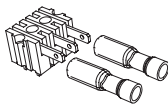

## Metal Surround Case Option

The meter's plastic case is made from fire retardant polycarbonate. A metal surround case can be ordered to enhance the meter's fire retardant capabilities and also provide shielding against electromagnetic interference (EMI). The metal case slides over the polycarbonate case and is held firmly in place by spring-type non-return clips. The Metal Surround Case must be factory installed on the polycarbonate case and once installed, it cannot be removed in the field.

With the metal case in place, the meter's standard ratchet-type mounting clips can not be used. Instead a pair of screw-type DIN standard mounting clips are provided, which clip into holes on the side of the metal case and tighten against the rear of the panel. A ground tab on the metal case enables the metal case to be easily connected to the panel ground.

Part No.  
OP-MTL96X48

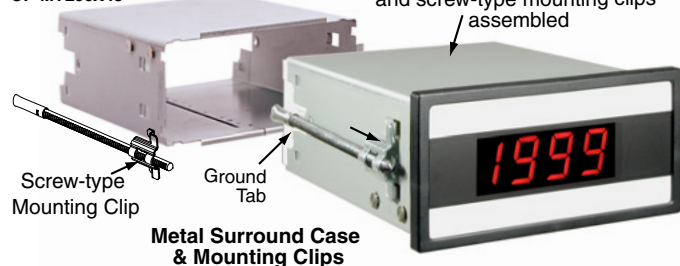

## Face Plate Descriptors

|     |       |                   |       |                    |                    |       |
|-----|-------|-------------------|-------|--------------------|--------------------|-------|
| AC  | Ω     | kV                | kVAR  | m <sup>3</sup> /hr | Hz                 | RPM   |
| V   | mV    | min               | PF    | °F                 | °C                 | Cosθ  |
| DC  | x10kN | μA                | PSIG  | mS                 | kg/cm <sup>2</sup> | psi   |
| KW  | W     | kWH               | pH    | %                  | K                  | kPa   |
| A   | mbar  | mA                | MW    | kA                 | RPS                | MWH   |
| mWs | μm    | kW/s              | I     | l/sec              | ml                 | cm    |
| ORP | mm/s  | 1/min             | mm    | kg/sec             | lbs                | kg/hr |
| FT  | bars  | min <sup>-1</sup> | m/min | Mvars              | μV                 | dB    |

To customize the face plate, each DU-meter is supplied with a white printed clear adhesive label containing various popular descriptors. Choose the descriptor desired, peel off the adhesive backing and align the descriptor in the center right of the faceplate.

## Custom Face Plates



### Texmate Produces Thousands of Custom OEM Face Plates

Have Texmate Design and Build a Custom Face Plate to Suit your Next project!

- Custom face plates have a non-recurring artwork charge. A serial number is then assigned to each artwork, to facilitate re-ordering.

- Small Run or One-Off custom face plates incur an installation charge, and are generally printed on a special plastic film, which is then laminated to custom faceplate blanks as required.
- Large Run (250 pieces min): custom face plates are production silk screened, issued a part number, and held in stock for free installation as required by customer orders.
- OEMs may also order Custom Meter Labels, Box Labels Custom Data Sheets and Instruction Manuals.

## Optional Display Styles



DU Series Above-Center Display Option



0.8" LED Options available in Lynx Family

To match all display styles, DU-Meters have an optional display and faceplate with the digits positioned above center. (see Display Options)

For 0.8" LEDs in 1/8 DIN cases order Lynx family DX-35 and DX-40 w/ LR or LG displays and input modules that match DU-Series inputs.

## Clear Lockable Water-proof Cover

The clear lockable cover is designed to be dust and water proof to NEMA-4X, IP65 standards. The assembly consists of a base and cover with a cam hinge and key-lock fastening mechanism. An O-ring, or neoprene gasket forms a seal between the base and the panel. The cam hinge prevents the cover from closing when opened until pushed closed. The cover has a tapered recess that, when closed, forms a seal with a tapered spigot on the base. A key-lock employs a cam locking device to force the spigot into the recess, ensuring seal integrity. A safety catch keeps the cover closed even when the key is removed, and the keyhole can be used to attach a safety seal clip, preventing unauthorized opening.

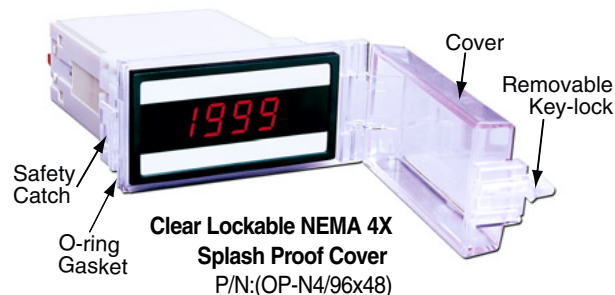

# DU Case Dimensions and Panel Cutouts

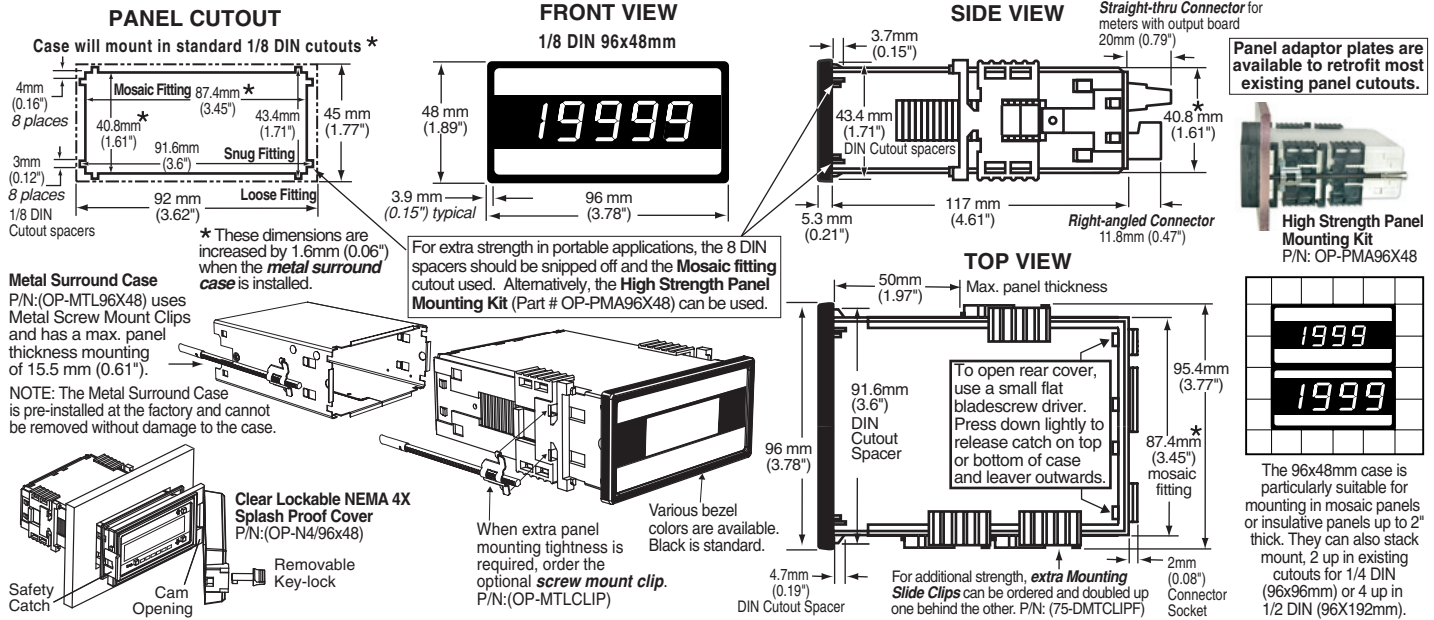

## Ordering Information

### Standard Options for this Model Number

| Part Number   | Description  |
|---|--|
| <b>► BASIC MODEL NUMBER</b> Includes plug in type screw terminals, standard display and standard power supply unless optional versions are ordered. |  |
| DU-35JF   | .....DPM, J thermocouple in °F                             |
| DU-35JC   | .....DPM, J thermocouple in °C                             |
| DU-35KF   | .....DPM, K thermocouple in °F                             |
| DU-35KC   | .....DPM, K thermocouple in °C                             |
| <b>► DISPLAY</b>  |  |
| <b>STANDARD</b> .....Red LEDs, 0.56 inch high   |  |
| DU-BRIGHT   | .....Super bright Red LEDs, 0.56 inch high                 |
| DU-GREEN  | .....Green LEDs, 0.56 inch high                            |
| DU-GREEN 4.5D   | .....Dummy Zero Display Option w/ Green LEDs               |
| DU-RED4.5D  | .....Dummy Zero Display Option w/ Green LEDs               |
| DU-35HI/BRT   | .....Above center position, .56 inch, Bright Red LED       |
| DU-35HI/GRN   | .....Above center position, .56 inch, Green LED            |
| DU-35HI/RED   | .....Above center position, .56 inch, Red LED              |
| <b>► POWER SUPPLY</b>   |  |
| <b>STANDARD</b> .....100/120 or 200/240VAC User selectable  |  |
| V0-DC/ISO   | .....Isolated auto-sensing AC/DC 9 to 36 VDC/12 to 24 VAC  |
| V0-24V  | .....Isolated transformer 12 VAC or 24 VAC user selectable |
| V0-5V   | .....Non-Isolated 5V DC only                               |

### Special Options and Accessories

| Part Number   | Description  |
|---|--|
| <b>► ACCESSORIES (Specify Serial # for Custom Artwork Installation)</b> |  |
| 75-DBBZ9648F  | .....Black Bezel for 96x48mm Case                                  |
| 75-DMTCLIPP   | .....Side Slide Brackets (2 pc) - extra set, extra strength        |
| 76-DU35G  | .....Replacement DU Series grey lens for Green LEDs                |
| 76-DU35R  | .....Replacement DU Series red lens for Red LEDs                   |
| 76-DUPPP/N  | .....Anti-glare protective front lens plate for DU Series          |
| 93-PLUG2P-DP  | .....Extra Screw Terminal Conn., 2 Pin Power Plug                  |
| 93-PLUG3P-DR  | .....Extra Screw Terminal Conn., 3 Pin Plug                        |
| DN-SPADE  | .....Spade Lug pinouts and Insulated quick disconnects             |
| DN-CAS96X48A  | .....Complete 96x48mm Case with bezel                              |
| OP-DUXTDP   | .....Option for External Decimal Point                             |
| OP-MCLP96X48  | .....Screw Mounting Clips (2 pc) to screw tighten slide brackets   |
| OP-MTL96X48   | .....Metal Surround Case includes metal mounting clips             |
| OP-N4X/96X48  | .....Clear Lockable Water-proof cover, Nema 4X, IP65               |
| QD-KIT-1  | .....Replacement Crimp-on Quick Disconnects (7 per Set)            |
| ART-FS-S/D  | .....NRC for Artwork & set-up Custom Faceplate and/or Descriptor   |
| ART-FS-S/D/C  | .....NRC for Artwork & set-up Custom Faceplate and Custom Logo     |
| ART-FS-001  | .....Produce & Install Custom Faceplate per meter - 1 color no-min |
| ART-FS-002  | .....Produce & Install Custom Faceplate per meter - 2 color no-min |
| ART-FS-003  | .....Produce & Install Custom Faceplate per meter - 3 color no-min |
| ART-FL-001  | .....Custom Faceplate, 250 piece Min. - 1 color                    |
| ART-FL-002  | .....Custom Faceplate, 250 piece Min. - 2 color                    |
| ART-FL-003  | .....Custom Faceplate, 250 piece Min. - 3 color                    |

Many other options and accessories are available. See full price list for more details. Prices subject to change without notice.

### WARRANTY

Texmate warrants that its products are free from defects in material and workmanship under normal use and service for a period of one year from date of shipment. Texmate's obligations under this warranty are limited to replacement or repair, at its option, at its factory, of any of the products which shall, within the applicable period after shipment, be returned to Texmate's facility, transportation charges pre-paid, and which are, after examination, disclosed to the satisfaction of Texmate to be thus defective. The warranty shall not apply to any equipment which shall have been repaired or altered, except by Texmate, or which shall have been subjected to misuse, negligence, or accident. In no case shall Texmate's liability exceed the original purchase price. The aforementioned provisions do not extend the original warranty period of any product which has been either repaired or replaced by Texmate.

### USER'S RESPONSIBILITY

We are pleased to offer suggestions on the use of our various products either by way of printed matter or through direct contact with our sales/application engineering staff. However, since we have no control over the use of our products once they are shipped, NO WARRANTY WHETHER OF MERCHANTABILITY, FITNESS FOR PURPOSE, OR OTHERWISE is made beyond the repair, replacement, or refund of purchase price at the sole discretion of Texmate. Users shall determine the suitability of the product for the intended application before using, and the users assume all risk and liability whatsoever in connection therewith, regardless of any of our suggestions or statements as to application or construction. In no event shall Texmate's liability, in law or otherwise, be in excess of the purchase price of the product.

Texmate cannot assume responsibility for any circuitry described. No circuit patent or software licenses are implied. Texmate reserves the right to change circuitry, operating software, specifications, and prices without notice at any time.



995 Park Center Drive • Vista, CA 92081-8397

Tel: 1-760-598-9899 • USA 1-800-839-6283 • That's 1-800-TEXMATE

Fax: 1-760-598-9828 • Email: sales@texmate.com • Web: www.texmate.com

Texmate has facilities in Japan, New Zealand, Taiwan, and Thailand. We also have authorized distributors throughout the USA and in 28 other countries.

For product details visit [www.texmate.com](http://www.texmate.com)

Local Distributor Address