

# T591/T598 High Humidity/High Temperature Automotive Grade Polymer Electrolytic, 2.5 – 50 VDC

## Overview

The KEMET Organic Capacitor (KO-CAP) is a solid electrolytic capacitor with a conductive polymer cathode capable of delivering very low ESR and improved capacitance retention at high frequencies. KO-CAP combines the low ESR of multilayer ceramic, the high capacitance of aluminum electrolytic and the volumetric efficiency of tantalum into a single surface mount package. Unlike liquid electrolyte-based capacitors, KO-CAP has a very long operational life and high ripple current capabilities.

## KOCAP Polymer Capacitors

The T591/T598 High Humidity/High Temperature Polymer Electrolytic Series delivers higher capacitance and ESR stability under harsh environmental conditions. Enhancements to the design and selected material upgrades were introduced to deliver 500 hours (T591) or 1,000 hours (T598) at 85°C/85% RH rated voltage and to fully comply with the AEC-Q200 Qualification Testing. These series are manufactured in an ISO TS 16949 certified plant and are subjected to PPAP/PSW and change control.

## Benefits

- Ultra-low ESR
- Full compliance with AEC-Q200 Qualification Test Plan (T598)
- Qualification plan based on AEC-Q200 with 85°C/85% RH load specification limited to 500 hours (T591)
- TS 16949 certified plant
- Subject to PPAP/PSW and Change Control
- Meets or exceeds EIA standard 535BAAC
- Taped and reeled per EIA 481
- Halogen-free epoxy/RoHS compliant

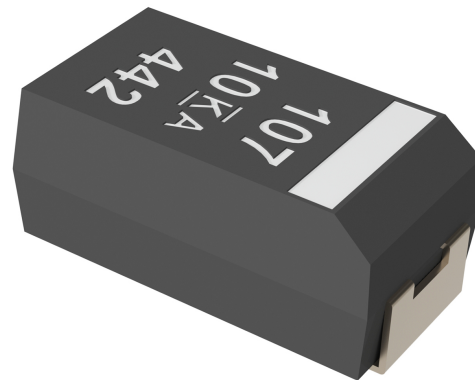

## Applications

Typical applications include decoupling and filtering in a variety of market segments, with special emphasis in automotive applications such as infotainment and input/output in DC/DC converters where harsh conditions such as high humidity and temperature are a concern.

## Environmental Compliance

RoHS Compliant (6/6) according to Directive 2002/95/EC when ordered with 100% Sn solder. Halogen-free.

## K-SIM

For a detailed analysis of specific part numbers, please visit [ksim.kemet.com](http://ksim.kemet.com) to access KEMET’s K-SIM software. KEMET K-SIM is designed to simulate behavior of components with respect to frequency, ambient temperature, and DC bias levels.

## Ordering Information

T	59X	D	107	M	010	A	T	E025
Capacitor Class	Series	Case Size	Capacitance Code (pF)	Capacitance Tolerance	Rated Voltage (VDC)	Failure Rate/ Design	Termination Finish	ESR
T = Tantalum	591 = 500 Hours Load Humidity 598 = AEC-Q200 Qualified	B D V X	First two digits represent significant figures. Third digit specifies number of zeros.	M = ±20%	2R5 = 2.5 006 = 6.3 010 = 10 016 = 16 020 = 20 025 = 25 035 = 35 050 = 50	A = N/A	T = 100% Tin (Sn)	Maximum ESR in mΩ, 025 = 25 mΩ

## Performance Characteristics

Item	Performance Characteristics
Operating Temperature	-55°C to 105°C/125°C
Rated Capacitance Range	10 – 330 µF at 120 Hz/25°C
Capacitance Tolerance	M Tolerance (20%)
Rated Voltage Range	2.5 – 50 V
DF (120 Hz)	Refer to Part Number Electrical Specification Table
ESR (100 kHz)	Refer to Part Number Electrical Specification Table
Leakage Current	≤ 0.1 CV (µA) at rated voltage after 5 minutes

## Qualification

Test	Condition	Characteristics				
Endurance	105°C at rated voltage, 2,000 hours 125°C at 2/3 rated voltage, 1,000 hours**	Δ C/C	Within -20%/+10% of initial value			
		DF	Within 2 x Initial Limits			
		DCL	Within 2 x Initial Limit			
		ESR	Within 2 x Initial Limit			
Storage Life	105°C at 0 volts, 2,000 hours 125°C at 0 volts, 1,000 hours**	Δ C/C	Within -20%/+10% of initial value			
		DF	Within 2 x Initial Limits			
		DCL	Within 2 x Initial Limit			
		ESR	Within 2 x Initial Limit			
Humidity	85°C, 85% RH, Load, 500 hours (T591) 85°C, 85% RH, Load, 1,000 hours (T598)	Δ C/C	Within -5%/+35% of initial value			
		DF	Within 1.5 x Initial Limits			
		DCL	Within Initial Limit			
		ESR	Within 2 x Initial Limit			
Moisture Resistance*	MIL-STD-202, Method 106, 65°C, 90-100% RH, No Load, 10 cycles	Δ C/C	Within -10%/+20% of initial value			
		DF	Within Initial Limits			
		DCL	Within Initial Limit			
		ESR	Within 2 x Initial Limits			
Thermal Shock	MIL-STD-202, Method 107, Condition B, mounted, -55°C to +105°C/+125°C**, 1,000 cycles	Δ C/C	Within -20%/+10% of initial value			
		DF	Within Initial Limits			
		DCL	Within Initial Limit			
		ESR	Within 2 x Initial Limits			
Surge Voltage	105°C, 1.32 x rated voltage, 1,000 cycles, 33 Ω in series 125°C, 1.32 x (0.67 x V <sub>R</sub> ), 1,000 cycles, 33 Ω in series**	Δ C/C	Within -20%/+10% of initial value			
		DF	Within initial limits			
		DCL	Within initial limits			
		ESR	Within initial limits			
Temperature Stability	Extreme temperature exposure at a succession of continuous steps at +25°C, -55°C, +25°C, +85°C, +105°C/+125°C**, +25°C	Δ C/C	+25°C	-55°C	+85°C	+105°C/+125°C**
		DF	IL***	±20%	±20%	±30%
		DCL	IL	IL	1.2 x IL	1.5 x IL
Mechanical Shock/ Vibration	AEC-Q200 (MIL-STD-202, Method 213, Figure 1, Condition F)	Δ C/C	Within ±10% of initial value			
		DF	Within initial limits			
	AEC-Q200 (MIL-STD-202, Method 204, 5 g for 20 min/12 cycles each of 3 orientations. Test from 10 – 2, 000 Hz).	ESR	Within initial limits			
		DCL	Within initial limits			

\* T598 only

\*\* Refer to part number specifications for individual temperature classification

\*\*\* IL = Initial Limit

## Certification

KEMET's Internal Qualification Plan for this polymer electrolytic series of capacitors follows AEC-Q200 guidelines. For T591 the humidity bias is limited to a maximum of 500 hours. For T598 the qualification plan is full compliant with AEC-Q200.

## Electrical Characteristics

ESR vs. Frequency – T591

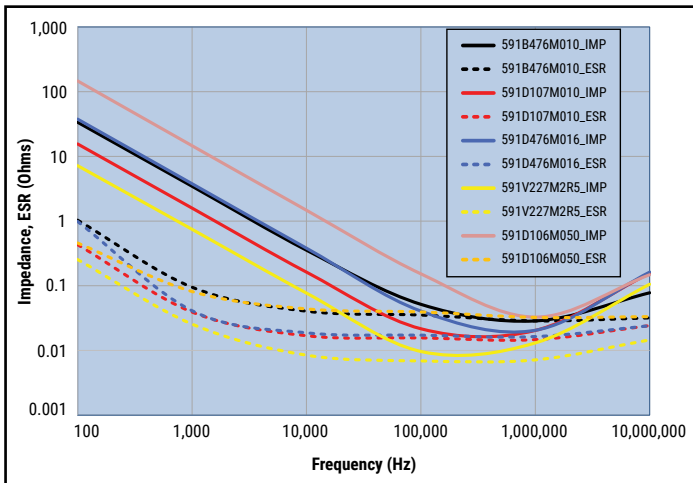

Capacitance vs. Frequency – T591

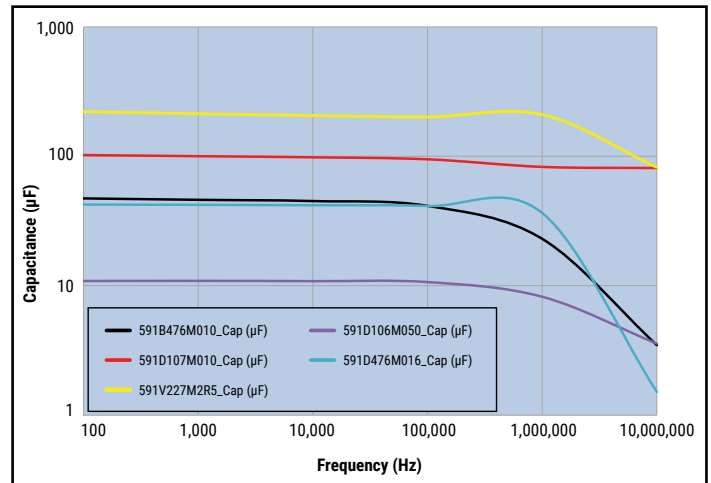

ESR vs. Frequency – T598

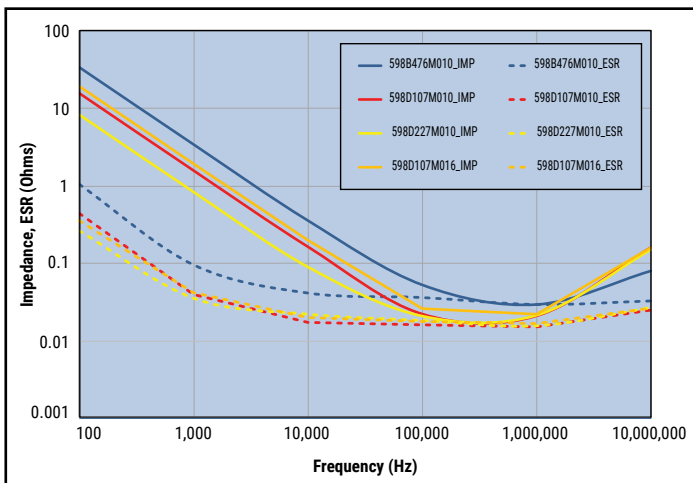

Capacitance vs. Frequency – T598

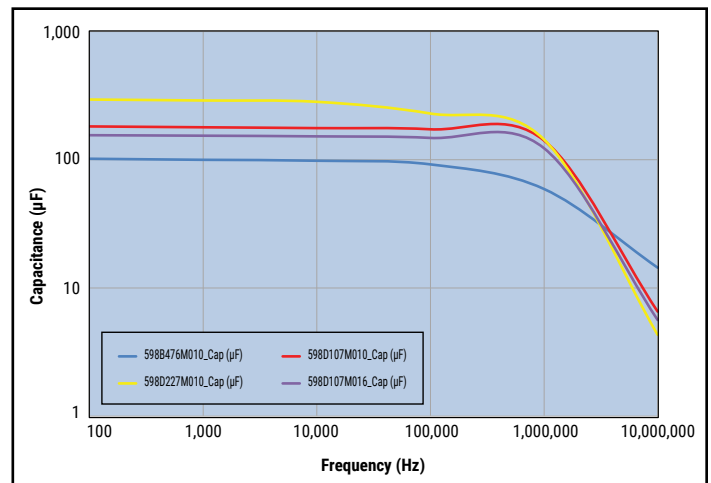

## Dimensions – Millimeters (Inches)

Metric will govern

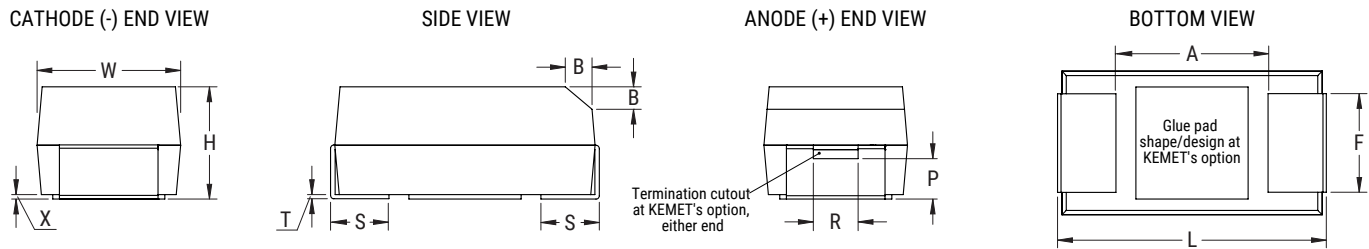

Case Size		Component Dimensions											Total Weight
KEMET	EIA	L	W	H	F ±0.1 ±(0.004)	S ±0.3 ±(0.012)	B ±0.15 (Ref) ±0.006	X (Ref)	P (Ref)	R (Ref)	T (Ref)	A (Minimum)	(mg)
B	3528-21	3.5±0.2 (0.138±0.008)	2.8±0.2 (0.110±0.008)	1.9±0.2 (0.075±0.008)	2.2 (0.087)	0.8 (0.031)	0.4 (0.016)	0.10±0.10 (0.004±0.004)	0.5 (0.020)	1.0 (0.039)	0.13 (0.005)	1.1 (0.043)	95
D	7343-31	7.3±0.3 (0.287±0.012)	4.3±0.3 (0.169±0.012)	2.8±0.3 (0.110±0.012)	2.4 (0.094)	1.3 (0.051)	0.5 (0.020)	0.10±0.10 (0.004±0.004)	0.9 (0.035)	1.0 (0.039)	0.13 (0.005)	3.8 (0.150)	435
V	7343-20	7.3±0.3 (0.287±0.012)	4.3±0.3 (0.169±0.012)	1.9±0.1 (0.075±0.004)	2.4 (0.094)	1.3 (0.051)	N/A	0.05 (0.002)	N/A	0.13 (0.005)	3.8 (0.150)	3.8 (0.150)	274
X	7343-43	7.3±0.3 (0.287±0.012)	4.3±0.3 (0.169±0.012)	4.0±0.3 (0.157±0.012)	2.4 (0.094)	1.3 (0.051)	0.5 (0.020)	0.10±0.10 (0.004±0.004)	1.7 (0.067)	0.13 (0.005)	3.6 (0.142)	3.8 (0.150)	554

Notes: (Ref) – Dimensions provided for reference only. For low profile cases, no dimensions are provided for B, P or R because these cases do not have a bevel or a notch.

These weights are provided as reference. If exact weights are needed, please contact your KEMET Sales Representative

**Table 1 – Ratings & Part Number Reference**

Rated Voltage	Rated Cap	Case Code/ Case Size	KEMET Part Number	DC Leakage	DF	ESR	Maximum Allowable Ripple Current	MSL	Maximum Operating Temp	AEC-Q200 Qualified
VDC at 105°C	µF	KEMET/EIA		µA at +25°C Max/5 Minutes	% at +25°C 120 Hz Max	mΩ at +25°C 100 kHz Max	mA at +45°C 100 kHz	Reflow Temp ≤ 260°C	°C	T598 Only <sup>1</sup>
2.5	220	V/7343-20	T591V227M2R5ATE009	55	10	9	4558	3	105	
2.5	220	V/7343-20	T591V227M2R5ATE012	55	10	12	3947	3	105	
2.5	220	V/7343-20	T591V227M2R5ATE015	55	10	15	3531	3	105	
2.5	330	V/7343-20	T591V337M2R5ATE012	82.5	10	12	3947	3	105	
2.5	330	V/7343-20	T591V337M2R5ATE025	82.5	10	25	2735	3	105	
2.5	330	D/7343-31	T591D337M2R5ATE015	82.5	10	15	3873	3	105	
2.5	330	D/7343-31	T591D337M2R5ATE018	82.5	10	18	3536	3	105	
4	220	V/7343-20	T591V227M004ATE018	88	10	18	3223	3	105	
4	220	V/7343-20	T591V227M004ATE025	88	10	25	2735	3	105	
6.3	33	B/3528-21	T598B336M006ATE080	20.8	8	80	1260	3	125	•
6.3	33	B/3528-21	T591B336M006ATE080	20.8	8	80	1260	3	125	
6.3	47	B/3528-21	T598B476M006ATE070	29.6	8	70	1347	3	125	•
6.3	47	B/3528-21	T591B476M006ATE070	29.6	8	70	1347	3	125	
6.3	68	B/3528-21	T598B686M006ATE070	43	8	70	1347	3	125	•
6.3	68	B/3528-21	T591B686M006ATE070	43	8	70	1347	3	125	
6.3	150	V/7343-20	T591V157M006ATE025	94.5	10	25	2735	3	125	
6.3	150	V/7343-20	T591V157M006ATE045	94.5	10	45	2039	3	125	
6.3	150	D/7343-31	T598D157M006ATE025	94.5	10	25	3000	3	125	•
6.3	150	D/7343-31	T591D157M006ATE025	94.5	10	25	3000	3	125	
6.3	220	D/7343-31	T598D227M006ATE025	139	10	25	3000	3	125	•
6.3	220	D/7343-31	T591D227M006ATE025	139	10	25	3000	3	125	
6.3	330	D/7343-31	T598D337M006ATE025	208	10	25	3000	3	125	•
6.3	330	D/7343-31	T598D337M006ATE040	208	10	40	2372	3	125	•
6.3	330	D/7343-31	T598D337M006ATE080	208	10	80	1677	3	125	•
6.3	330	D/7343-31	T591D337M006ATE025	208	10	25	3000	3	125	
6.3	330	D/7343-31	T591D337M006ATE040	208	10	40	2372	3	125	
6.3	330	D/7343-31	T591D337M006ATE080	208	10	80	1677	3	125	
10	33	B/3528-21	T598B336M010ATE080	33	8	80	1260	3	125	•
10	33	B/3528-21	T591B336M010ATE080	33	8	80	1260	3	125	
10	47	B/3528-21	T598B476M010ATE070	47	8	70	1347	3	125	•
10	47	B/3528-21	T591B476M010ATE070	47	8	70	1347	3	125	
10	100	D/7343-31	T598D107M010ATE025	100	10	25	3000	3	125	•
10	100	D/7343-31	T591D107M010ATE025	100	10	25	3000	3	125	
10	100	D/7343-31	T598D107M010ATE040	100	10	40	2372	3	125	•
10	100	D/7343-31	T591D107M010ATE040	100	10	40	2372	3	125	
10	100	D/7343-31	T598D107M010ATE080	100	10	80	1677	3	125	•
10	100	D/7343-31	T591D107M010ATE080	100	10	80	1677	3	125	
10	100	D/7343-31	T591D107M010ATE040	100	10	40	2372	3	125	
10	100	D/7343-31	T591D107M010ATE080	100	10	80	1677	3	125	
10	100	V/7343-20	T591V107M010ATE025	100	10	25	2735	3	125	
10	100	V/7343-20	T591V107M010ATE045	100	10	45	2039	3	125	
10	220	D/7343-31	T598D227M010ATE025	220	10	25	3000	3	125	•
10	220	D/7343-31	T591D227M010ATE025	220	10	25	3000	3	125	
10	220	D/7343-31	T598D227M010ATE040	220	10	40	2372	3	125	•
10	220	D/7343-31	T591D227M010ATE040	220	10	40	2372	3	125	
10	220	D/7343-31	T598D227M010ATE080	220	10	80	1677	3	125	•
10	220	D/7343-31	T591D227M010ATE080	220	10	80	1677	3	125	
16	47	D/7343-31	T591D476M016ATE070	75.2	10	70	1793	3	125	
16	100	D/7343-31	T598D107M016ATE050	160	10	50	2121	3	125	•
16	100	D/7343-31	T591D107M016ATE050	160	10	50	2121	3	125	
16	150	D/7343-31	T598D157M016ATE065	240	10	65	1900	3	125	•
16	150	D/7343-31	T591D157M016ATE065	240	10	65	1900	3	125	
VDC at 105°C	µF	KEMET/EIA		µA at +25°C Max/5 Minutes	% at +25°C 120 Hz Max	mΩ at +25°C 100 kHz Max	mA at +45°C 100 kHz	Reflow Temp ≤ 260°C	°C	T598 Only <sup>1</sup>
Rated Voltage	Rated Cap	Case Code/ Case Size	KEMET Part Number	DC Leakage	DF	ESR	Maximum Allowable Ripple Current	MSL	Maximum Operating Temp	AEC-Q200 Qualified

<sup>1</sup> T598 = AEC-Q200 Qualified; T591 Series = Limited to 500 Hours at 85°C/85% RH Load

Refer to Ordering Information for additional detail.

**Table 1 – Ratings & Part Number Reference cont'd**

Rated Voltage	Rated Cap	Case Code/ Case Size	KEMET Part Number	DC Leakage	DF	ESR	Maximum Allowable Ripple Current	MSL	Maximum Operating Temp	AEC-Q200 Qualified
VDC at 105°C	µF	KEMET/EIA		µA at +25°C Max/5 Minutes	% at +25°C 120 Hz Max	mΩ at +25°C 100 kHz Max	mA at +45°C 100 kHz	Reflow Temp ≤ 260°C	°C	T598 Only <sup>1</sup>
20	47	D/7343-31	T591D476M020ATE050	94	10	50	2121	3	125	
25	22	D/7343-31	T591D226M025ATE060	55	10	60	1936	3	125	
25	33	D/7343-31	T598D336M025ATE060	82.5	10	60	1936	3	125	•
25	33	D/7343-31	T591D336M025ATE060	82.5	10	60	1936	3	125	
25	47	D/7343-31	T598D476M025ATE060	117.5	10	60	1936	3	125	•
35	10	D/7343-31	T598D106M035ATE120	35	10	120	1369	3	125	•
35	10	D/7343-31	T591D106M035ATE120	35	10	120	1369	3	125	
35	10	V/7343-20	T598V106M035ATE120	35	10	120	1248	3	125	•
35	10	V/7343-20	T591V106M035ATE120	35	10	120	1248	3	125	
35	22	D/7343-31	T598D226M035ATE065	77	10	65	1900	3	125	•
35	33	D/7343-31	T598D336M035ATE065	115.5	10	65	1900	3	125	•
35	33	D/7343-31	T591D336M035ATE065	115.5	10	65	1900	3	125	
35	33	X/7343-43	T598X336M035ATE065	115.5	10	65	1949	3	125	•
35	47	X/7343-43	T591X476M035ATE075	164.5	10	75	1815	3	125	
50	10	D/7343-31	T591D106M050ATE090	50	10	90	1581	3	125	
VDC at 105°C	µF	KEMET/EIA		µA at +25°C Max/5 Minutes	% at +25°C 120 Hz Max	mΩ at +25°C 100 kHz Max	mA at +45°C 100 kHz	Reflow Temp ≤ 260°C	°C	T598 Only <sup>1</sup>
Rated Voltage	Rated Cap	Case Code/ Case Size	KEMET Part Number	DC Leakage	DF	ESR	Maximum Allowable Ripple Current	MSL	Maximum Operating Temp	AEC-Q200 Qualified

<sup>1</sup> T598 = AEC-Q200 Qualified; T591 Series = Limited to 500 Hours at 85°C/85% RH Load  
 Refer to Ordering Information for additional detail.

## Derating Guidelines

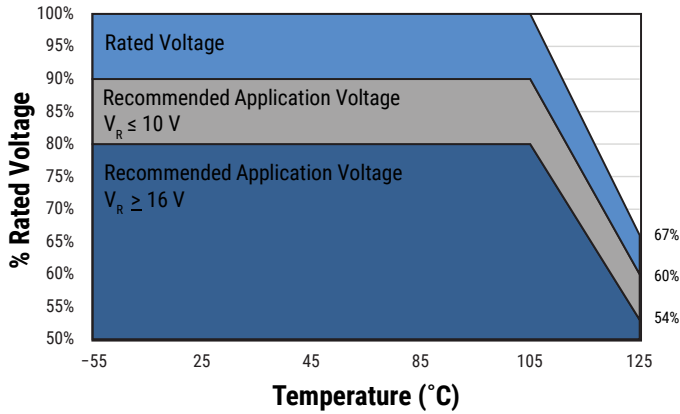

### Recommended Application Voltage

KOCAP's are solid state capacitors that demonstrate no wearout mechanism when operated within their recommended guidelines. While the KOCAP can be operated at full rated voltage, most circuit designers seek a minimum level of assurance in long term reliability which should be demonstrated with data.

A voltage derating can provide the desired level of demonstrated reliability based on industry accepted acceleration models. Since most applications do require long term reliability, KEMET recommends that designers consider a 10% voltage derating, according the graphic above, for the maximum steady state voltage.

Voltage Rating	Maximum Recommended Steady State Voltage	
	-55°C to 105°C	105°C to 125°C
$2.5\text{ V} \leq V_R \leq 10\text{ V}$	90% of $V_R$	60% of $V_R$
$V_R \geq 16\text{ V}$	80% of $V_R$	54% of $V_R$

$V_R$  = Rated Voltage



## Ripple Current/Ripple Voltage

Permissible AC ripple voltage and current are related to equivalent series resistance (ESR) and the power dissipation capabilities of the device. Permissible AC ripple voltage which may be applied is limited by two criteria:

1. The positive peak AC voltage plus the DC bias voltage, if any, must not exceed the DC voltage rating of the capacitor.
2. The negative peak AC voltage in combination with bias voltage, if any, must not exceed the allowable limits specified for reverse voltage. See the Reverse Voltage section for allowable limits.

The maximum power dissipation by case size can be determined using the table at right. The maximum power dissipation rating stated in the table must be reduced with increasing environmental operating temperatures. Refer to the table below for temperature compensation requirements.

Case Code	EIA Case Code	Maximum Power Dissipation (P max) mWatts at 45°C with +30°C Rise
B	3528-21	127
D	7343-31	225
V	7343-20	187

Using the P max of the device, the maximum allowable rms ripple current or voltage may be determined.

$$I(max) = \sqrt{P_{max}/R}$$

$$E(max) = Z \sqrt{P_{max}/R}$$

*I* = rms ripple current (amperes)

*E* = rms ripple voltage (volts)

*P max* = maximum power dissipation (watts)

*R* = ESR at specified frequency (ohms)

*Z* = Impedance at specified frequency (ohms)

Temperature Compensation Multipliers for Maximum Ripple Current		
T ≤ 45°C	45°C < T ≤ 85°C	85°C < T ≤ 125°C
1.00	0.70	0.25

*T* = Environmental Temperature

The maximum power dissipation rating must be reduced with increasing environmental operating temperatures. Refer to the Temperature Compensation Multiplier table for details.

## Surge Voltage

Surge voltage is the maximum voltage (peak value) which may be applied to the capacitor.

The surge voltage must not be applied for periodic charging and discharging in the course of normal operation and cannot be part of the application voltage.

Surge voltage capability is demonstrated by application of 1,000cycles at relevant voltage at 105°C and 125°C.

The parts are charged through a 33 Ohm resistor for 30 seconds and then discharged through a 33 Ohm resistor for each cycle.

Rated Voltage (V)	Surge Voltage (V)	Derated Voltage (V)	Derated Surge Voltage (V)
-55°C to 105°C		Up to 125°C	
2,5	3,3	1,7	2,2
6,3	8,2	4,2	5,5
10	13,0	6,7	8,7
16	20,8	10,7	13,9
20	26,0	13,4	17,4
25	32,5	16,8	21,8
35	45,5	23,5	30,5
50	65,	33,5	43,6

## Reverse Voltage

Polymer electrolytic capacitors are polar devices and may be permanently damaged or destroyed if connected in the wrong polarity. These devices will withstand a small degree of transient voltage reversal for short periods as shown in the below table.

Temperature	Permissible Transient Reverse Voltage
25°C	15% of Rated Voltage
55°C	10% of Rated Voltage
85°C	5% of Rated Voltage
105°C	3% of Rated Voltage
125°C*	1% of Rated Voltage

\*For series rated to 125°C

**Table 2 – Land Dimensions/Courtyard**

KEMET	Metric Size Code	Density Level A: Maximum (Most) Land Protrusion (mm)					Density Level B: Median (Nominal) Land Protrusion (mm)					Density Level C: Minimum (Least) Land Protrusion (mm)				
		Case	EIA	W	L	S	V1	V2	W	L	S	V1	V2	W	L	S
B	3528-21	2.35	2.21	0.92	6.32	4.00	2.23	1.80	1.12	5.22	3.50	2.13	1.42	1.28	4.36	3.24
D	7343-31	2.55	2.77	3.67	10.22	5.60	2.43	2.37	3.87	9.12	5.10	2.33	1.99	4.03	8.26	4.84
V	7343-20	2.55	2.77	3.67	10.22	5.60	2.43	2.37	3.87	9.12	5.10	2.33	1.99	4.03	8.26	4.84

**Density Level A:** For low-density product applications. Recommended for wave solder applications and provides a wider process window for reflow solder processes.

**Density Level B:** For products with a moderate level of component density. Provides a robust solder attachment condition for reflow solder processes.

**Density Level C:** For high component density product applications. Before adapting the minimum land pattern variations the user should perform qualification testing based on the conditions outlined in IPC standard 7351 (IPC-7351).

<sup>1</sup> Height of these chips may create problems in wave soldering.

<sup>2</sup> Land pattern geometry is too small for silkscreen outline.

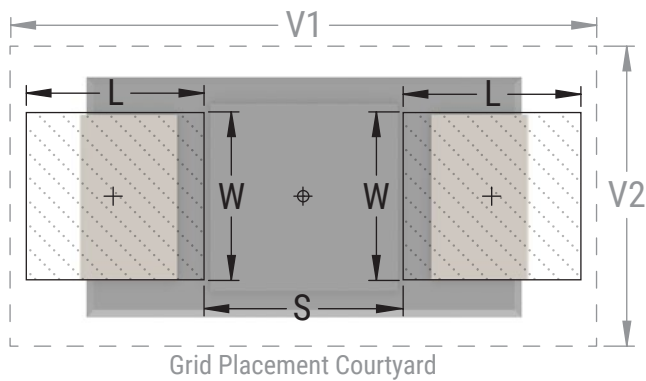

## Soldering Process

KEMET’s families of surface mount capacitors are compatible with wave (single or dual), convection, IR, or vapor phase reflow techniques. Preheating of these components is recommended to avoid extreme thermal stress. KEMET’s recommended profile conditions for convection and IR reflow reflect the profile conditions of the IPC/J-STD-020D standard for moisture sensitivity testing. The devices can safely withstand a maximum of three reflow passes at these conditions.

Please note that although the X/7343-43 case size can withstand wave soldering, the tall profile (4.3 mm maximum) dictates care in wave process development.

Hand soldering should be performed with care due to the difficulty in process control. If performed, care should be taken to avoid contact of the soldering iron to the molded case. The iron should be used to heat the solder pad, applying solder between the pad and the termination, until reflow occurs. Once reflow occurs, the iron should be removed immediately. “Wiping” the edges of a chip and heating the top surface is not recommended.

Profile Feature	SnPb Assembly	Pb-Free Assembly
<b>Preheat/Soak</b>		
Temperature Minimum ( $T_{smin}$ )	100°C	150°C
Temperature Maximum ( $T_{smax}$ )	150°C	200°C
Time ( $t_s$ ) from $T_{smin}$ to $T_{smax}$	60 – 120 seconds	60 – 120 seconds
Ramp-up Rate ( $T_L$ to $T_P$ )	3°C/seconds maximum	3°C/seconds maximum
Liquidous Temperature ( $T_L$ )	183°C	217°C
Time Above Liquidous ( $t_L$ )	60 – 150 seconds	60 – 150 seconds
Peak Temperature ( $T_P$ )	220°C* 235°C**	250°C* 260°C**
Time within 5°C of Maximum Peak Temperature ( $t_p$ )	20 seconds maximum	30 seconds maximum
Ramp-down Rate ( $T_P$ to $T_L$ )	6°C/seconds maximum	6°C/seconds maximum
Time 25°C to Peak Temperature	6 minutes maximum	8 minutes maximum

Note: All temperatures refer to the center of the package, measured on the package body surface that is facing up during assembly reflow.

\*Case Size D, E, P, Y, and X

\*\*Case Size A, B, C, H, I, K, M, R, S, T, U, V, W, and Z

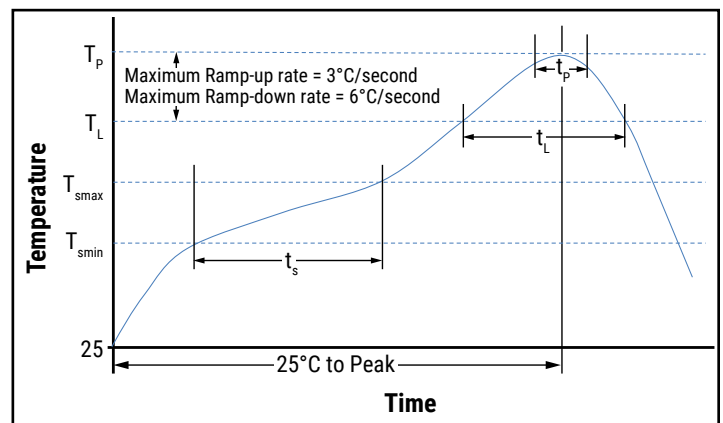

## Storage

All KO-Cap Series are shipped in moisture barrier bags (MBBs) with desiccant and humidity indicator card (HIC). These parts are classified as MSL3 (Moisture Sensitivity Level 3) per IPC/JEDEC J-STD-020 and packaged per IPC/JEDEC J-STD-033

MSL3 specifies a floor time of 168H at 30°C maximum temperature and 60% relative humidity. Unused capacitors should be sealed in a MBB with fresh desiccant.

Calculated shelf life in sealed bag:

- 12 months from bag seal date in a storage environment of <40°C and humidity <90% RH
- 24 months from bag seal date in a storage environment of <30°C and humidity <70% RH

If baking is required, refer to IPC/JEDEC J-STD-033 for bake procedure

## Construction

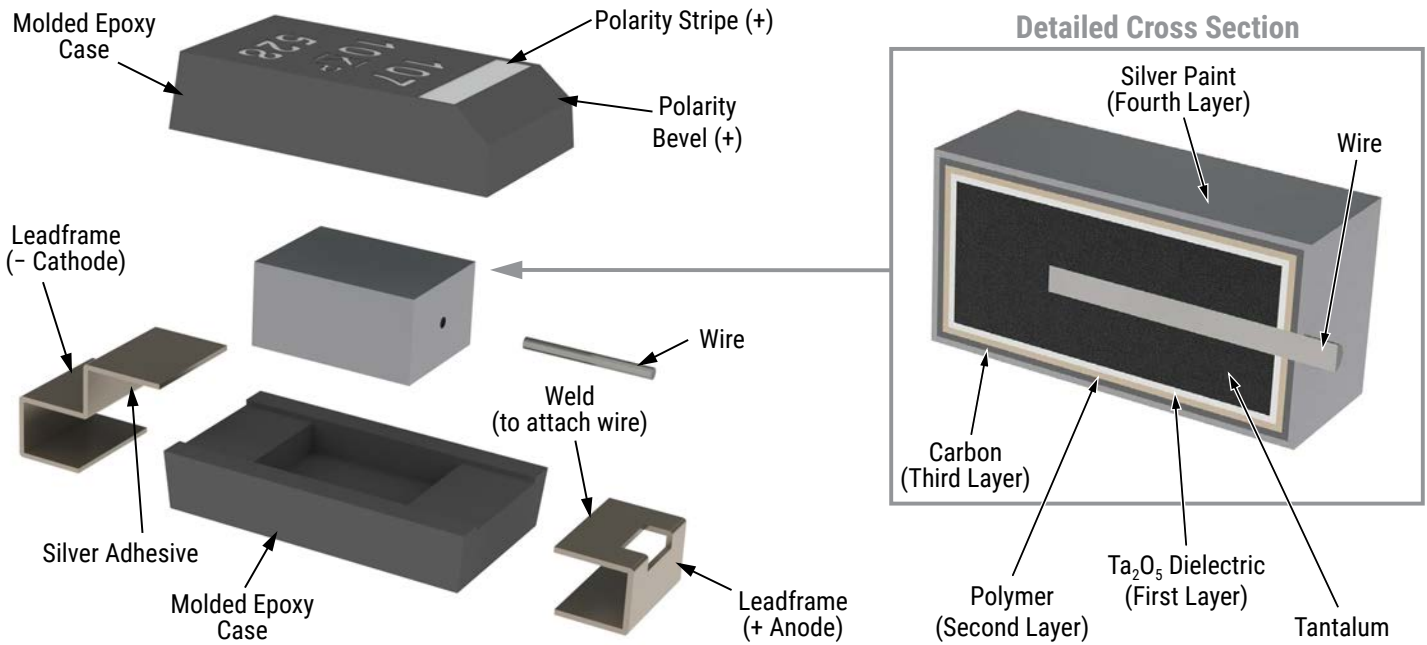

## Capacitor Marking

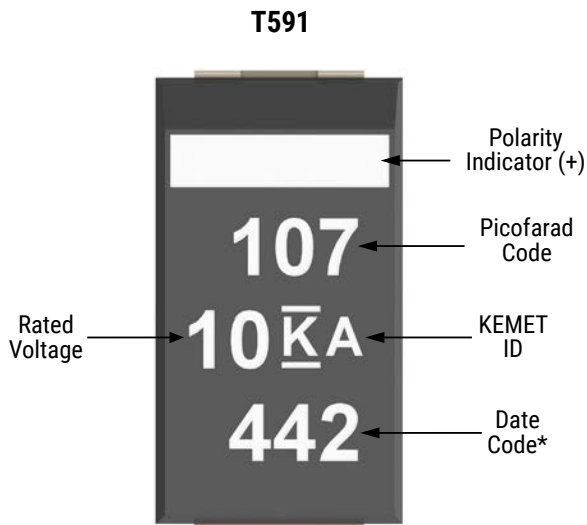

\* 442 = 42<sup>nd</sup> week of 2014

Date Code *	
1 <sup>st</sup> digit = Last number of Year	5 = 2015 6 = 2016 7 = 2017 8 = 2018
2 <sup>nd</sup> and 3 <sup>rd</sup> digit = Week of the Year	01 = 1 <sup>st</sup> week of the Year to 52 = 52 <sup>nd</sup> week of the Year

## Tape & Reel Packaging Information

KEMET’s molded chip capacitor families are packaged in 8 and 12 mm plastic tape on 7" and 13" reels in accordance with *EIA Standard 481: Embossed Carrier Taping of Surface Mount Components for Automatic Handling*. This packaging system is compatible with all tape-fed automatic pick-and-place systems.

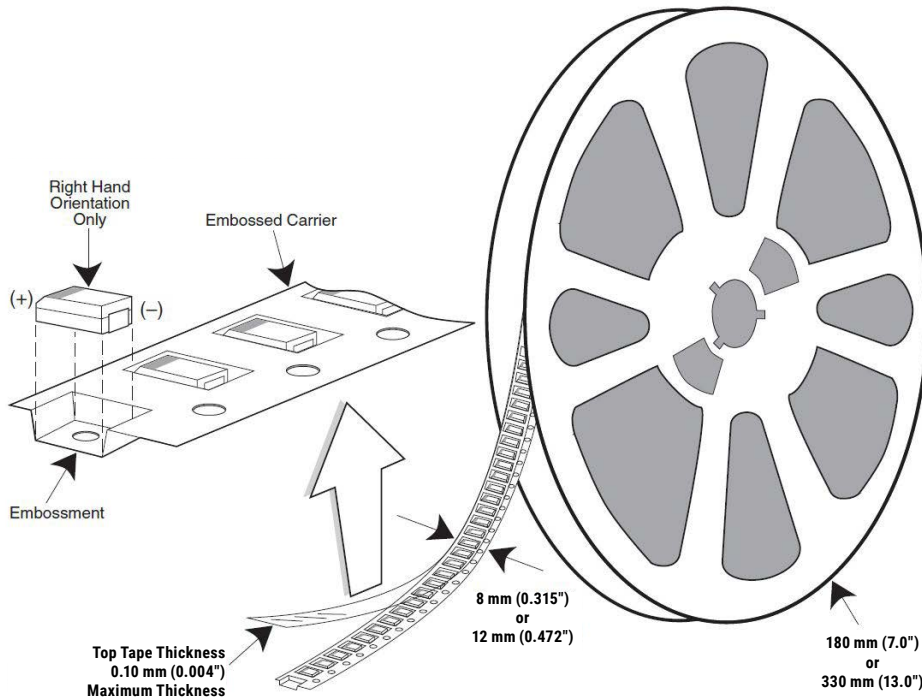
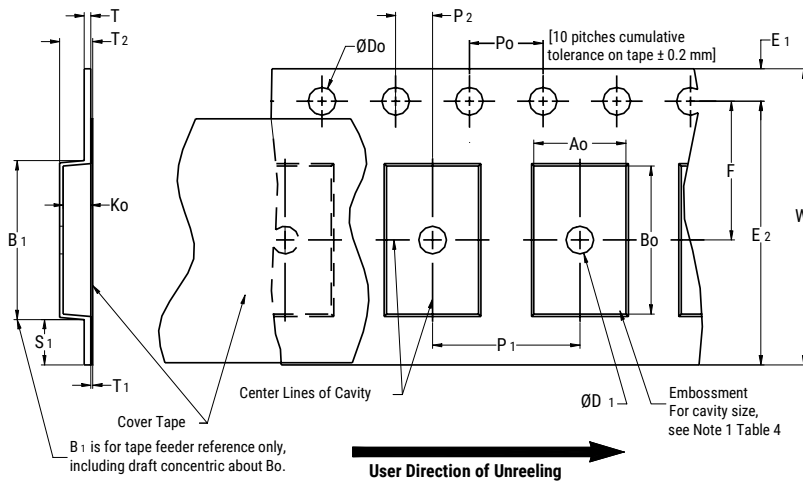

**Table 3 – Packaging Quantity**

Case Code		Tape Width (mm)	7" Reel*	13" Reel*
KEMET	EIA			
S	3216-12	8	2,500	10,000
T	3528-12	8	2,500	10,000
M	3528-15	8	2,000	8,000
U	6032-15	12	1,000	5,000
L	6032-19	12	1,000	3,000
W	7343-15	12	1,000	3,000
Z	7343-17	12	1,000	3,000
V	7343-20	12	1,000	3,000
A	3216-18	8	2,000	9,000
B	3528-21	8	2,000	8,000
C	6032-28	12	500	3,000
D	7343-31	12	500	2,500
Q	7343-12	12	1,000	3,000
Y	7343-40	12	500	2,000
X	7343-43	12	500	2,000
E/T428P	7360-38	12	500	2,000
H	7360-20	12	1,000	2,500

\* No C-Spec required for 7" reel packaging. C-7280 required for 13" reel packaging.

**Figure 1 – Embossed (Plastic) Carrier Tape Dimensions**



**Table 4 – Embossed (Plastic) Carrier Tape Dimensions**

Metric will govern

Constant Dimensions – Millimeters (Inches)											
Tape Size	D <sub>0</sub>	D <sub>1</sub> Minimum Note 1	E <sub>1</sub>	P <sub>0</sub>	P <sub>2</sub>	R Reference Note 2	S <sub>1</sub> Minimum Note 3	T Maximum	T <sub>1</sub> Maximum		
8 mm	1.5+0.10/-0.0 (0.059+0.004/-0.0)	1.0 (0.039)	1.75±0.10 (0.069±0.004)	4.0±0.10 (0.157±0.004)	2.0±0.05 (0.079±0.002)	25.0 (0.984)	0.600 (0.024)	0.600 (0.024)	0.100 (0.004)		
12 mm		1.5 (0.059)								2.0±0.1 (0.079±0.059)	30 (1.181)
16 mm											

Variable Dimensions – Millimeters (Inches)									
Tape Size	Pitch	B <sub>1</sub> Maximum Note 4	E <sub>2</sub> Minimum	F	P <sub>1</sub>	T <sub>2</sub> Maximum	W Maximum	A <sub>0</sub> , B <sub>0</sub> & K <sub>0</sub>	
8 mm	Single (4 mm)	4.35 (0.171)	6.25 (0.246)	3.5±0.05 (0.138±0.002)	2.0±0.05 or 4.0±0.10 (0.079±0.002 or 0.157±0.004)	2.5 (0.098)	8.3 (0.327)	Note 5	
12 mm	Single (4 mm) & Double (8 mm)	8.2 (0.323)	10.25 (0.404)	5.5±0.05 (0.217±0.002)	2.0±0.05 (0.079±0.002) or 4.0±0.10 (0.157±0.004) or 8.0±0.10 (0.315 ±0.004)	4.6 (0.181)	12.3 (0.484)		
16 mm	Triple (12 mm)	12.1 (0.476)	14.25 (0.561)	7.5±0.10 (0.295±0.004)	4.0±0.10 (0.157±0.004) to 12.0±0.10 (0.472±0.004)	8.0 (0.315)	16.3 (0.642)		

- The embossment hole location shall be measured from the sprocket hole controlling the location of the embossment. Dimensions of embossment location and hole location shall be applied independent of each other.
- The tape, with or without components, shall pass around R without damage (see Figure 4).
- If S<sub>1</sub> < 1.0 mm, there may not be enough area for cover tape to be properly applied (see EIA Standard 481–D, paragraph 4.3, section b).
- B<sub>1</sub> dimension is a reference dimension for tape feeder clearance only.
- The cavity defined by A<sub>0</sub>, B<sub>0</sub> and K<sub>0</sub> shall surround the component with sufficient clearance that:
  - the component does not protrude above the top surface of the carrier tape.
  - the component can be removed from the cavity in a vertical direction without mechanical restriction, after the top cover tape has been removed.
  - rotation of the component is limited to 20° maximum for 8 and 12 mm tapes and 10° maximum for 16 mm tapes (see Figure 2).
  - lateral movement of the component is restricted to 0.5 mm maximum for 8 mm and 12 mm wide tape and to 1.0 mm maximum for 16 mm tape (see Figure 3).
  - see Addendum in EIA Standard 481–D for standards relating to more precise taping requirements.

## Packaging Information Performance Notes

- 1. Cover Tape Break Force:** 1.0 Kg minimum.
- 2. Cover Tape Peel Strength:** The total peel strength of the cover tape from the carrier tape shall be:

Tape Width	Peel Strength
8 mm	0.1 to 1.0 Newton (10 to 100 gf)
12 and 16 mm	0.1 to 1.3 Newton (10 to 130 gf)

The direction of the pull shall be opposite the direction of the carrier tape travel. The pull angle of the carrier tape shall be 165° to 180° from the plane of the carrier tape. During peeling, the carrier and/or cover tape shall be pulled at a velocity of 300 ±10 mm/minute.

- 3. Labeling:** Bar code labeling (standard or custom) shall be on the side of the reel opposite the sprocket holes. Refer to EIA Standards 556 and 624.

## Figure 2 – Maximum Component Rotation



## Figure 3 – Maximum Lateral Movement

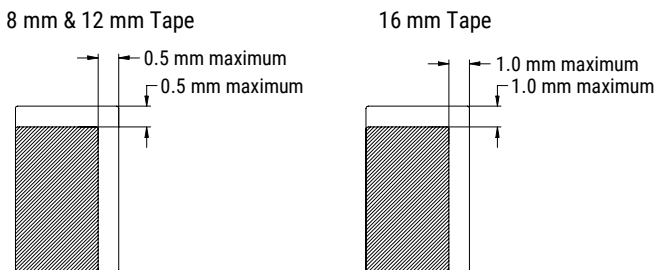

## Figure 4 – Bending Radius

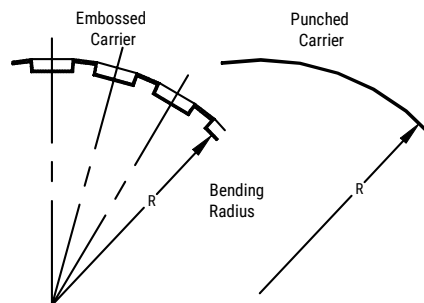



**Figure 5 – Reel Dimensions**

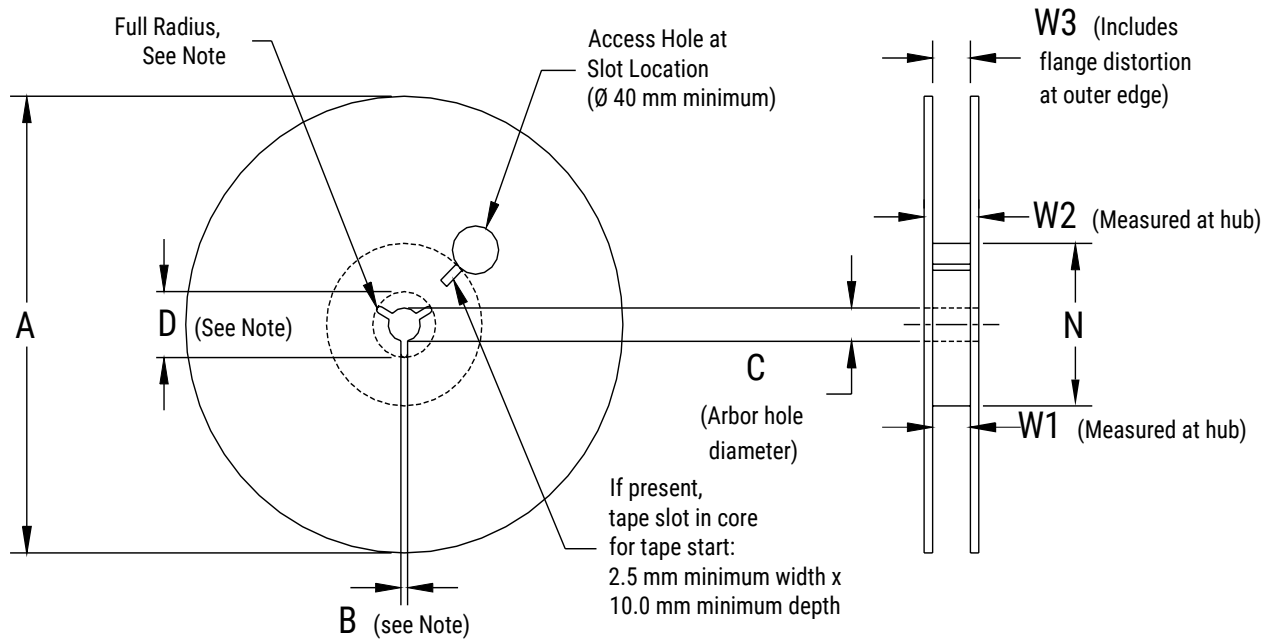

Note: Drive spokes optional; if used, dimensions B and D shall apply.

**Table 5 – Reel Dimensions**

Metric will govern

Constant Dimensions – Millimeters (Inches)				
Tape Size	A	B Minimum	C	D Minimum
8 mm	178±0.20 (7.008±0.008) or 330±0.20 (13.000±0.008)	1.5 (0.059)	13.0+0.5/-0.2 (0.521+0.02/-0.008)	20.2 (0.795)
12 mm				
16 mm				
Variable Dimensions – Millimeters (Inches)				
Tape Size	N Minimum	W <sub>1</sub>	W <sub>2</sub> Maximum	W <sub>3</sub>
8 mm	50 (1.969)	8.4+1.5/-0.0 (0.331+0.059/-0.0)	14.4 (0.567)	Shall accommodate tape width without interference
12 mm		12.4+2.0/-0.0 (0.488+0.078/-0.0)	18.4 (0.724)	
16 mm		16.4+2.0/-0.0 (0.646+0.078/-0.0)	22.4 (0.882)	

**Figure 6 – Tape Leader & Trailer Dimensions**

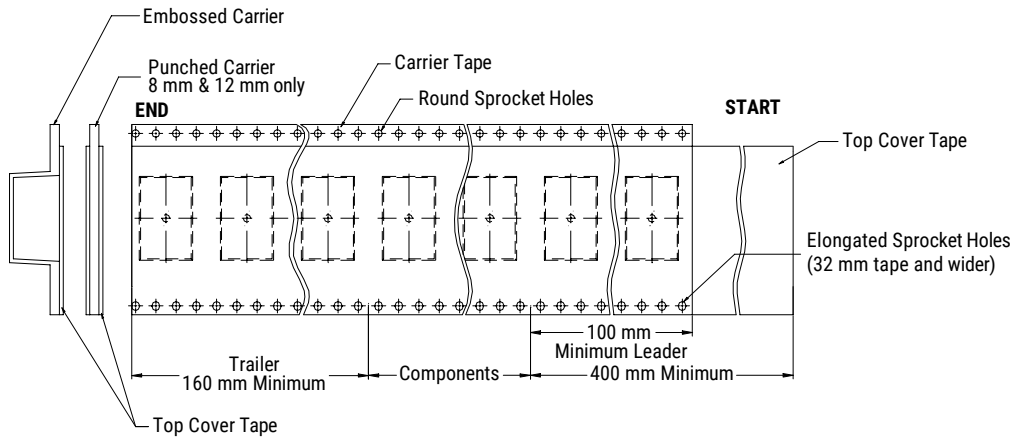

**Figure 7 – Maximum Camber**

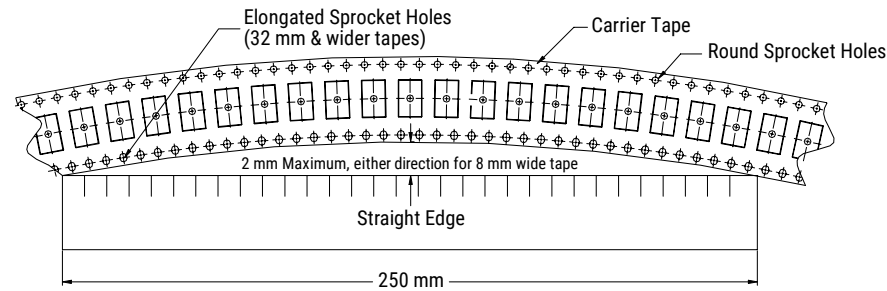

## KEMET Electronics Corporation Sales Offices

For a complete list of our global sales offices, please visit [www.kemet.com/sales](http://www.kemet.com/sales).

---

### Disclaimer

All product specifications, statements, information and data (collectively, the "Information") in this datasheet are subject to change. The customer is responsible for checking and verifying the extent to which the Information contained in this publication is applicable to an order at the time the order is placed.

All Information given herein is believed to be accurate and reliable, but it is presented without guarantee, warranty, or responsibility of any kind, expressed or implied.

Statements of suitability for certain applications are based on KEMET Electronics Corporation's ("KEMET") knowledge of typical operating conditions for such applications, but are not intended to constitute – and KEMET specifically disclaims – any warranty concerning suitability for a specific customer application or use. The Information is intended for use only by customers who have the requisite experience and capability to determine the correct products for their application. Any technical advice inferred from this Information or otherwise provided by KEMET with reference to the use of KEMET's products is given gratis, and KEMET assumes no obligation or liability for the advice given or results obtained.

Although KEMET designs and manufactures its products to the most stringent quality and safety standards, given the current state of the art, isolated component failures may still occur. Accordingly, customer applications which require a high degree of reliability or safety should employ suitable designs or other safeguards (such as installation of protective circuitry or redundancies) in order to ensure that the failure of an electrical component does not result in a risk of personal injury or property damage.

Although all product-related warnings, cautions and notes must be observed, the customer should not assume that all safety measures are indicated or that other measures may not be required.