

**Push-Pull Connectors
Cable Mounted Plug**

CCA Series

**Part Number: CCA1P1/A09
Pole: 9**

Illustration

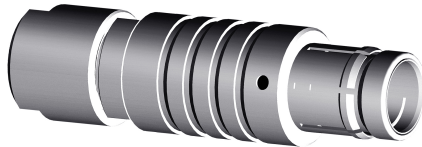

Size Drawing

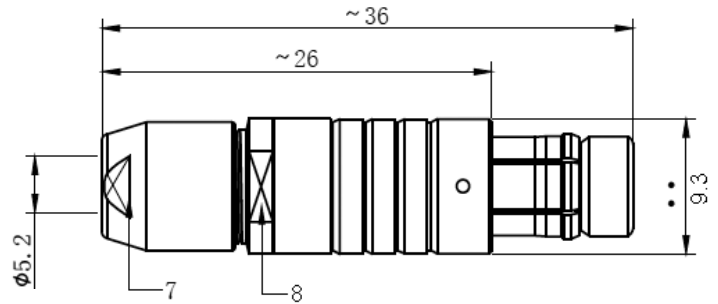

Insert Configuration

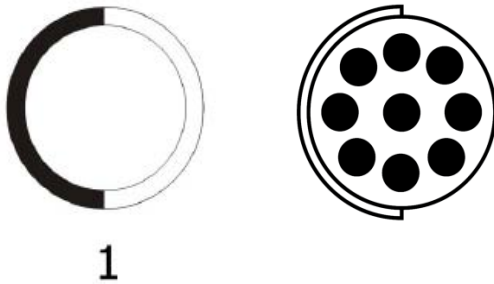

Technical Data

Common Values

Shell Style/Model:	Cable mounted straight plug, male contact
Codes:	Code 1
Contact Type:	Solder type
Contact Diameter:	0.5mm

Material

Housing Material:	Brass (natural chrome plated) shell and collet nut, nickel plated brass latch sleeve and mid pieces
Insulator:	PPS
Contacts:	Brass (Gold plated)

Electrical Values

Max. Stranded Conductor	AWG26-28
Max Diameter:	0.43mm
Vtest (contact-shell):	800V(AC) 1200V(DC)
Vtest (contact-contact):	1100V(AC) 1800V(DC)
Rated Current:	1.7A
Rated Voltage:	≤160V
Mechanical Operation:	5000 mating cycles

Others

Humidity (max):	≤95% [at 60 deg C /140 F]
Vibration:	15 g [10 Hz - 2000 Hz]
Shock Resistance:	100 g [6 ms]
Salt Spray Corrosion:	>72 hr
Climatical Category:	50/175/21
Shielding (min):	75 dB (10 MHz)
Shielding (min):	40 dB (1 GHz)
IP Rating:	68