

Polymer Aluminum, 125C, A700, 220 uF, 20%, 4 V, -55/+125C

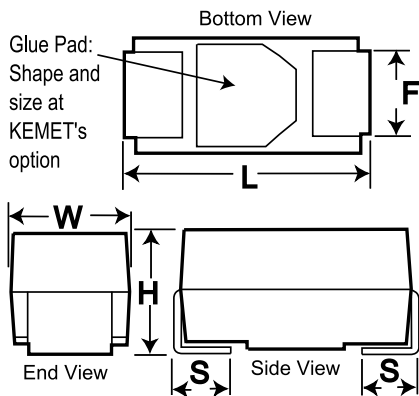

General Information	
Dielectric:	Polymer Aluminum
Style:	SMD Chip
Series:	A700
Footprint:	7343
Description:	Surface Mount, Polymer Aluminum
RoHS:	Yes
Termination:	Tin
Notes:	D/7343-31

Dimensions	
L	7.3mm +/-0.3mm
W	4.3mm +/-0.3mm
H	2.8mm +/-0.3mm
S	1.3mm +/-0.3mm
F	2.4mm +/-0.1mm

Packaging Specifications	
Weight:	196.58 mg
Packaging:	T&R, 180mm
Packaging Quantity:	500

Specifications	
Capacitance:	220 uF
Capacitance Tolerance:	20%
Voltage DC:	4 VDC
Temperature Range:	-55/+125C
Rated Temperature:	125C
Dissipation Factor:	6%
Resistance:	9 mOhms (100kHz)
Current:	5300 mAmps (100kHz)
Leakage Current:	52.8 uAmps (5min 20C)

Statements of suitability for certain applications are based on our knowledge of typical operating conditions for such applications, but are not intended to constitute - and we specifically disclaim - any warranty concerning suitability for a specific customer application or use. This Information is intended for use only by customers who have the requisite experience and capability to determine the correct products for their application. Any technical advice inferred from this Information or otherwise provided by us with reference to the use of our products is given gratis, and we assume no obligation or liability for the advice given or results obtained.