

Aluminum Electrolytic, 85C, ESK, 0.015 F, 20%, 25 V, -40/+85C, Lead Spacing = 10mm

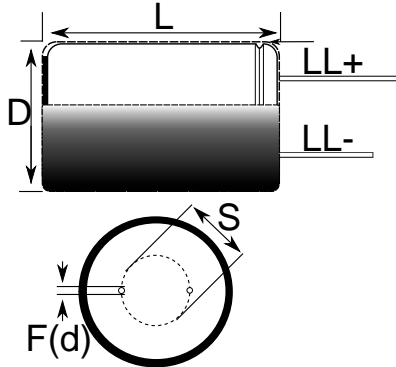

Note: '()' correspond to the letters used in the product bulletin

Dimensions	
D	22mm +/-0.5mm
L	40mm +2mm
S	10mm +/-0.5mm
LL Negative	15mm MIN
LL Positive	20mm MIN
F	0.8mm NOM

Packaging Specifications	
Packaging:	Bulk, Bag
Packaging Quantity:	300

General Information	
Dielectric:	Aluminum Electrolytic
Series:	ESK
Description:	Single Ended, Aluminum Electrolytic
RoHS:	Yes
Lead:	Wire Leads

Specifications	
Capacitance:	0.015 F
Capacitance Tolerance:	20%
Voltage DC:	25 VDC, 32 VDC (Surge)
Temperature Range:	-40/+85C
Rated Temperature:	85C
Life:	2000 Hrs
Dissipation Factor:	14% 120Hz 20C
Current:	3200 mAmps (120Hz 85C)
Leakage Current:	3750 uA (2min 20C)
Impedance Ratio at -25C:	3
Impedance Ratio at -40C:	4