

Aluminum Electrolytic, 85C, ESK, 22 uF, 20%, 25 V, -40/+85C, Lead Spacing = 2mm

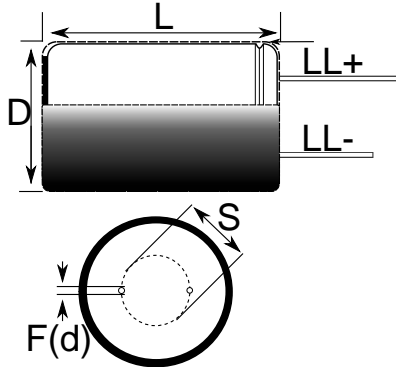

Note: '()' correspond to the letters used in the product bulletin

Dimensions	
D	5mm +/-0.5mm
L	11mm +1.5mm
S	2mm +/-0.5mm
LL Negative	15mm MIN
LL Positive	20mm MIN
F	0.5mm NOM

Packaging Specifications	
Packaging:	Bulk, Bag
Packaging Quantity:	10000

General Information	
Dielectric:	Aluminum Electrolytic
Series:	ESK
Description:	Single Ended, Aluminum Electrolytic
RoHS:	Yes
Lead:	Wire Leads

Specifications	
Capacitance:	22 uF
Capacitance Tolerance:	20%
Voltage DC:	25 VDC, 32 VDC (Surge)
Temperature Range:	-40/+85C
Rated Temperature:	85C
Life:	2000 Hrs
Dissipation Factor:	14% 120Hz 20C
Current:	90 mAmps (120Hz 85C)
Leakage Current:	5.5 uA (2min 20C)
Impedance Ratio at -25C:	3
Impedance Ratio at -40C:	4