

Ceramic, GoldMax, 6800 pF, 10%, 100 V, X7R, GoldMax, Commercial Standard, Lead Spacing = 2.54mm

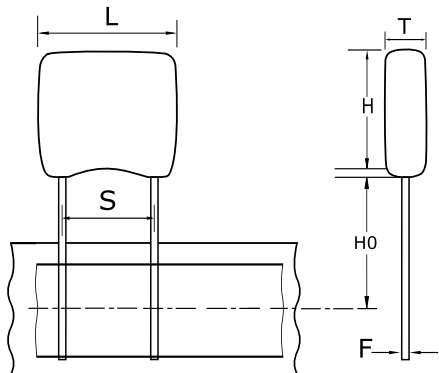

Dimensions

L	3.81mm MAX
H	3.14mm MAX
T	2.54mm MAX
S	2.54mm +/-0.78mm
LL	7mm MIN
H0	18mm MIN
F	0.51mm +0.1/-0.025mm

Packaging Specifications

Packaging:	T&R, 305mm
Packaging Quantity:	2500

General Information

Style:	Radial
Series:	GoldMax
Description:	GoldMax, Commercial Standard
RoHS:	Yes
Termination:	Tin
Failure Rate:	N/A
Halogen Free:	Yes

Specifications

Capacitance:	6800 pF
Capacitance Tolerance:	10%
Voltage DC:	100 VDC
Dielectric Withstanding Voltage:	250 V
Temperature Range:	-55/+125C
Temperature Coefficient:	X7R
Dissipation Factor:	2.5% 25C
Aging Rate:	3% Loss/Decade Hour
Insulation Resistance:	100 GOhms