

Ceramic, GoldMax, 4.7 uF, 20%, 50 V, Z5U, GoldMax, Commercial Standard, Lead Spacing = 5.08mm

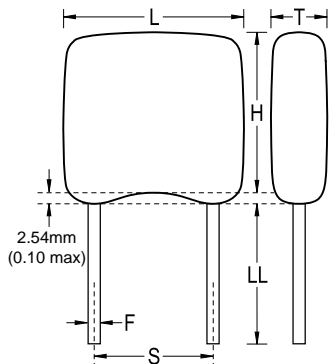

Dimensions

L	7.36mm MAX
H	10.16mm MAX
T	4.07mm MAX
S	5.08mm +/-0.78mm
LL	7mm MIN
F	0.51mm +0.1/-0.025mm

Packaging Specifications

Packaging:	Bulk, Bag
Packaging Quantity:	100

General Information

Style:	Radial
Series:	GoldMax
Description:	GoldMax, Commercial Standard
RoHS:	Yes
Termination:	Tin
Failure Rate:	N/A
Halogen Free:	Yes

Specifications

Capacitance:	4.7 uF
Capacitance Tolerance:	20%
Voltage DC:	50 VDC
Dielectric Withstanding Voltage:	125 V
Temperature Range:	+10/+85C
Temperature Coefficient:	Z5U
Dissipation Factor:	10% 25C
Aging Rate:	7% Loss/Decade Hour
Insulation Resistance:	20 MOhms