

KEMET Part Number: LDEEA1120KA0N00
(DEEA1120KA0N00)

Film, Metallized PEN Stacked, Commercial Grade, LDE, 1200 pF, 10%, 100 V, 63 V, 125C, 1206, 1.1mm

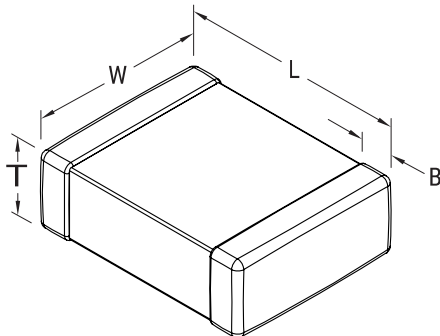

Dimensions	
Chip Size	1206
L	3.3mm +0.3/-0.1mm
W	1.7mm +/-0.2mm
T	1.1mm MAX
B	0.5mm +0.5/-0.3mm

Packaging Specifications	
Packaging:	T&R
Packaging Quantity:	3000

General Information	
Dielectric:	Metallized PEN Stacked
Style:	SMD Chip
Series:	LDE
RoHS:	Yes
Approvals:	AEC-Q200
AEC-Q200:	Yes

Specifications	
Capacitance:	1200 pF
Capacitance Tolerance:	10%
Voltage DC:	100 VDC
Voltage AC:	63 V
Temperature Range:	-55/+125C
Rated Temperature:	125C
Dissipation Factor:	0.8% 1kHz
Insulation Resistance:	1 GOhms
Max dVdt:	100 V